

The image features a central white oval on a blue background. Inside the oval, the text "Hands On!" is written in a large, bold, orange font, and "A Collection of ESL Literacy Activities" is written in a smaller, bold, blue font below it. Surrounding the oval are several hands of various skin tones (light brown, tan, and dark brown) reaching towards the center. The hands are rendered in a detailed, sketch-like style with visible lines and shading. The overall composition is circular and symmetrical, emphasizing the theme of unity and shared learning.

Hands On!

**A Collection of ESL
Literacy Activities**

ESL Special Project Funding Group

The ESL Special Project Funding Initiative is a collective and cooperative effort, led by the Nova Scotia Department of Education & Culture, with the involvement of a number of community groups and organizations. The main objective of this initiative is to make funding available to the immigrant serving community for the development and delivery of special projects.



The community groups involved in this initiative are as follows:

- Centre for Diverse Visible Cultures
- Halifax Immigrant Learning Centre
- Halifax Regional Library
- Metro ESL Association
- Metro Region Immigrant Language Services (MILS)
- Metropolitan Immigrant Settlement Association (MISA)
- Halifax Regional School Board, St. Pat's Adult ESL

Developed by Kathy Burnett

Halifax Immigrant Learning Centre

Suite 201, 7105 Chebucto Rd., Halifax, NS, B3L 4W8

Tel: (902)443-2937

Fax: (902)423-3154

Email: info@hilc.ns.ca

Available online at www.hilc.ns.ca

May be photocopied for classroom use.

Copyright 1999

Introduction

.....

Welcome to *Hands On! A Collection of ESL Literacy Activities*. This collection of activities was developed for instructors working with adult ESL learners who have had little or no opportunity to develop reading and writing skills.

The chapters focus on topics usually explored in any adult ESL class, although references are made to areas and names within Nova Scotia. Although the primary focus is to provide a thematic based approach to learning reading and writing, the activities will also serve as catalysts for speaking and listening activities. *Hands On!* is not a curriculum, but one of many resources that can be used to teach learners how to read and write.

Chapters 1–5 are in sequential order for learners at a very basic level. Each of these five chapters builds on the previous chapter. Chapters 6–14 are in no particular order and should be selected according to learners' level, needs and interests.

The directions on each page are written for instructors. Each page has a variety of activities that can be presented for that page. It is not recommended that all the suggested activities are attempted at one time, but that some are used for review.

Learners' confidence is an essential part of the learning process and as instructors, we should be aware of the possible lack of confidence and provide positive learning opportunities by focusing on learners' skills and abilities and ensuring successes in every class. The activities in this book were developed to be learner-centered and instructors are strongly encouraged to adapt and personalize the activities to reflect learners' own life experiences.

Vocabulary Development

It is important to develop oral vocabulary at the same time as learning reading and writing. Introducing new vocabulary or reinforcing words previously learned is the first activity in each chapter. When learners do the activities, it is important to have the information in front of them. Each time a new word is introduced, ask learners to copy it five to seven times. Every week, review what has been previously learned by looking at flyers, money, flash cards, talking about the weather, etc. Incorporating activities such as copying names, addresses, telling time, and saying phone numbers in class every day. Words can be written in a separate notebook, or on separate recipe cards and kept in a recipe box. The words at the end of each chapter in *Hands On!* can be cut and glued on to business cards for a more permanent resource.

The Alphabet

One of the first stages of ESL literacy is to become comfortable with the mechanical skills needed to write the alphabet. Tasks such as holding a pencil, drawing straight and curved lines, letter and number discrimination, and writing from left to right may be new challenges for learners. The first chapter in this book provides opportunities to develop and practice these skills.

Numeracy

Chapter 5 provides opportunities to develop basic numeracy skills. Even though numeracy is a survival skill, it is often overlooked in the ESL class. Developing numeracy skills is a long and continuous process. Although basic numeracy is introduced in this chapter, it is not meant to be a thorough presentation.

Lined literacy paper

Lined literacy paper is at the end of the first chapter and can be photocopied. The concept of writing on lines may be new and challenging to learners who have not had prior experience with writing. Forming the letters correctly, in proportion, and appropriately above and below the lines may also be new concepts. Aim for ease and flow before accuracy.

GENERAL ACTIVITIES

Language Experience

Language experience is a technique that provides learners with insights into the relationship between spoken and written language. Ask learners to tell a 'story' about what they did this morning or information about themselves. Instructors write the story as learners tell it. It can be as short as a few sentences, or longer, depending on the learners. Then ask learners to read the story, cut up the sentences, and ask learners to put the sentences in order. Then, cut up the individual words and ask learners to put the words in order to complete the sentence. Randomly point to individual words and ask learners to read the words. Instructors can also white out a few important words in the story. Have another copy of the story on hand for learners to refer to. Ask learners to fill in the blanks to complete the story. Language experience works well with learners who have a higher level of spoken English than written English.

Flash Cards

Most of the chapters have accompanying picture flash cards which are included at the back of the binder.

- Match the words found at the end of each chapter with the flash cards.
- Reinforce vocabulary orally by talking about the pictures on the flash cards.
- Arrange the flash cards in alphabetical order.

- Use to introduce or review vocabulary.
- Use to practice asking common questions (i.e. "Do you have any bananas?")
- Group cards into categories (i.e. likes and dislikes, have and don't have, in Canada and in my country, rooms of the house, meals, daily activities, etc).
- Introduce/review prepositions by saying or writing a sentence using a simple preposition and ask learners to place the flash cards in the same way. For example, instructors can say, "The lamp is beside the bed." Learners take the flash cards and place them beside each other.
- Write about the flash cards. If using the 'go shopping' flash card, learners can write or copy a sentence about shopping (i.e. "I go shopping on Saturday.")
- Describe an object and others guess what it is.

Making a Bingo Game

Number Bingo

- Photocopy the blank bingo card (at the end of the Food chapter) for as many learners as you have.
- Write numbers or words for numbers in the spaces on the Bingo card. You can ask learners to write the numbers or words on the card.
- Be sure to make every card different.
- Make a set of word cards that include all the words used on the Bingo cards. These can be used for the person calling out the words.

Word Bingo

- Photocopy the blank bingo card (at the end of the Food chapter) for as many learners as you have.
- Write the words in the spaces on the Bingo card or ask learners to write words on the card.
- Be sure to make every card different.
- Make a set of word cards that include all the words used on the Bingo cards. These can be used for the person calling out the words.

Picture Bingo

- Photocopy the blank bingo card (at the end of the Food chapter) for as many learners as you have.
- Reduce and photocopy the pictures you want to put on the cards.
- Cut out the pictures and glue them on the card.
- Be sure to make every card different.
- Make an extra set of picture cards that includes all the pictures used on the cards. These can be used for the person calling out the words. These can also be words for the pictures.

Board Games

You will need dice and something to move around the board representing each player. There are many ways to use these game boards

Alphabet Board Game

The purpose of these activities is to provide an opportunity to practice recognizing and saying the names of the letters.

Suggestions:

- Players roll the dice, land on a letter, and say the letter.
- Players roll the dice, land on a letter, and write the same letter.
- Players roll the dice, land on a letter, and write the same letter in upper case.
- Players roll the dice, land on a letter, and say the letter that comes next in the alphabet.
- Players all have the letters of the alphabet in front of them on a paper.
- Players roll the dice, land on a letter, and circle the same letter on their paper.
- Players write their name on a paper. When the players land on a letter that is in their name, they circle the letter.
- Each player has a set of alphabet cards. Players roll the dice, land on a letter and matches the letter with a card.

- Players have one set of alphabet cards. Players roll the dice, land on a letter, and find the card from the communal set.
- Players roll the dice, land on a letter, and say a word that begins with that letter.
- Players roll the dice, land on a letter, and say all the words that begin with that letter.

Time Board Game

The purpose of this activity is to provide an opportunity to practice reading the time and to practice talking about daily activities.

Suggestions:

- Players roll the dice. If a player land on a clock, someone asks, "What time is it?" The player responds by saying the time, "It's 4:00." The player then can ask others, "What do you do at 4:00?" Players then talk about their daily activities.
- For this activity the group needs a clock. Players roll the dice. If a player land on a picture of a verb, the player says the verb (i.e. "get up"). Then she asks others, "What time do you get up?" The player takes the clock and arranges the hands on the clock to represent the time she does the activity. She says, "I get up at 7:00."
- The instructor writes the words from the game board on separate pieces of paper. The instructor also writes the times that are shown on the game board. Players have the words and the times in front of them. Players roll the dice. When they land on a time, they find the written time on their paper and say the time. When they land on a picture, they find the word for the picture and read the word.

Your Comments

We are interested in your evaluation of *Hands On! A Collection of ESL Literacy Activities*. Please complete and mail this page back to us at the following address:

Hands On!
P.O. Box 22095
Bayers Road RPO
Halifax, Nova Scotia
B3L 4T7

How often do you use activities from *Hands On! A Collection of ESL Literacy Activities*?

What do you like most about the activities?

What do you like least about the activities?

What other topics would you like to see included?

What specific suggestions do you have to improve the content of *Hands On!*?

Do you have any other comments?

Thank you for your input!

ABCs

How do you spell...?

Objective

To introduce the Roman alphabet.

Goals

- To reinforce left to right eye coordination.
- To manipulate a pencil or marker.
- To form the letters.
- To introduce lines and the function of lined paper.
- To recognize and identify upper and lower case letters.
- To request spelling.

Suggestions

- Alphabet cards are essential! Make or buy alphabet flash cards. They are readily available for a reasonable price. If you make the flash cards, ensure that they are clear and are all the same size. Use both lower case and upper case letters.
- Learning the letters is a slow process that requires a lot of supervision time. If you are in a classroom environment, volunteers can be helpful.
- Demonstrate how to form a letter. Draw a letter in the air or with your finger in sand. Trace a letter with your finger. When first holding pencil practice drawing. Aim for ease and flow before accuracy.
- Focus on the letters that have the most meaning to learners. Use letters in their name, address, family members' names or their country.
- Introduce a few letters at a time. It can be overwhelming for learners if given all the letters at the same time. Some people recommend teaching letters in groupings. Groupings include letters with slanted lines (w x k v z), letters with straight lines (i l f t), letters with curved lines (a b c o d e s), letters with straight and curved lines (m n u r h), and letters that go below the line (y p q g j).

- Identify key words that are pronounced as letters such as VCR, TV, OK, YMCA, CBC, PEI, IWK, and practice spelling and recognition. Learners may already know these words but need practice in identifying the letters.
- When a letter is introduced, immediately place it in a word.
- Don't write on the board in all capital letters unless you are specifically learning capital letters.
- If you are using a computer to create worksheets, choose a simple font.
- Have an activity each day that provides an opportunity for responding to the question, "How do you spell that?" Learners say the spelling as well as write the word (e.g. name, address, town, city or province name, children's name).
- Educational material companies have products to assist in learning the alphabet. (See resource list in back for more information.)
- Use the lined literacy paper at the end of this chapter to practise forming the letters.

Ensure success in every class.

Activities

- Manipulate the letters, practice name of letters, match letters, form words with the letters.
- Have two sets of lower case alphabet cards. Match the same letters together.
- Have two sets of upper case alphabet cards. Match the same letters together.
- Have one set of upper case and one set of lower case alphabet cards. Match the same letters together.
- Instructor or learner writes about ten letters on a page. Someone says a letter and learners circles the letter she hears.

- Write about ten letters on a page. Show the class a letter and they find it on their paper.
- You spell a word that is meaningful to learners. learners writes the word.
- Create an Alphabet Bingo activity by putting letters on the blank Bingo card provided in this kit. Either you or a learner can call out the letters, learners in the class recognize the letters and cover the letter on their Bingo card.
- Have a variety of letters on the page and ask learners to connect the letters in alphabetical order.
- Word searches can be hand made or created with word search computer programs. These programs are readily available as well.
- Put the alphabet cards in alphabetical order.
- Phonic activities can be created using letters and sounds that are important to learners. Teaching phonetics can be challenging since some ESL literacy learners have not developed a lot of vocabulary yet. Therefore it is important to use phonetics found in words that are familiar to learners such as learners's name, names of family members, names of other people in the class, country names, etc. The instructor can elicit words that have the same first letter. After a few different sounds are recognized, the instructor writes these words on a paper and leaves a blank in place of the first letter. The instructor or a more advanced learner reads the first word and learners fill in the blank. If pictures of these words are available, you can make a worksheet that includes the picture with the word beside it with a blank in place of the first letter. learners look at the picture and say the word and fill in the blank. You can do the same activity with final consonants and blends.
- Singing the "alphabet song" provides melodic groupings of letters and reinforces the names and order of the letters.

Alphabet Concentration

Have one set of upper case letters and one set of lower case letters. Lay them face down on a table. Each person takes turns turning over two cards and saying the letter as they turn it over. If the cards do not match, return them to their face-down position and the next person tries. The goal is to get two letters the same. This reinforces the names of the letters through repetition as well as provides an opportunity to familiarize learners with the letters. When you do this activity, begin with fewer cards so it is a more manageable task for learners.

Alphabet Fish

Pre-teach the question, "Do you have a 'k'?" and "Yes, here you are". Or "No, sorry I don't." Have two sets of alphabet cards. Deal a few cards to each player. Put the remaining cards upside down in the middle of the table. One person starts by choosing a card in their hand and asking if another person has that card. He asks, "Do you have an 'o'?" If the answer is "yes", the person gives the asker the card and he puts it together with his card on the table. If the answer is "no", the asker picks up a card from the pile of cards in the middle of the table. The idea is to get pairs of letters. This reinforces the recognition as well as the names of the letters.

Alphabet Board Game

See introduction for description.

Instructors can:

- write a familiar word. Ask learners to point to the letters in that word.
- write a familiar word. Ask learners to trace letters in that word.
- cut up these letters and give learners the cut-up letters. Also give learners a copy of this sheet. Ask learners to match the letters.
- ask learners to identify where a certain letter is in the alphabet – whether it is at the beginning, middle or end.

Learners can:

- trace the letters with a thick marker.
- trace only the letters in their name.
- cut up the letters and find the letters in his name.
- match the cut-up letters in his name to the letters on this sheet.
- put the cut-up letters in alphabetical order.



Instructors can:

- write a familiar word. Ask learners to point to the letters in that word.
- write a familiar word. Ask learners to trace letters in that word.
- cut up these letters and give learners the cut-up letters. Also give learners a copy of this sheet. Ask learners to match the letters.
- ask learners to identify where a certain letter is in the alphabet — whether it is at the beginning, middle or end.

Learners can:

- trace the letters with a thick marker.
- traces only the letters in their names.
- cut up the letters and find the letters in his name..
- match the cut-up letters in his name to the letters on this sheet.
- put the cut-up letters in alphabetical order.



a	b	c	d
e	f	g	h
i	j	k	l
m	n	o	p

q	r	s	t
u	v	w	x
y	z		

A	B	C	D
E	F	G	H
I	J	K	L
M	N	O	P

Q	R	S	T
U	V	W	X
Y	Z		

LETTER RECOGNITION**Instructors can:**

- say a letter and ask learners to circle it
- show a letter and ask learners to circle it.
- create a similar worksheet using upper case letters.
- create a similar worksheet using both upper and lower case letters.

Learners can:

- circle the same letter.
 - copy the letters on a separate page.
 - copy the letters on a separate page and change them to upper case.
 - circle the letters that are in her name.
 - dictate the letters to each other.
-

h b h n m u h t y p h

d p d o b q a t g d b

n u m n u h a b n o m

g y p g a c d q g e g

a b o a q d a u c a g

f t f l j f h k f l h

p d p o b p q e c p b p

b d p b g l o b q h b

v w u v y v x z w v r

LETTER RECOGNITION

Instructors can:

- say the letters and ask learners to circle them.
- show the letters to the learners and ask them to circle the same letters.
- create a similar worksheet using upper case letters.
- create a similar worksheet using both upper and lower case letters.
- create a similar worksheet using familiar words.

Learners can:

- circle the same letters.
 - copy the letters on a separate page.
 - copy the letters on a separate page and changes them to upper case.
 - circle the letters that are in her name.
 - dictate the letters to each other.
-

at af ot at qa dt at al of

be de pe eb eg be le oe be

ch cn hc oh dc ch cu hc ch

dr pr rf dr rd or br qn dr

ea ae ca ea ee ce oe ea ea

fe te ef fe fc le je fo el

go yo op go ga og do qo go

it il ti it ij if fi ft ij

ju iu lu uj tu fu gu ju jy

Instructors can:

- say a letter and ask learners to point to it.
- show the learners a letter and ask learners to point to it.
- show the learners a letter and ask learners to say it.
- show the learners a letter and ask learners to write it.

Learners can:

- write the same letter in the blank.
 - write the upper case letter in the blank.
 - write the letter that comes after each letter in the blank.
-

a _____

b _____

c _____

d _____

e _____

f _____

g _____

h _____

i _____

j _____

k _____

l _____

m _____

n _____

o _____

p _____

q _____

r _____

s _____

t _____

u _____

v _____

w _____

x _____

y _____

z _____

Instructors can:

- say a letter and ask learner to point to it.
- say a letter and ask learner to circle it.

Learners can:

- fill in the blanks with the missing letters.
 - dictate the letters to each other and fill in the blanks.
 - work in pairs. One learner has the alphabet with some letters blanked out. Another learner has a set of alphabet cards. The learner with the blanked alphabet asks the other learner for the missing letters.
-

a b c d e f g h i j k l m n o p q r s t u v w x y z

a b c _ e f _ h i j _ l m _ o p q _ s t u _ w x _ z

a _ c d _ f g h i j k l _ _ n o _ q r s _ u v _ _ x _ z

_ b c d e _ _ h _ j k _ m n _ p q r _ t u v w _ _ z

a _ c _ e _ g _ i _ k _ m _ o _ q _ s _ u _ w _ y _

Instructors can:

- say a letter and ask learner to point to it.
- say a letter and ask learner to circle it.

Learners can:

- fill in the blanks with the missing letters.
- dictate the letters to each other and fill in the blanks.
- work in pairs. One learner has the alphabet with some letters blanked out. Another learner has a set of alphabet cards. The learner with the blanked alphabet asks the other learner for the missing letters.

A B C D E F G H I J K L M N O P Q R S T U V W X Y Z

A B C _ _ E F _ _ H I J _ _ L M _ _ O P Q _ _ S T U _ _ W X _ _ Z

A _ _ C D _ _ F G H I J K L _ _ N O _ _ Q R S _ _ U V _ _ X _ _ Z

_ _ B C D E _ _ _ _ H _ _ J K _ _ M N _ _ P Q R _ _ T U V W _ _ _ _ Z

A _ _ C _ _ E _ _ G _ _ I _ _ K _ _ M _ _ O _ _ Q _ _ S _ _ U _ _ W _ _ Y _ _

Instructors can:

- show learners upper case letter cards and ask learners to write the letter in the blank.

Learners can:

- fill in the blanks with the upper case letters.
 - fill in the blanks with the same letter.
-

a ___ b ___ c ___

d ___ e ___ f ___

g ___ h ___ i ___

j ___ k ___ l ___

m ___ n ___ o ___

p ___ q ___ r ___

s ___ t ___ u ___

v ___ w ___ x ___

y ___ z ___

Instructors can:

- show learners lower case letter cards and ask learners to write the letter in the blank.
- create a worksheet using both upper and lower case letters.

Learners can:

- fill in the blanks with the lower case letters.
- fill in the blanks with the same letter.

A ___ B ___ C ___

D ___ E ___ F ___

G ___ H ___ I ___

J ___ K ___ L ___

M ___ N ___ O ___

P ___ Q ___ R ___

S ___ T ___ U ___

V ___ W ___ X ___

Y ___ Z ___

Instructor can:

- say a letter and ask learners to circle all of those letters.

Learners can:

- circle letters from his name.
 - circle all the a's with a blue marker, all the b's with a green marker, and so on.
-

a q y i y o p l b y t m
r e w a z v t i u n p i
i u h g f n l o p y u r
q w e r t y u i o o p l
l k j h g f d s a m n b
v c x z a q w s c d y t

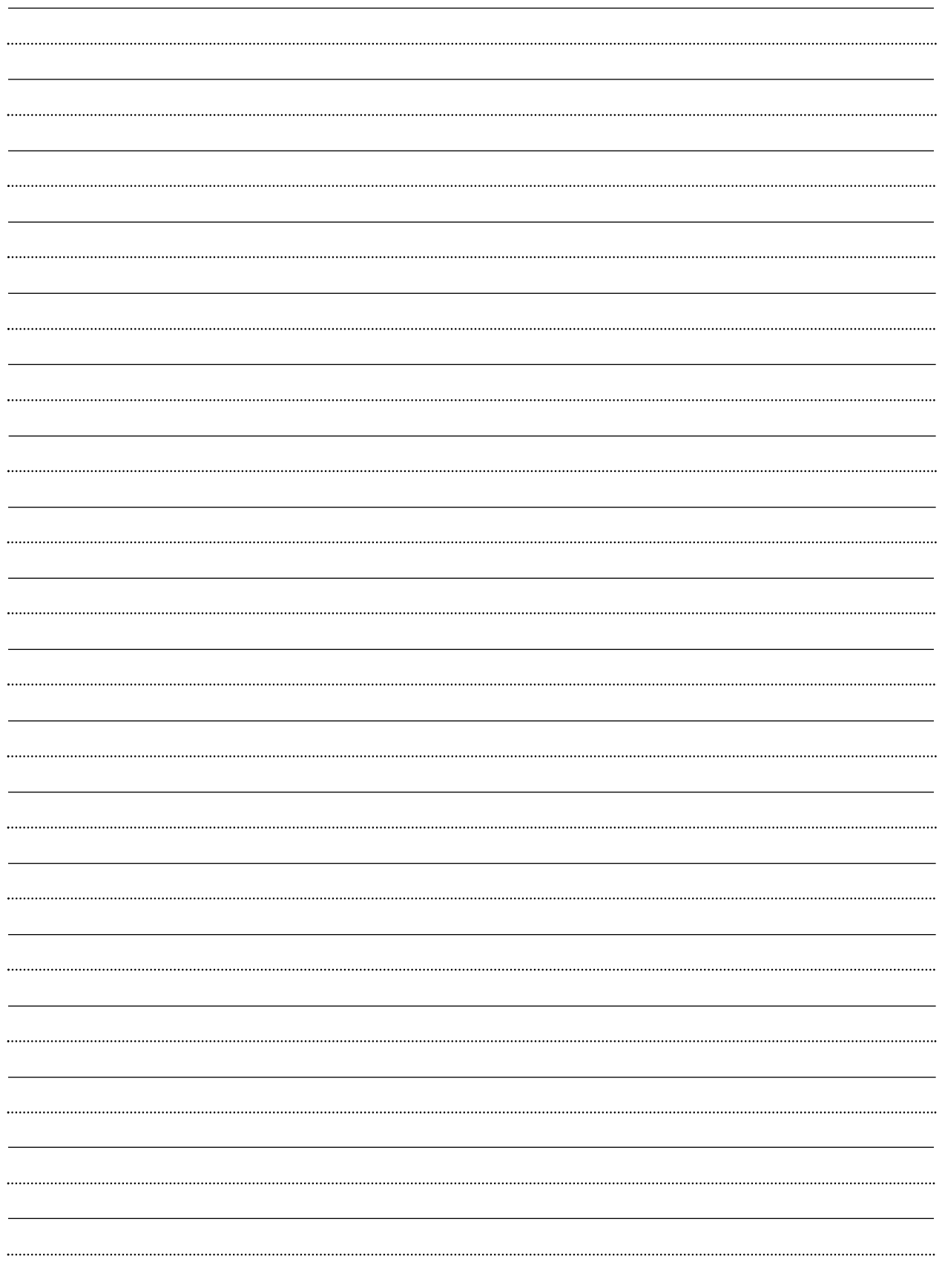

NUMBERS

What's your telephone number?



Objective

To introduce numbers.

Goals

- To reinforce left to right eye coordination.
- To form the numbers.
- To recognize and identify numbers.
- To request and to respond to requests for telephone numbers.
- To request and respond to requests for, "How many ___?"; "How old ___?"

Suggestions

- Number flash cards are very useful. Make or buy number flash cards. They are readily available for a reasonable price. If you make the flash cards, ensure that they are clear and are all the same size.
- Introduce a few numbers at a time as not to overwhelm learners.
- Draw the numbers in the air or in sand with finger.
- Trace numbers with finger.
- If you are using a computer to create worksheets, use a simple font.
- Identify numbers that are important to the learner (e.g. phone, apartment, family members, social insurance, emergency, bus, license plate, etc.) and reinforce these numbers until learners are comfortable using them.
- Ask and respond to the question, "What's your phone number?"
- Ask and respond to the question, "How many ___?"

- Ask and respond to the question, "How old ___?"
- Create opportunities for learner to be familiar with the various styles of numbers. Pay particular attention to 1, 2, 4, 7, and 9.

Activities

- Practice forming the numbers using the lined paper in this kit.
- Manipulate number flash cards. Practice name of numbers, put the numbers in order, trace the numbers.
- Have a paper with a series of numbers on it. Blank out some of the numbers and learner fills in the blanks.
- Have a set of numbers and learner picks out the numbers in her phone number or address.
- Instructor shows or says a number, learner identifies it from his assortment of numbers.
- Instructor says a number or a series of numbers, learner writes the number(s).
- Learner or instructor writes a variety of numbers on a paper. Ask the learner to connect the numbers in numerical order.
- Learner asks partner or other people in the class, "What is your phone number?" Learner listens and writes their number down. You can reinforce spelling by asking learners to write the person's name and ask how to spell it, and then their telephone numbers. Or, have the learner's phone numbers on cards, and when they ask each other, the learner has to pick out the correct one.

- Have a telephone on hand so learners can become familiar with the numbers on the phone. Instructor or another learner can say a telephone number and the learner pushes the numbers on the phone.
- Instructor writes names of learner's family members and learner fills in the blank with the age. (e.g. Ahmed is __ years old.)
- Have a set of number cards as well a set of cards with the word of the number on them. Match the number with the word.
- Ask simple "how many" questions. Learner writes the number as his answer.
- You can use this opportunity to enhance or reinforce vocabulary already learned by asking, "How many sweaters/pencils/bedrooms do you have?"

Number Bingo

Create your own set of Number Bingo cards by copying the blank Bingo Card in this kit. Ask learners to fill in the spaces with numbers. Learner or instructor calls out the numbers, other players cover the numbers as they hear them. A variation of this is to write the number words in the spaces. You can also use old calendar pages for Bingo cards.

Number Fish

Pre-teach the question, "Do you have a 3?" and "Yes, here you are" or "No, sorry, I don't." Have two sets of number cards or a regular pack of cards without the Jack, Queen, King, and ace. Deal a few cards to each player. Put the remaining cards upside down in the middle of the table. One person starts by choosing a card in their hand and asking if another person has that card. He asks, "Do you have a 10?" If the answer is "yes", the person gives the asker the card and he puts it together with his card on the table. If the answer is "no", the asker picks up a card from the pile of cards in the middle of the table. The idea is to get pairs of numbers. This reinforces the recognition as well as the names of the numbers.



Instructors can:

- say a number and ask learner to trace it.

Learners can:

- trace numbers with a marker.
 - cut up the numbers and put them in order.
-

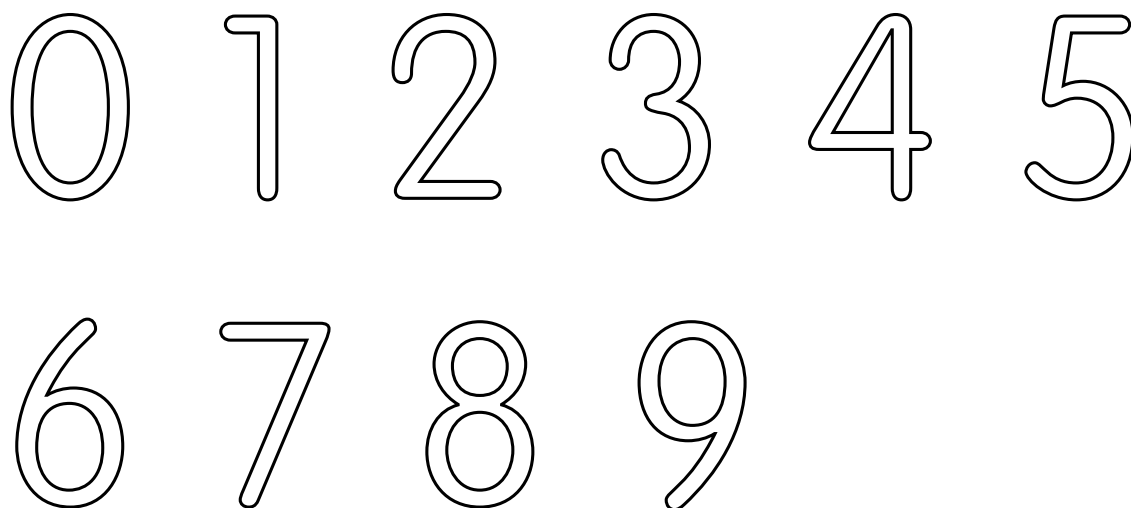

Read the number and circle the same number of squares.

3



5

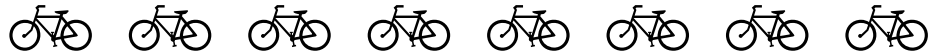

8



1



4



7



9



2



0	zero
1	one
2	two
3	three
4	four
5	five
6	six
7	seven
8	eight
9	nine
10	ten

Circle the words.

0 zero erozrozerozarozrrozerozorzcro

1 one oncneoenoneoncecononeenno

2 two wtotwotlwowmetowtwoowu

3 three theertheethreeefhreethreeer

4 four fivetourfourforfurfoorfonrfourfo

5 five fveifvefiveififefvefivefevifvieve

6 six sisxsiksixsisisisiixissixxisixisix

7 seven senvensevensenesevenseven

8 eight eigteghteightelghtetghgheigh

9 nine ninninenienenenineieniennniue

10 ten tcntantintennetnetntennteente

Instructors can:

- say a number and ask learners to circle it.
- show a number and learner circles it.
- create similar worksheets using other numbers as learners are ready.

Learners can:

- circle the same number.
- copy the numbers on a separate page.
- circle the letters that are in their telephone numbers or addresses.
- dictate the numbers to each other.
- work in pairs. One learner has a set of number cards, the other learner asks for a number.

0	five	ten	one	zero
1	six	nine	one	four
2	nine	two	five	seven
3	one	eight	three	ten
4	four	two	one	six
5	six	five	nine	ten
6	three	eight	four	six
7	one	seven	ten	nine
8	one	zero	nine	eight
9	ten	nine	five	seven
10	zero	ten	six	one

Instructors can:

- say the numbers and ask learners to fill in the blanks.

Learners can:

- work in pairs and read the numbers to each other and put the missing number in the blank.
-

1 2 3 ___ 5 6 7 8 ___
10 11 12 ___ 14 15 16 ___ 18
19 20 21 ___ 23 24 25 ___ 26
27 28 ___ 30 31 32 ___ 34 35
36 ___ 38 39 ___ 41 42 ___ 44
___ 46 47 48 ___

Instructors can:

- say a number and ask learners to circle it.

Learners can:

- copy the numbers on a separate paper.
- circle the biggest number in each row.
- circle the smallest number in each row.

7 2 9 3 6 8 4 1 5

11 10 15 19 16 12 13 14 17

27 20 29 25 28 23 21 24 30

30 23 32 27 36 26 22 26 29

7 2 9 3 6 8 1 5 4

11 10 15 19 16 12 14 18 13

27 20 29 25 28 23 22 24 26

30 23 32 27 36 26 32 21 20

1 – 100 NUMBER BOARD**Instructors can:**

- say a number and ask learners to point to it.
- show a number and ask learner to point to it.
- show a number and ask learner to write it.
- blank out some numbers and ask learners to fill in the blanks.
- enlarge the numbers so it is easier to manipulate if you cut it up.

Learners can:

- cut up the numbers, learner puts them in order.
- circle the ages of the people in the class.
- circle the ages of their children, parents or siblings.
- trace the numbers.
- copy the numbers onto a blank number board.
- copy the number board and cut out one set of numbers. Learners then match their cut out numbers with those on the board.

1	2	3	4	5	6	7	8	9	10
11	12	13	14	15	16	17	18	19	20
21	22	23	24	25	26	27	28	29	30
31	32	33	34	35	36	37	38	39	40
41	42	43	44	45	46	47	48	49	50
51	52	53	54	55	56	57	58	59	60
61	62	63	64	65	66	67	68	69	70
71	72	73	74	75	76	77	78	79	80
81	82	83	84	85	86	87	88	89	90
91	92	93	94	95	96	97	98	99	100

Instructors can:

- say a number and ask learners to circle it.
- say a number and ask learners to point to it.

Learners can:

- circle the numbers in their telephone number.
- circle all the same numbers with the same color.
- work in pairs, each having a copy of this page.
Instructors blank out some letters on one sheet and different letters on the other sheet. Pairs read the numbers and fill in the blanks without looking at each other's paper.

1 8 5 3 0 8 1 4 6

5 4 8 9 1 2 0 8 9

7 6 4 1 0 9 7 8 4

9 0 7 4 1 6 2 8 5

1 8 5 3 0 8 1 4 6

5 4 8 9 1 2 0 8 9

7 6 4 1 0 9 7 8 4

0	zero	34	thirty-four	68	sixty-eight
1	one	35	thirty-five	69	sixty-nine
2	two	36	thirty-six	70	seventy
3	three	37	thirty-seven	71	seventy-one
4	four	38	thirty-eight	72	seventy-two
5	five	39	thirty-nine	73	seventy-three
6	six	40	forty	74	seventy-four
7	seven	41	forty-one	75	seventy-five
8	eight	42	forty-two	76	seventy-six
9	nine	43	forty-three	77	seventy-seven
10	ten	44	forty-four	78	seventy-eight
11	eleven	45	forty-five	79	seventy-nine
12	twelve	46	forty-six	80	eighty
13	thirteen	47	forty-seven	81	eighty-one
14	fourteen	48	forty-eight	82	eighty-two
15	fifteen	49	forty-nine	83	eighty-three
16	sixteen	50	fifty	84	eighty-four
17	seventeen	51	fifty-one	85	eighty-five
18	eighteen	52	fifty-two	86	eighty-six
19	nineteen	53	fifty-three	87	eighty-seven
20	twenty	54	fifty-four	88	eighty-eight
21	twenty-one	55	fifty-five	89	eighty-nine
22	twenty-two	56	fifty-six	90	ninety
23	twenty-three	57	fifty-seven	91	ninety-one
24	twenty-four	58	fifty-eight	92	ninety-two
25	twenty-five	59	fifty-nine	93	ninety-three
26	twenty-six	60	sixty	94	ninety-four
27	twenty-seven	61	sixty-one	95	ninety-five
28	twenty-eight	62	sixty-two	96	ninety-six
29	twenty-nine	63	sixty-three	97	ninety-seven
30	thirty	64	sixty-four	98	ninety-eight
31	thirty-one	65	sixty-five	99	ninety-nine
32	thirty-two	66	sixty-six	100	one hundred
33	thirty-three	67	sixty-seven		

Write the numbers.

_____ one
 _____ two
 _____ three
 _____ four
 _____ five
 _____ six
 _____ seven
 _____ eight
 _____ nine
 _____ ten
 _____ eleven
 _____ twelve
 _____ thirteen
 _____ fourteen
 _____ fifteen
 _____ sixteen
 _____ seventeen
 _____ eighteen
 _____ nineteen
 _____ twenty

Write the numbers in words.

1 _____
 2 _____
 3 _____
 4 _____
 5 _____
 6 _____
 7 _____
 8 _____
 9 _____
 10 _____
 11 _____
 12 _____
 13 _____
 14 _____
 15 _____
 16 _____
 17 _____
 18 _____
 19 _____
 20 _____

DATES

What's the date today?



Objective

To introduce days and months.

Goals

- To read calendars.
- To read and write dates in numbers and words.
- To ask and respond to questions regarding days, months and dates.

Suggestions

- Notice the abbreviations for days on appointment cards and calendars (e.g. Sunday, Sun, S).
- It can be helpful but very confusing to teach ordinal numbers. If the learner is ready, try beginning with just 1st, 2nd, and 3rd.
- Calendar dates can be particularly confusing for people following the lunar calendar.
- Learners sometimes don't know their or their children's birth dates. Canadians place much more importance on birthdays than do other cultures. If someone isn't sure of their date of birth upon arrival in Canada, they are usually given a date of birth. Be sensitive to this in your interactions with learners regarding birth dates.
- Learners need to be able to respond both in writing and orally to questions regarding date of birth and arrival in Canada.
- Collect items with dates on them. i.e., 'best before' dates, expiry dates, due dates, late payment dates, stamps, etc.
- Look at flyers to see their effective dates.

Activities

- Write the days on large card or paper. Give one card to each learner. Ask them to line up so the days are in order. Exchange cards and do it again.
- On cards write verbs that learners are familiar with. Ask learners to match the verbs with the days they do those things. Learners can eventually copy the words and create a story about their weekly activities.
- White out the first letter in each day or month, learners write the letter in the blank.
- Have number cards 1-12. Match the months with the number cards.
- Have a year calendar. On a separate paper, write the names of the months. Ask learner to refer to the calendar and write how many days are in each month. You could also do this activity in pairs, giving one learner half of the months and the other learner the other half of the months. They ask each other how many days are in each month.
- Practice "How many" questions (e.g. How many days are in a week? How many days are in a month? How many days are in February? How many days are in a year? How many weeks are in a month? How many weeks are in a year? How many months are in a year?).
- Look at a calendar for this year. Find the dates for various holidays. Give the learner the names of a few holidays and learner writes the date.
- Write the months on a paper. Learners ask each other, "When is your birthday?" Learners write

people's names beside or under the month in which they were born.

- Practice writing dates that are important to the learner such as his birthday, landing date in Canada, children's birthdays, etc.
- Ask learners about important dates in their countries. Ask learners to write these important dates.
- Instructor folds the day or month card to show only the abbreviation. Learner reads the card.



Instructors can:

- say a day and ask learners to point to the day.
- make two copies of this sheet. Cut up one set of days and give them to the learners with a copy of this sheet. Ask learners to match the days.
- cut the day cards in half. Mix them up. Ask learners to put the cards together to make the words.
- show a day and ask learners to read it.

Learners can:

- trace the letters with a pen or marker.
- cut out the days and put them in order.
- copy the days on a separate paper.

Monday
Tuesday
Wednesday
Thursday

Friday
Saturday
Sunday

Instructors can:

- say the day and learners write the missing letters.
- spell the days and learners fill in the missing letters.
- create a similar worksheet with more or less blanked letters.
- create a similar worksheet with variations of spellings for each day.

Learners can:

- read the words on this page.
- copy the missing letters.
- fold the paper and fill in the missing letters.
- copy the days onto the lined paper.
- copy the words on a separate paper.
- cut up the sentences and mix them up. Put the sentences back together.

Monday	__ onday	Mon __ __ __
Tuesday	__ uesday	Tues __ __ __
Wednesday	__ ednesday	Wednes __ __ __
Thursday	__ hursday	Thurs __ __ __
Friday	__ riday	Fri __ __ __
Saturday	__ aturday	Satur __ __ __
Sunday	__ unday	Sun __ __ __

Today is _____.

Tomorrow is _____.

Yesterday was _____.

Instructors can:

- teach the vocabulary on these pages.
- write each verb on a separate card.
- say the verb and ask learners to point to the picture
- say the verb and ask learners to point to the word.
- cut up the pictures. Ask learners to match the verb with the picture.
- say the verb and learners write the verb.
- point to the picture and ask learners to write the word.
- teach the question, "When do you ___?"

Learners can:

- match day cards with verb pictures (e.g., Sunday + walk in the park)
- ask each other questions, "When do you ___?"
- copy the words on a separate paper.

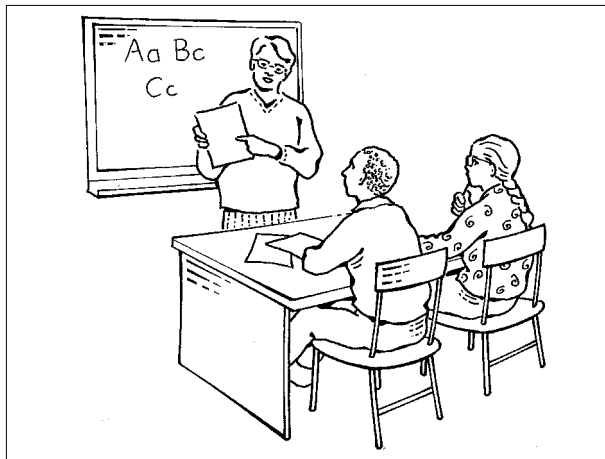

study English

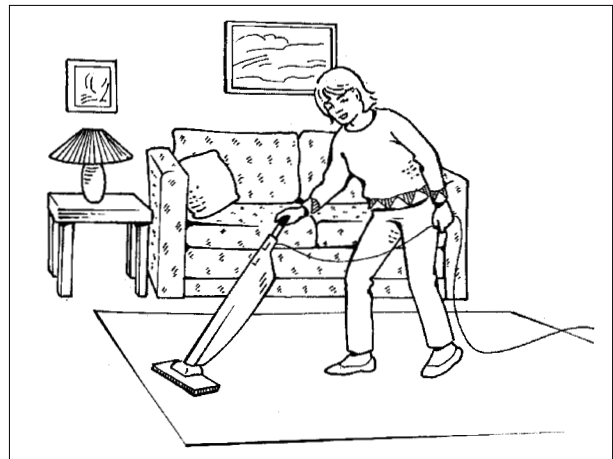

clean



go shopping



visit

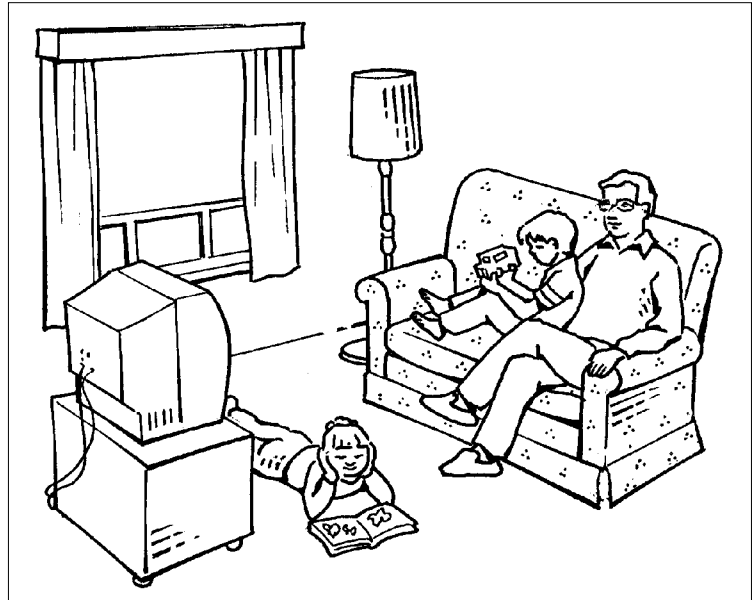

stay home

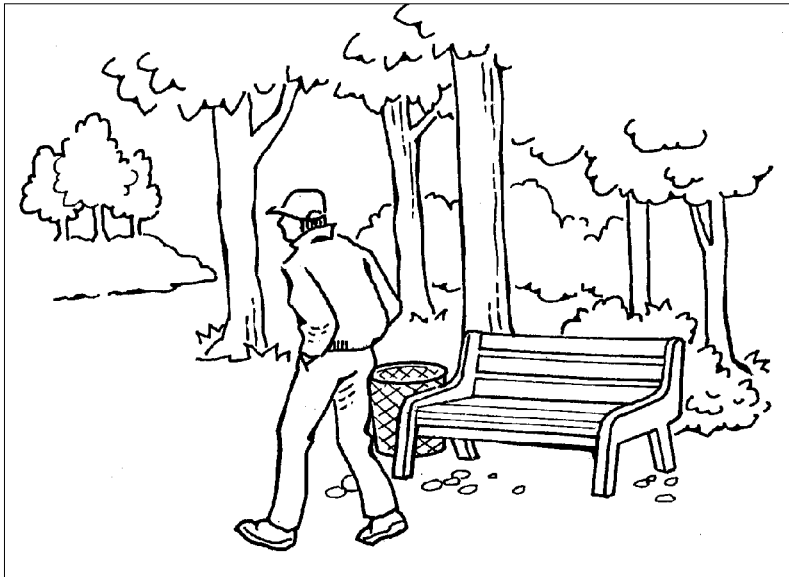

go for a walk



do the laundry

Instructors can:

- teach the questions below.
- read a question and ask learners to point to it.
- write long answers for each learner on individual pieces of paper.
- ask the question and ask learners to point to the day they do this activity.
- ask the question and learners write the day.
- read a question and ask learners to read the same question on this paper.

Learners can:

- read the questions.
- copy the question on the lined paper.
- write the answers on the lined paper.
- write all the answers and create a small story.
- cut up the questions, then put the words back together to form the questions.

When do you go shopping?	When do you do the laundry?	When do you clean your apartment?	When do you visit friends?
When do you walk in the park?	When do you stay home?	When do you study English?	
Monday	Tuesday	Wednesday	Thursday
Friday	Saturday	Sunday	

Instructors can:

- read a sentence and ask learners to point to it.
- show learners a sentence and ask them to point to it.
- show learners a day and ask learners to copy it in the blank.
- show learners two days and ask learners to write the day they do this activity.
- show a picture and ask learners to respond with a sentence, i.e. "I go shopping on Monday."

Learners can:

- read the sentences.
- complete the sentence by writing a day in the blank.
- copy the sentences on a separate paper.
- cut up the sentences. Put the words together.



I go shopping on _____.



I do the laundry on _____.

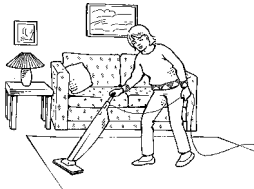

I clean my apartment on _____.

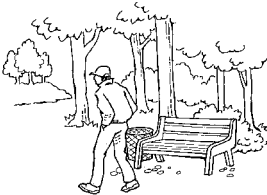

I walk in the park on _____.

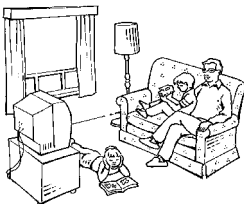

I stay home on _____.





I study English _____.



Instructors can:

- copy this page and give it to learners
- review the question, "When do you ___?"
- review the days of the week.

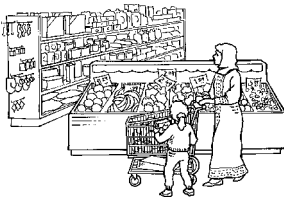
Learners can:

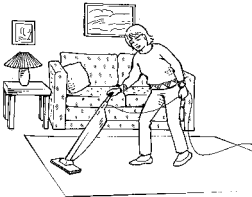
- write classmates' names in the first column.
- ask each other the question, "When do you ___?"
- under the activity and beside their name, write the day that people do these activities.

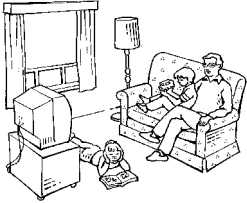
names			

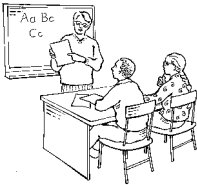
names			

Instructor can:

- make two copies of the months. Cut up two sets of months and ask learners to match the same months.
- say a month and ask learners to point to it.
- show a month and ask learners to read it.
- cut each month in half. Ask learners to put words together.

Learners can:

- trace the letters with a thick marker.
 - cut out the months and put them in order.
 - match names of learners to the month of their birthday.
 - copy the months on a separate paper.
-

January
February
March
April

May

June

July

August

September

October
November
December

Instructors can:

- say the month and learners write the missing letters.
- spell the months and ask learners to fill in the missing letters.
- create a similar worksheet with more or less blanked letters.
- create a similar worksheet with correct and incorrect variations of spellings for each month.

Learners can:

- copy the missing letters.
 - fold the paper and fill in the missing letters.
 - copy the months onto the lined paper at the end of this chapter.
 - cut up the months and numbers and match the numbers to the months.
 - cut up all the months on this page. Match the same words together.
-

- | | | |
|--------------|------------|-------------|
| 1. January | __anuary | Ja__ua__y |
| 2. February | __ebruary | Fe__rua__y |
| 3. March | __arch | Mar__ __ |
| 4. April | __pril | A__ri__ |
| 5. May | __ay | __ay |
| 6. June | __une | __u__e |
| 7. July | __uly | __u__y |
| 8. August | __ugust | Au__us__ |
| 9. September | __eptember | Se__te__ber |
| 10. October | __ctober | Oc__o__er |
| 11. November | __ovember | No__embe__ |
| 12. December | __ecember | Dece__be__ |

Instructors can:

- introduce the names of the seasons.
- look at the pictures and identify the seasons.
- cut out the names of the seasons and ask learners to match the words with the pictures.
- choose one season and identify the vocabulary from that picture.
- write vocabulary on separate pieces of paper.
- ask learners to match the vocabulary with objects in the picture.
- say a season and ask learners to point to it.
- show a season word and ask learners to read it.
- write sentences about the picture and ask learners to read them.
- write sentences with blanked out words and ask learners to fill in the blanks.
- identify the temperature in the season.
- identify other activities that are relevant to that season.
- identify appropriate clothing for each season.

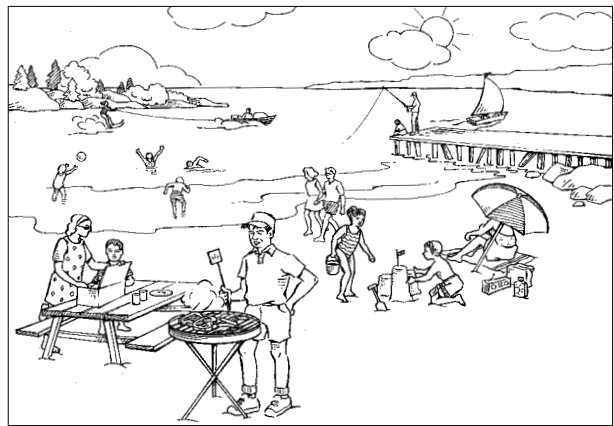
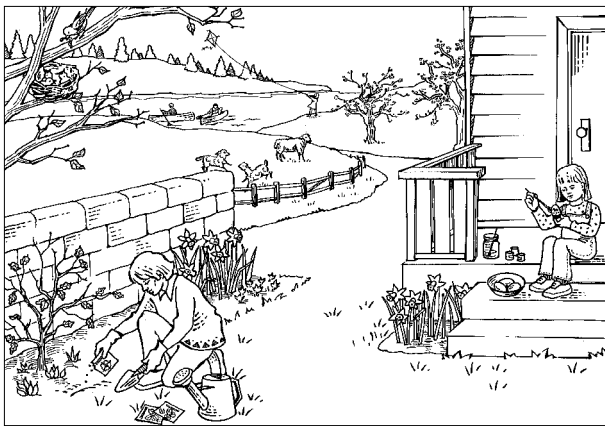

spring

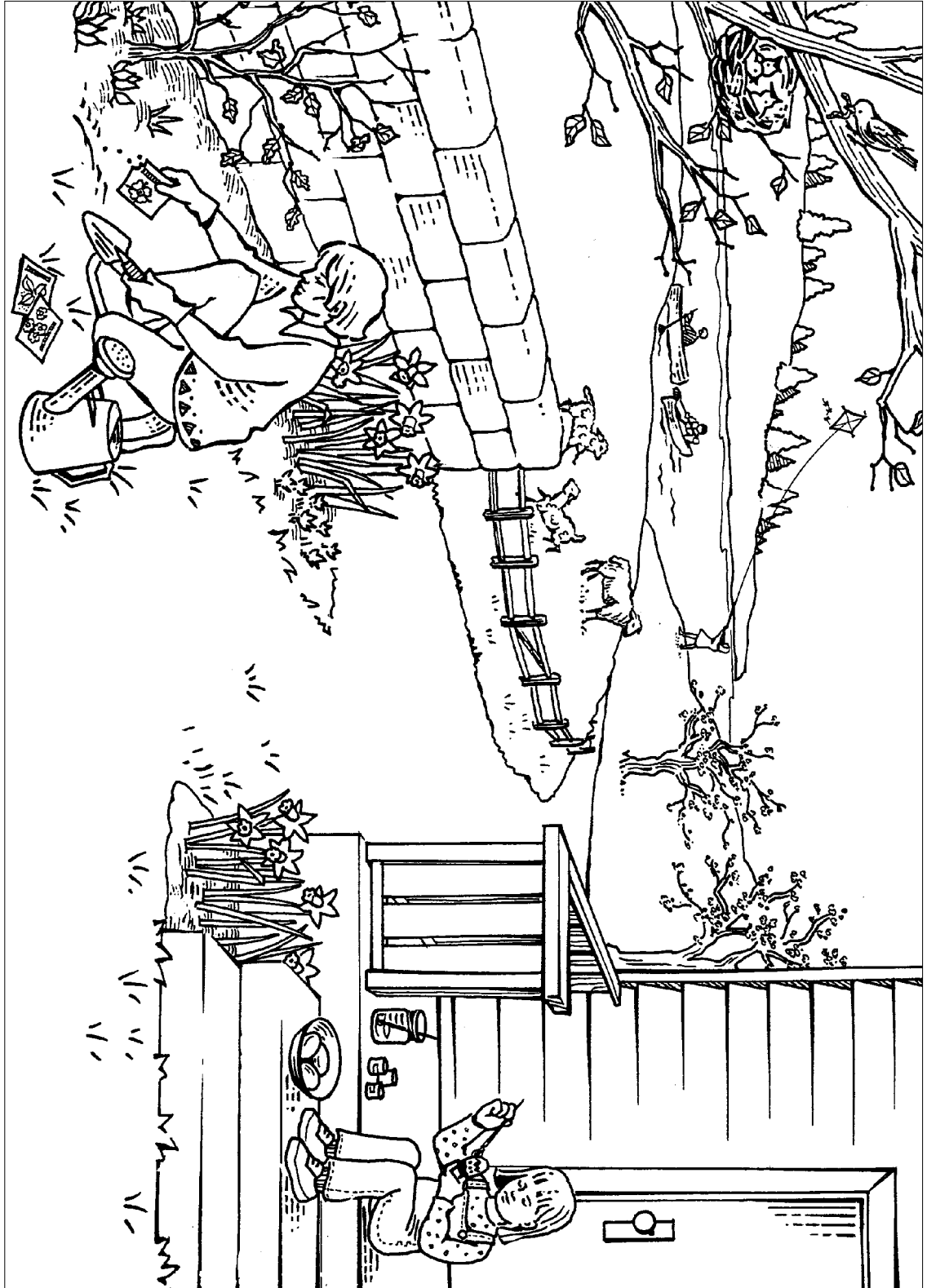



summer

fall



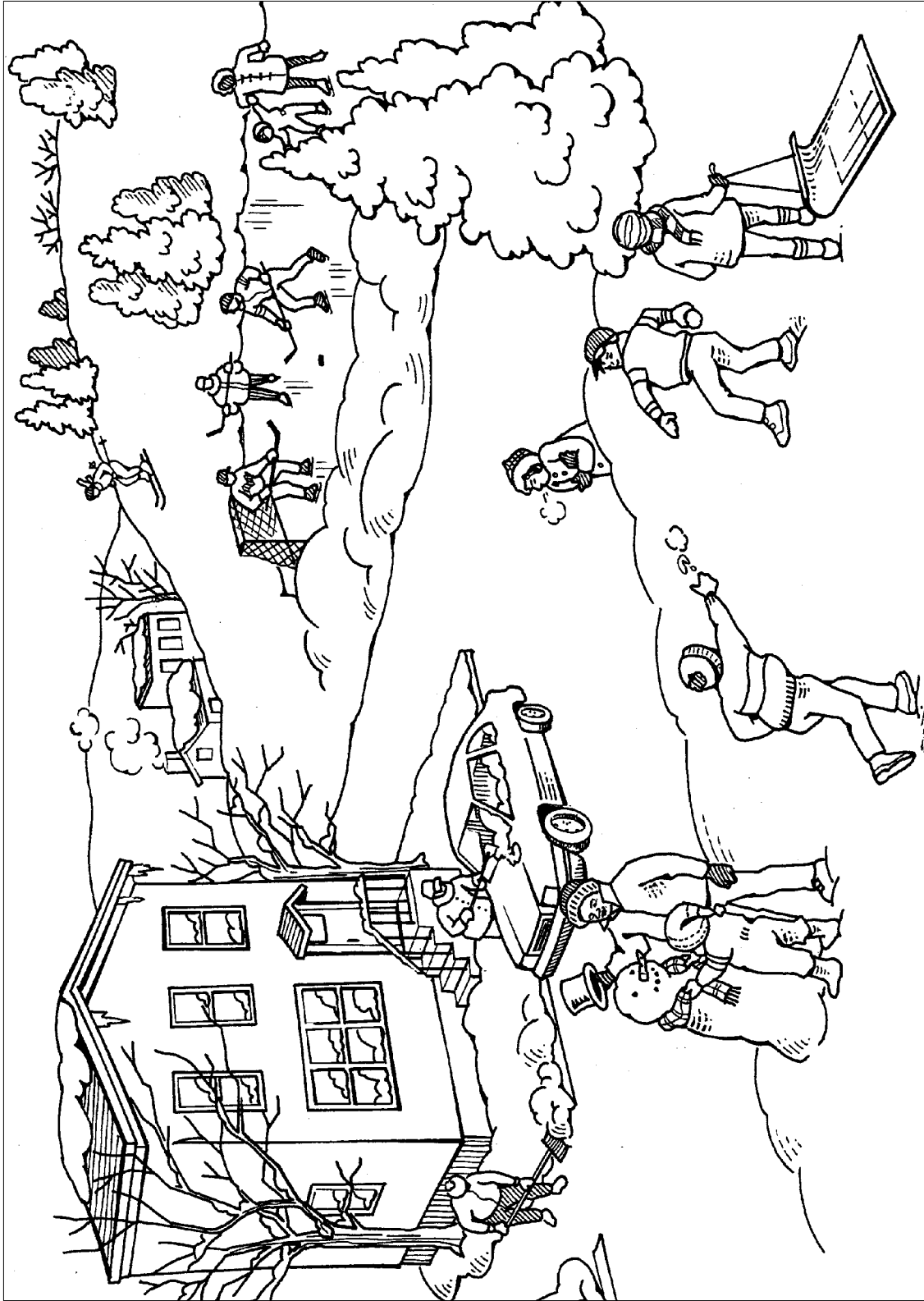

winter

Instructors can:

- show abbreviations of the day and learner points to the full word on the calendar.
- dictate the numbers and ask learners to write them in the boxes.
- say a number and ask learners to say the day (after the numbers are filled in).
- point to a day and ask learners to read it.
- white out some days and ask learners to fill them in.

Learners can:

- trace the numbers on the calendar.
- match a set of number cards with the numbers on the calendar.
- work in pairs. One learner says a date and the other learner circles it.
- read the days as the instructor points to them.
- fill in the missing numbers

Sunday	Monday	Tuesday	Wednesday	Thursday	Friday	Saturday
1	2	3				
8						14
			18			
	23				27	

Instructors can:

- read the sentences and ask learners to fill in the blanks.
- show the word that goes in the blank and ask learners to copy it.
- show two words and ask learners to choose the correct one and write it in the blank.
- cut up and scramble the sentences and ask learners to put the words in order.
- ask learners questions, e.g. "What day is today?" and learners read the answers.

Learners can:

- fill in the blanks.
 - read the sentences.
 - copy the sentences on a separate paper.
-

Today is _____.

Tomorrow is _____.

Yesterday was _____.

This month is _____.

Last month was _____.

Next month is _____.

The date today is _____.

My date of birth is _____.

Instructors can:

- teach the questions below.
- write short answers for each learner on individual pieces of paper.
- write long answers for each learner on individual pieces of paper.
- ask the questions and learners write the answers.
- cut up these questions. Match with answers on the previous page.

Learners can:

- read the questions.
 - match the question with the answer from the previous page.
 - copy the question on the lined paper.
 - copy the answers on the lined paper.
-

What day is today?

What day is tomorrow?

What day was yesterday?

What is this month?

What was last month?

What is next month?

What is the date today?

What is your date of birth?

Sunday

Monday

Tuesday

Wednesday

Thursday

Friday

Saturday

today

tomorrow

yesterday

is

was

study

study English

clean

go shopping

visit

stay home

go for a walk

do the laundry

spring

summer

fall

winter

January

February

March

April

May

June

July

August

September

October

November

December

this

last

month

date

date of birth	next

PERSONAL INFORMATION

What's your name?



Objective

To ask and respond to questions about personal information.

Goals

To ask and respond orally and in writing to personal information questions.

Suggestions

- Ask personal information questions daily.
- Don't teach all the questions at the same time.
- Use local references.
- Use real forms where appropriate but they are often very complicated.
- Repetition is necessary to retain information.
- Create personalized activities that relate to learners.
- Encourage learners to write on the lines from left to right.
- Forms often use abbreviations. Pre-teach the vocabulary and abbreviations before attempting to fill out a form.
- Sometimes trust has to be developed before people feel comfortable sharing personal information.
- People sometimes have received a negative reaction when responding to questions regarding the number of children they have. This can leave learners feeling hesitant when such questions are asked.
- Some forms are written in all upper case letters. Introduce both upper and lower case forms to your learners.

- Many people are cautious about giving out their Social Insurance Number. It is included here because it is a common question for learners. As well, it is important to know what it is and what it is used for. Use your discretion as to how to use it in class.

Activities

- Write learners name several times with various letters blanked out.
- Cut up simple sentences about learner and ask learners to put the papers together.
- Learners ask each other how many children they have, their phone number, their address, etc.
- For more advanced learners, have the questions on one piece of paper and the answers on another piece of paper. Learners match the question with the answer.

Instructors can:

- read the words and ask learners to point to them.
- make student centered worksheets by putting names of family members or addresses in the activity.

Learners can:

- circle the correct spelling.
- copy the correct spelling onto a separate sheet of paper.
- read the words on the left.

name	naem	nmae	name	mane
address	adress	addres	adres	address
street	street	strcet	srteet	stree
number	nmber	number	numbr	numbe
city	cily	cty	ciity	city
province	provnce	province	provinc	
postal code	postl code	posal code	postal code	

Instructors can:

- pre-teach the vocabulary on this page using personal information from the learners.
- say a word and ask learners to point to it.
- say a word and ask learners to say their personal information.
- say a word and ask learners to write their personal information.
- only do one or two questions per day.

Learners can:

- read the words.
 - copy the words onto a separate sheet of paper.
 - write their personal information on another page.
-

name	last name	country	city
apartment number	date of birth	children	telephone number
address	postal code	social insurance number	street

Instructors can:

- show words that can go in the blanks and ask learners to write them.
- read the words and ask learners to write in the information.
- provide learners with personal information on separate pieces of paper. Ask learners copy the information in the blanks.

Learners can:

- read the words.
 - copy the words in the blanks.
 - write their personal information in the blanks.
 - cut up this page and match the words.
-

first name _____

last name _____

street _____

city _____

province _____

postal code _____

address _____

telephone number _____

date of birth _____

country _____

social insurance number _____

Instructors can:

- show a word and ask learners to circle it.
- say a word and ask learners to circle it.
- ask learners how to spell the words.
- make two copies of this activity and cut one up.
Ask learners to put the cut-up words on this paper with the same words.
- spell a word and learners circle it.
- explain the use of capital letters for names and places.
- create a similar worksheet substituting words that are more meaningful to learners.

Learners can:

- circle the same words.
- copy the words on a separate paper.
- read the words.
- spell the words to each other.

Plateau	Glenforest	Plateau	Spring Garden
Halifax	Canada	Dartmouth	Halifax
Nova Scotia	Truro	Nova Scotia	Bedford
name	street	name	address
number	name	number	Nova Scotia
Barrington	Brunswick	Gottingen	Barrington

Instructors can:

- dictate the words.
- show a word and ask learners to copy the word in the blank.
- review asking and responding to the question, "How do you spell ___?"

Learners can:

- copy the words in the blanks.
- work in pairs. Fold the paper in half. Learners read the words to their partners. Partners write the words and ask for help with spelling if necessary.

1. Halifax

1. _____

2. _____

2. 457-9894

3. number

3. _____

4. _____

4. name

5. children

5. _____

6. _____

6. address

7. Nova Scotia

7. _____

8. _____

8. apartment

9. city

9. _____

10. _____

10. telephone

Instructors can:

- show learners their last name, postal code, phone number, etc. and learners copy it in the appropriate place.
- fill in the form with personal information from the learners. Ask learners to copy the information onto the same blank form.

Learners can:

- fill out these forms.
- work in pairs. One learner fills in the form with the information from her partner.
- refer to page 4.3 for help with spelling.

_____	_____
First	Last

Address	
_ _ _ - _ _ _ _	
Telephone	

Name	_____		
Address	_____		
City	_____	Province	_____
Postal code	_____		
Phone number	_____		
Date of birth	_____		
Social Insurance Number (SIN)	_____		

Instructors can:

- write the important words (name, live, address, postal code, telephone number) and ask learners to match the words with the pictures.
- say the sentences and ask learners to put them in order.
- hold up a picture and ask learners to hold up the sentence that goes with the picture.

Learners can:

- talk about the pictures.
- read the sentences.
- copy the sentences on a separate piece of paper.
- match the sentence with the picture.
- write the sentences and substitute their own information.
- cut up the sentences and put them in order.



This is Rada.



She is from Croatia.



Her telephone number is 445-1028.



Her address is 59 Glenforest Drive.

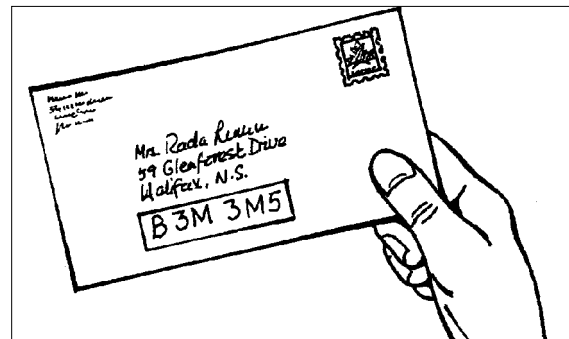

Her postal code is B3M 3M5.

Instructors can:

- show the word that goes in the blank and ask learners to copy it.
- show two words and ask learners to choose the correct one and write it in the blank.
- read the sentences and ask learners to fill in the blanks.
- ask learners questions, e.g. "What is your name?" and learners read the answers.
- cut up a sentence into individual words. Mix them up and ask learners to put the words in order.
- repeat these activities frequently.

Learners can:

- fill in the blanks.
 - copy the sentences on a separate paper.
 - work in pairs and read the sentences to each other.
-

My name is _____	I am from _____	My address is _____
My apartment number is _____	My postal code is _____	My telephone number is _____
My date of birth is _____	My Social Insurance Number is _____	I have _____ children

Instructors can:

- teach the questions below.
- say a question and ask learners to point to it.
- write short answers for each learner on individual pieces of paper.
- cut up the previous page or write long answers for each learner on individual pieces of paper.
- say the question and ask learners to point to the answer.
- ask the question and learners write the answer.

Learners can:

- read the questions.
- copy the question on the lined paper.
- copy the answers on the lined paper.
- cut up the previous page and match the question with the answer.
- write all the answers and create a small biography.

What is your name?	Where are you from?	What is your address?
What is your apartment number?	What is your postal code?	What is your telephone number?
When is your date of birth?	What is your social insurance number?	How many children do you have?

Circle and Find

s o c i a l i n s u r a n c e n u m b e r
 y x s s c y a t x w a x v z b f n i k k t
 k s o a n m f k k b j b r q h a l i f a x
 a l c n c n a m e o p z j w b e v c d g b
 w q a h g m n p v p r o v i n c e f e o f
 w k l t e l e p h o n e n u m b r r n p q
 a t i u j k b q b a y f d c l v y o z u q
 d c n s j v s n a p a r t m e n t m k l f
 d i s t n f t p o s t a l c o d e f x a b
 r t u s u i m m v x b c k k n d a a f s t
 e y r a m r z q b i r t h d a y c j g n b
 s a a o b s x r t s a a s t z n h c g n b
 s e w v e t k o u w h l p b v o i s z a s
 w t c g r n m o o f h b w q f v l d w m t
 d i e a o a q s w k p v z y a a d u m e r
 e u n p o m d n s y k f b g g s r a r z e
 z y u l d e y b s b j e p w z c e d l h e
 C a n a d a N o v a S c o t i a n o n e t

address
 apartment
 birthday
 children
 city
 first name

from
 Halifax
 last name
 name
 Nova Scotia
 number

postal code
 province
 social insurance number
 street
 telephone
 Canada

name

address

street

number

city

province

postal code

telephone

last

first

apartment

Canada

children

country

Social
Insurance
Number

Nova Scotia

date of birth	



MONEY

How much is it?

Objective

To introduce money and prices.

Goals

- To recognize Canadian coins and their values.
- To request information about money and prices.
- To respond to questions about money and prices.
- To introduce basic numeracy concepts.

Suggestions

- When possible, use real coins and bills. Plastic Canadian money is available at educational resource stores.
- Flyers are a good source for practicing reading prices.
- It is important for learners to feel comfortable with numbers 1-100 before learning prices.
- Collect the price tags from articles you buy.
- Go to a store and practice reading prices.
- Money stamps and money Bingo are available at educational resource stores.
- When practicing to count and add, it is useful to use the 1-100 number paper on page 2.7
- Introduce learners to the different ways to write prices (\$.05, 5¢)

Activities

- Have a variety of coins. Ask learners to match 10 pennies with a dime, two nickels with a dime, two dimes and a nickel with a quarter, etc.
- Instructors say a price and ask learners to write it. Increase difficulty as learner is ready.
- Have combinations of real coins or pictures of coins and ask learners to write the total values.
- Pre-teach is/are. Practice asking and responding to the question "How much is/are ___?" using real items belonging to the learners.
- Collect a variety of price tags. Say a price and learners choose the correct one. Discussion can follow as to possibilities of what item the tag came from.
- Make a prices Bingo. Copy the blank Bingo card from this kit and write prices in the blanks.
- Make money Bingo. Copy the blank Bingo card from this kit and put pictures or stamp of coins in the blanks.
- Role-play buying items and practice giving change.
- Practice giving change. Learner has \$10 bill and buys something from the flyer; another learner gives the appropriate change.

Instructors can:

- read a word and ask learners to point to it.
- provide real coins and ask learners to match the coins with the pictures.
- white-out several letters and ask learners to fill in the blanks.

Learners can:

- put the coin in the box.
- cut up this page and then match the picture, word, value, and the real coins.



penny
.01 or 1¢



nickel
.05 or 5¢



dime
.10 or 10¢



quarter
.25 or 25¢



loonie
\$1.00



toonie
\$2.00

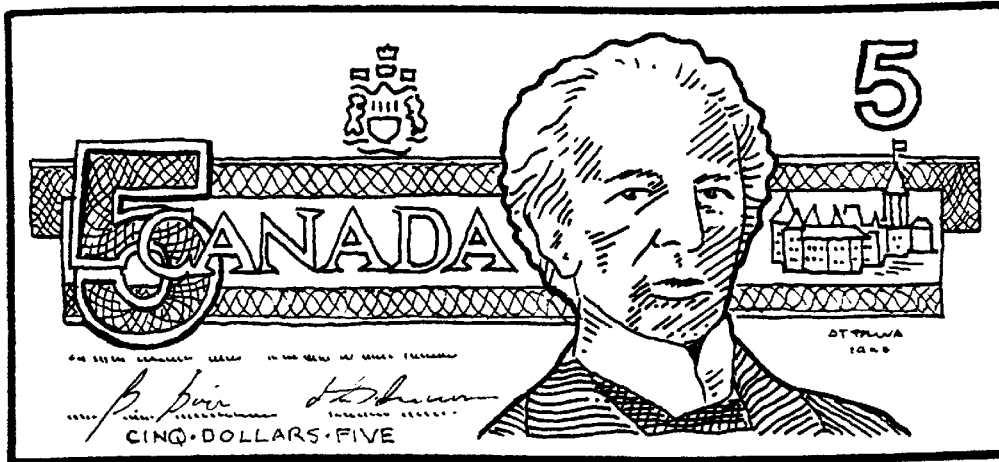

\$5.00 bill



\$10.00 bill

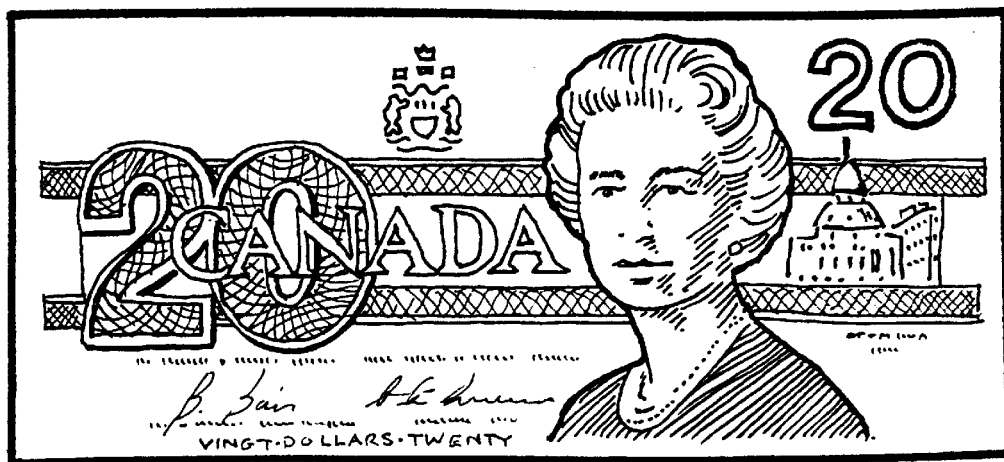

\$20.00 bill

Instructors can:

- review the names of the coins.
- say the name of one coin and ask learners to circle its value.
- say the value of a coin and ask learners to point to it.
- show a coin and ask learners to point to its value.

Learners can:

- look at the picture and circle its value.
- write the names of the coins in the blanks.
- have several real coins and place them on the words that represent their values (e.g. put a dime on .10).
- after placing real coins on the values, add the total value of the coins and write it in the blanks.



.10

.05

.25



\$1.00

\$2.00

.01



\$1.00

\$2.00

.25



.25

.05

.10



.01

\$2.00

.10



.01

\$1.00

.05

Instructors can:

- say an amount and ask learner to circle it.
- show learners a written amount and ask learners to circle the same amount..

Learners can:

- match coins with the values on the paper.
 - circle the smallest amount.
 - circle the largest amount.
-

.05	.10	.25	.15
.25	.35	.75	.50
.40	.20	.60	.30
.75	.45	.95	.65

\$10	\$30	\$50	\$60
\$11	\$2	\$8	\$5
\$17	\$13	\$15	\$19
\$55	\$50	\$20	\$15

\$10.25	\$22.25	\$2.25	\$5.25
\$15.20	\$13.10	\$17.50	\$19.70
\$55.95	\$15.55	\$20.65	\$50.75
\$37.17	\$98.97	\$75.57	\$49.27

Instructors can:

- say the name of one coin and ask learners to circle it.
- say the value of a coin and ask learners to point to the picture.
- show a coin and ask learners to point to the picture.
- write the value of a coin on a sheet of paper and ask learners to point to the coin.
- say the value of a coin and ask learners to point to the word.

Learners can:

- look at the picture and circle the name of the coin.
- write the names of the coin in the blank.
- put a real coin in the blank.
- write the value of the coins in the blank.



penny

nickel

dime



dime

loonie

quarter



toonie

penny

nickel



quarter

toonie

loonie



penny

quarter

dime



penny

nickel

dime

Instructors can:

- say an amount and ask learners to point to it.
- say an amount and ask learners to circle it.
- use real coins in place of the illustrations on this page.

Learners can:

- draw a line from the left column to the matching value in the right column.
- write the total amounts beside the illustrations.
- work in pairs. Cut the paper down the middle. Each partner takes half the sheet. Each learner cuts up her paper. Learners take turns asking each other for the amount on each piece of paper. (e.g. Learner A has two nickels. He asks his partner, “Do you have ten cents?” Learner B gives her partner the picture of a dime.)

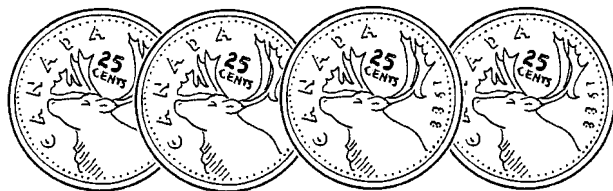
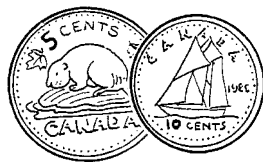
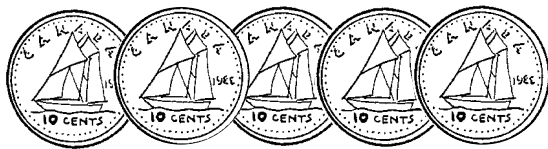
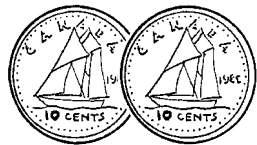
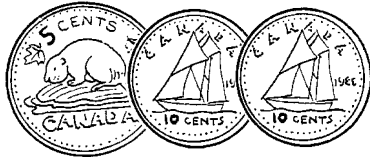





Instructors can:







- pre-teach - (minus) and = (equals)
- say the total and learners write it.
- say the names of the coins and ask learners to write the words.
- change the plus signs to minus (where appropriate) and teach subtraction skills.



Learners can:



- add the coins and write the total value.
- write the names of the coins.
- write the values of the coins.
- match real coins with the illustrations.
- match real coins with the illustrations and write the total amount.
- explore different combinations of coins to equal the same total.



 +
  = _____

 +
 
 = _____

 +
 



 = _____

 +
  = _____

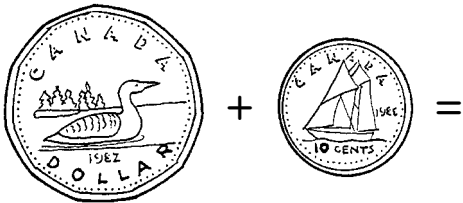
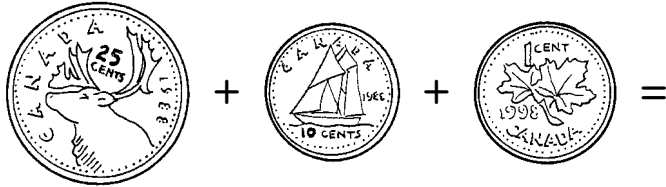
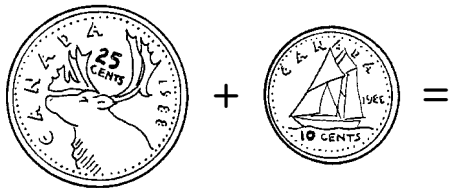
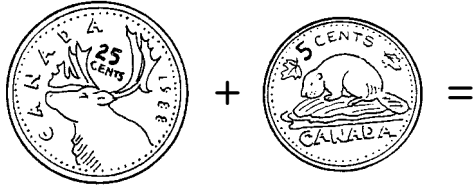
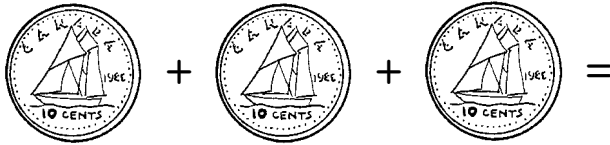
 +
  = _____

 +
  +
  = _____







Instructors can:

- introduce the vocabulary on this page.
- hold up a picture and ask learners to say the word.
- hold up the word from this page and ask learners to read it.
- hold up the price and ask learners to read it.
- cut up the pictures and the words and ask learners to match them.
- introduce the question, "How much is the ___?"

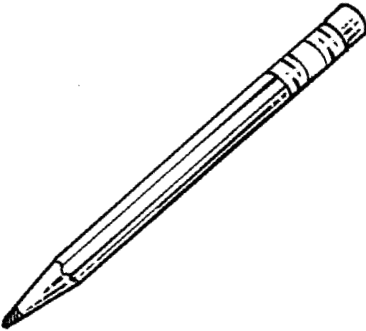
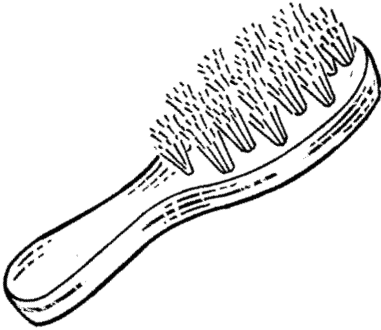
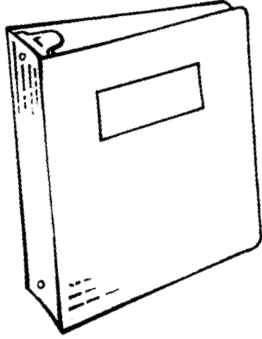
Learners can:

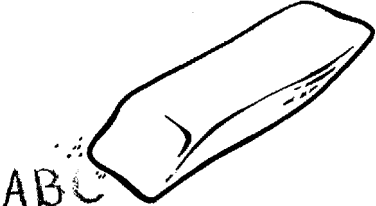
- copy the words on a separate paper.
- copy the prices on a separate paper.
- work in pairs and ask each other, "How much is the ___?"
- look in current flyers for these words. Compare the price.

 <p>pencil .25</p>	 <p>brush \$4.99</p>
 <p>binder \$7.78</p>	 <p>watch \$32.50</p>
 <p>eraser \$3.00</p>	 <p>kettle \$37.29</p>

Instructors can:

- pre-teach the questions: "How much is ___?"
- ask learners to work in pairs. From the previous page, give three words with prices to one learner. Give the other three words and prices to the other learner. Learners ask each other the question "How much is the ___?" and write the prices in the blanks.

Learners can:

- from the previous page copy the prices in the blanks.
- cut up the words from the previous page and match the words to the pictures on this page.
- look in current flyers and write the price of the items on the page.

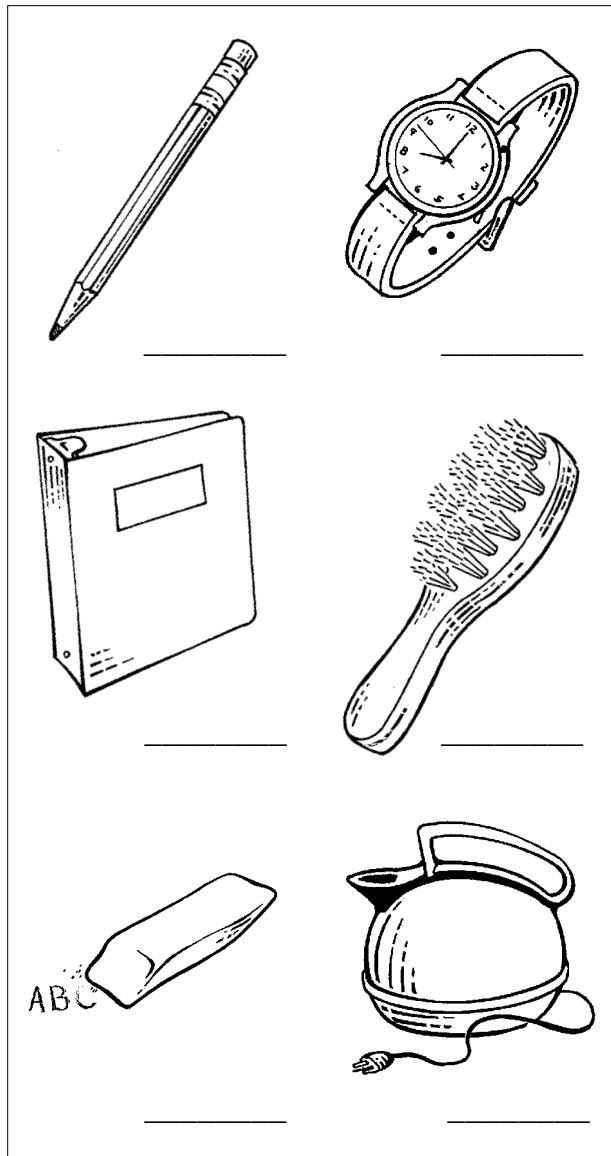
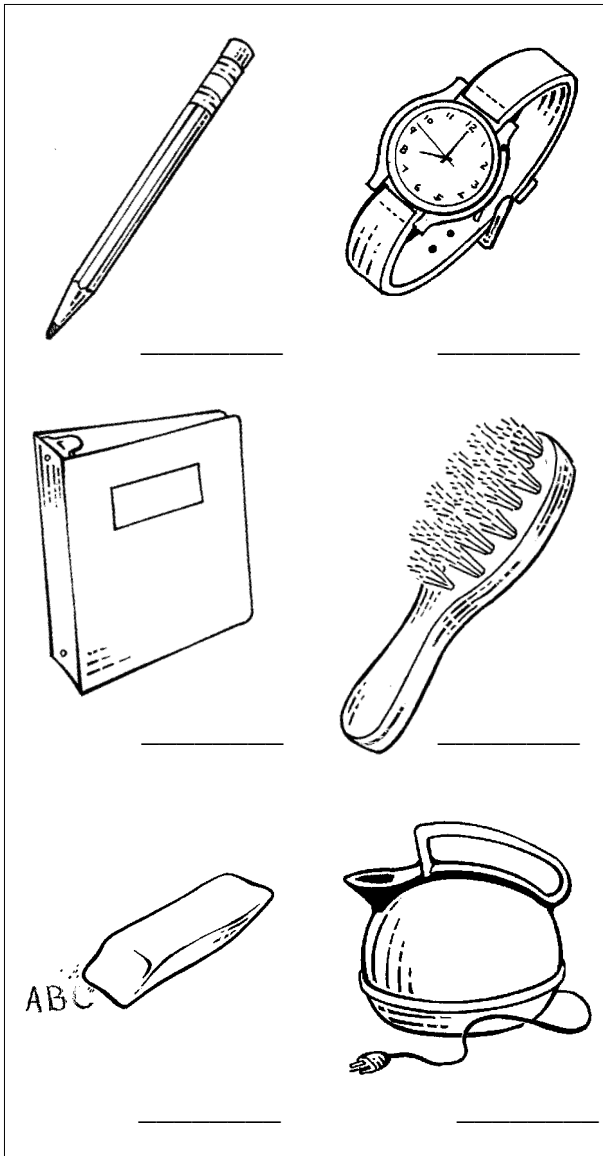

Do you have change?

1. Identify and teach key vocabulary from the picture (bus, change, \$5, etc.).
2. Write vocabulary from the illustration on separate pieces of paper and ask learners to match the words with the picture.
3. Show a word from the illustration and ask learners to point to it.
4. Look at the picture and ask learners to identify what is happening.
5. Instructor writes what the learners say in sentences.
6. Instructor reads the sentences.
7. Learners read the sentences.
8. Instructor whites out a word from each sentence and asks learners to fill in the blank.
9. Instructor cuts up one sentence and mixes the words up. Learners put the words in order to remake the sentence.
10. Cut up the story into sentences and put them in order.
11. Learners can copy the sentences onto a separate paper.



Instructors can:

- say an amount and ask learners to point to it. show coins and ask learners to point to the amount on the paper.
- give learners a variety of coins. Show them a written amount and ask them to give you the same amount in coins.
- give learners a page of picture coins and this page. Cut them up and ask learners to match them.
- make two copies of this page. White out some amounts from one copy and different amounts from the other copy. Ask learners to work in pairs. Learners read the amounts together starting at 5 cents, 8 cents, etc., reading the amounts to each other. When there is a blank, one learner says the amount and the other writes it in the blank.

Learners can:

- have a variety of coins and place the correct amount of coins on the written numbers.
- cut up this page and put the amounts in order from smallest to biggest amounts.
- copy the amounts to a separate piece of paper.

5¢	8¢	10¢	15¢	18¢	20¢
25¢	30¢	35¢	38¢	45¢	47¢
50¢	51¢	54¢	61¢	65¢	70¢
76¢	83¢	85¢	90¢	92¢	95¢
\$1.00	\$1.15	\$1.25	\$1.55	\$2.00	\$2.05
\$2.10	\$2.25	\$2.48	\$2.65	\$2.75	\$3.00



penny

nickel

dime

quarter

loonie

toonie

TIME

What time is it?



Objective

- To introduce time.

Goals

- To read regular and digital clocks.
- Ask and respond to questions regarding time.

Suggestions

- Buy a big clock or use an old one.
- Learners need to know numbers 1-60 before learning to read the time.
- Use items that are useful to the learner (bus schedules, TV guide, school times, store opening times, doctor hours.)
- Show learners the different numbers on clocks (digital, regular, Roman numerals, no numbers).
- For more advanced learners, you might want to introduce the concept of a.m. and p.m.
- Review time everyday.
- Teach daily activity verbs to allow learners to talk and write about daily activities and at what time they participate in these activities.
- Allow learners to change the clock when practicing.
- Look at stores or offices open hour signs.
- Teach one way of telling time thoroughly before attempting the other way (quarter to three or two forty-five).
- Time flash cards are readily available at educational supply stores.
- A clock face stamp is also available that makes producing your own worksheets much easier.

Activities

- Instructor or another learner shows a clock. Learner says the time.
- Two clocks are needed. Instructor or another learner shows a clock. Learner sets her clock to the same time.
- Create your own Bingo game.

Board Game:

- Lay out the time board game found in the front pocket of the binder. You need dice and all players need something to move around the board. You also need a clock. Determine who begins first. That person rolls the dice. If he lands on a clock, someone asks him, "What time is it?" The first player reads the time. Then he can ask others, "What do you do at 4:00?" If a player lands on a picture of a verb, the player says the verb. Then the player asks others, "What time do you ___?" Then the player takes the clock and arranges the hands on the clock to represent the time she does the activity. This activity provides opportunities for learners to practice asking and reading the time as well as talking about daily activities.

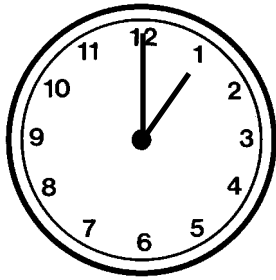

1:00

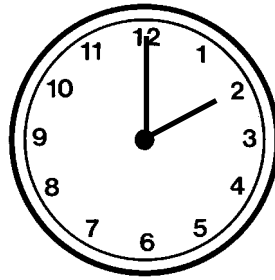

2:00

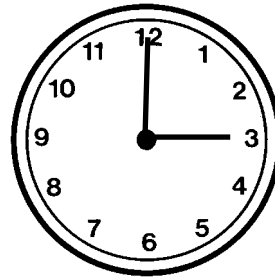

3:00

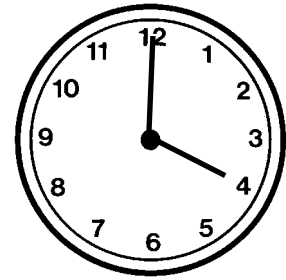

4:00

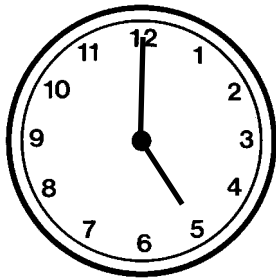

5:00

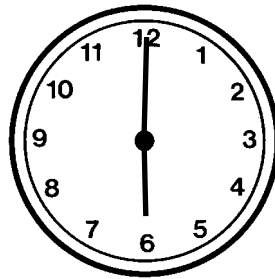

6:00

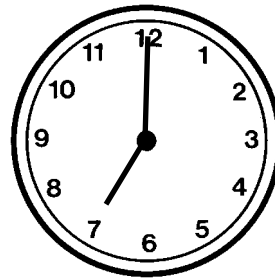

7:00

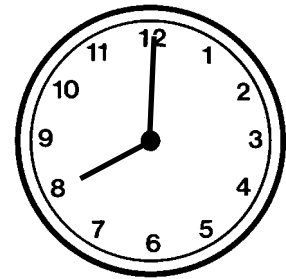

8:00

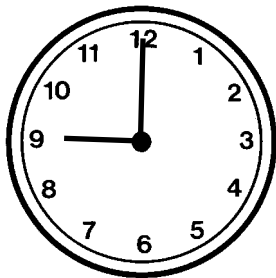

9:00

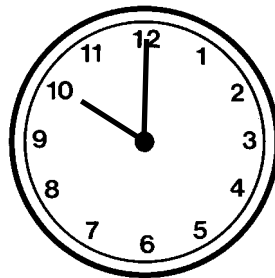

10:00

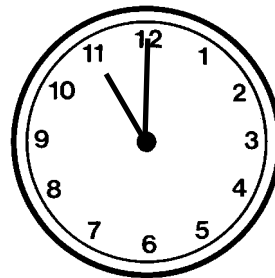

11:00

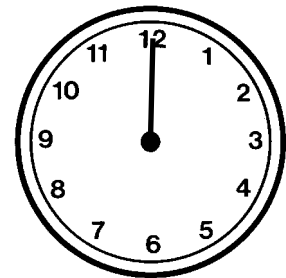

12:00

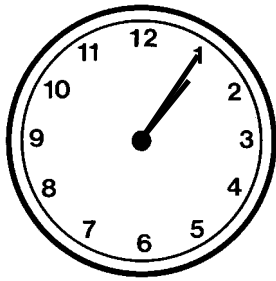

1:05

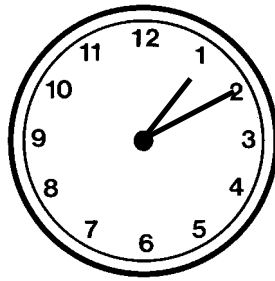

1:10

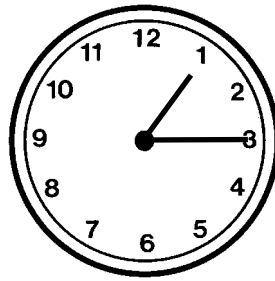

1:15

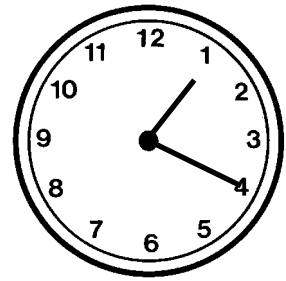

1:20

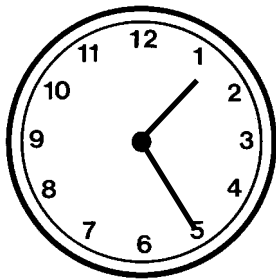

1:25

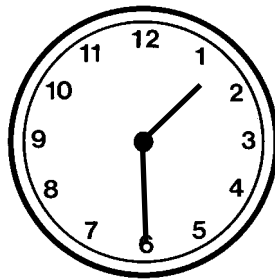

1:30

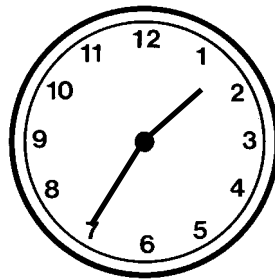

1:35

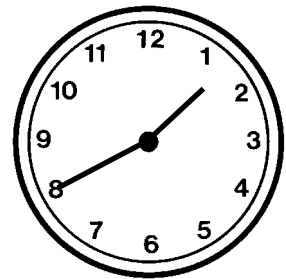

1:40

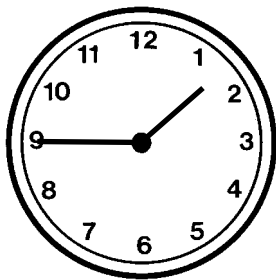

1:45

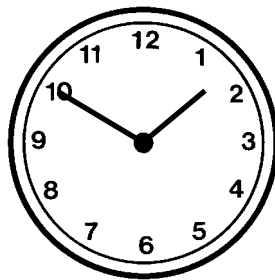

1:50

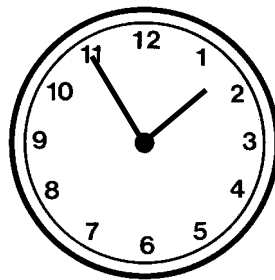

1:55

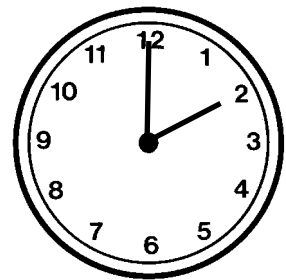

2:00

Instructors can:

- say the time and ask learners to write the time.
- copy and cut up the times on the next page. Show the time and ask learners to write the time under the clock indicating the same time.
- copy the next page of times, cut it up and ask learners to match the clocks with the times.

Learners can:

- write the time.
- read the time.
- work in pairs. Point to a clock on this page and ask your partner, "What time is it?" The partner says the time.
- work in pairs. Point to a clock on this page and ask your partner, "What time is it?" The partner has a copy of the next page and points to the same time as was said.

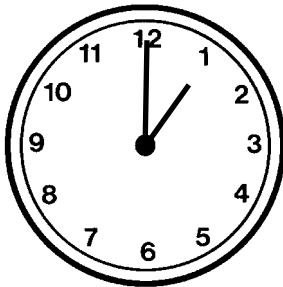

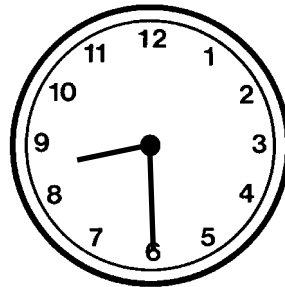

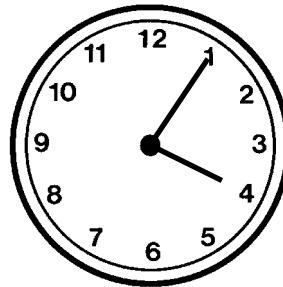

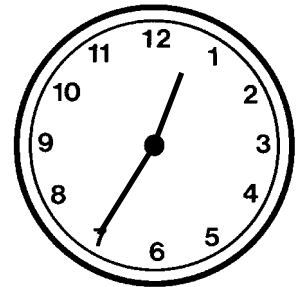

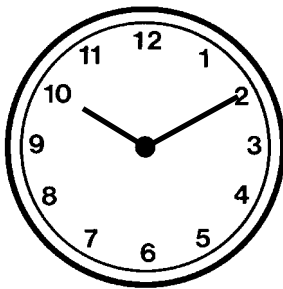

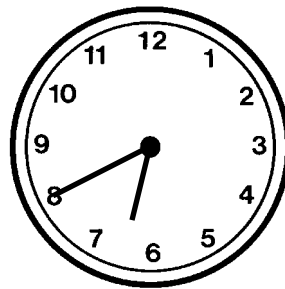

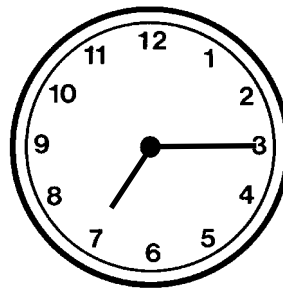

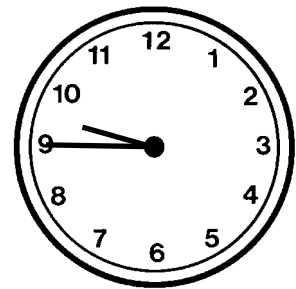

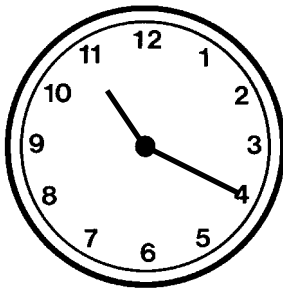

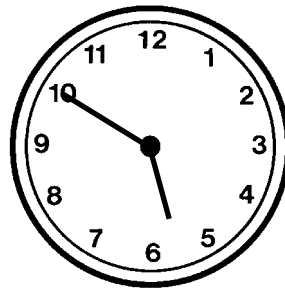

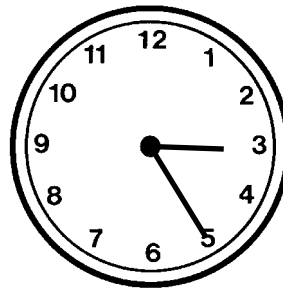

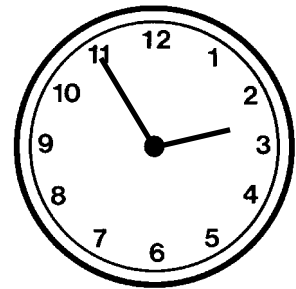

1:00

8:30

4:05

12:35

10:10

6:40

7:15

9:45

11:20

5:50

3:25

2:55

Instructors can:

- ask learners to cover the pictures of the clocks on this page. Show a clock set to a time below and ask learners to circle the same time.
- say a time listed below and ask learners to write it.
- say a time and learners write it and say what they do at that time each day.
- create similar worksheets with more variety of times shown.
- cut up the clocks. Say a time and ask learners to select the correct clock.

Learners can:

- circle the correct time as illustrated in the clock pictures.
- have a clock and set the clock to the times listed below.
- work in pairs. Each partner takes turns saying a time and her partner points to it.



2:00

1:00

1:05

12:00



6:15

6:00

3:30

3:45



7:45

9:30

7:15

7:00



3:00

2:00

12:15

3:30



12:30

6:00

12:00

6:30



5:45

9:30

6:45

10:30



2:00

3:45

2:15

2:45



5:00

4:00

12:15

12:30

What time do you _____ ?

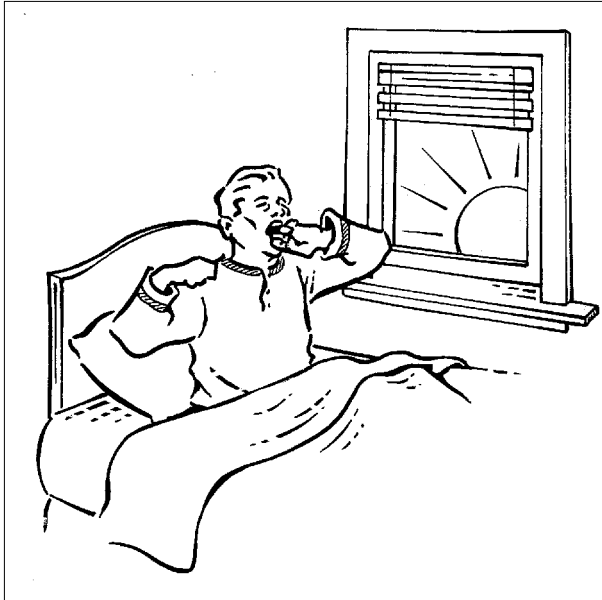

get up



eat breakfast

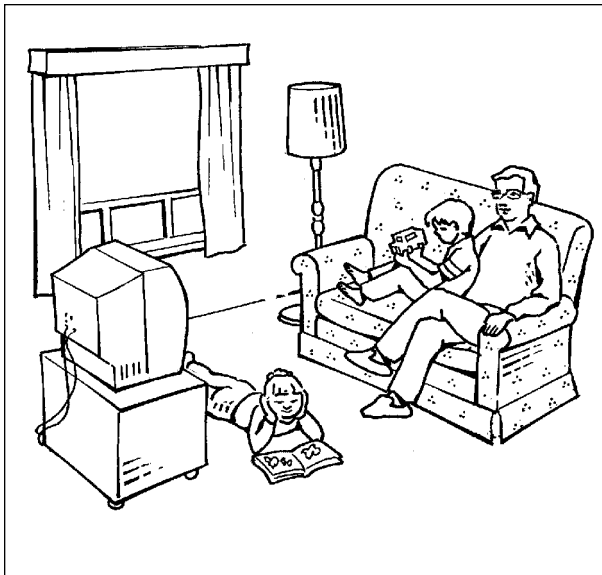

watch TV

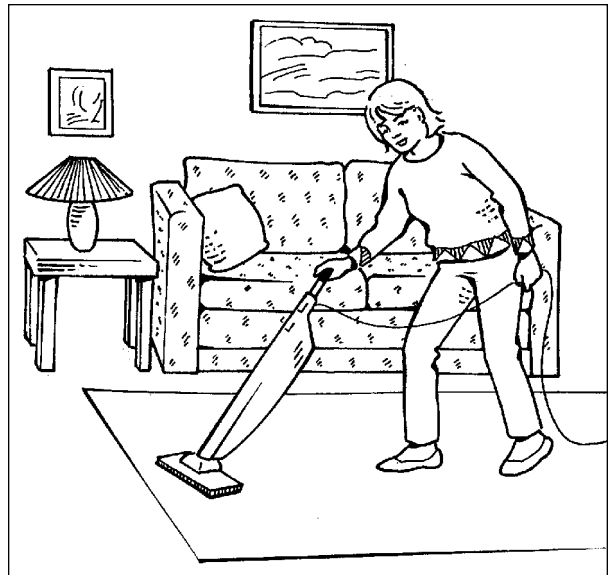

clean

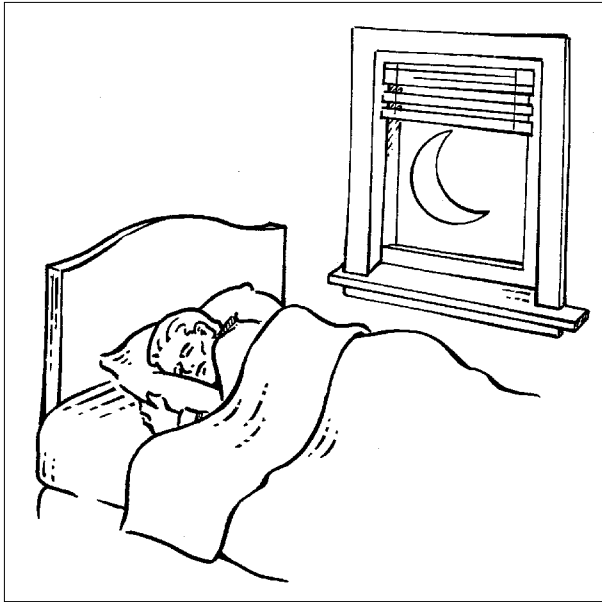

go to bed

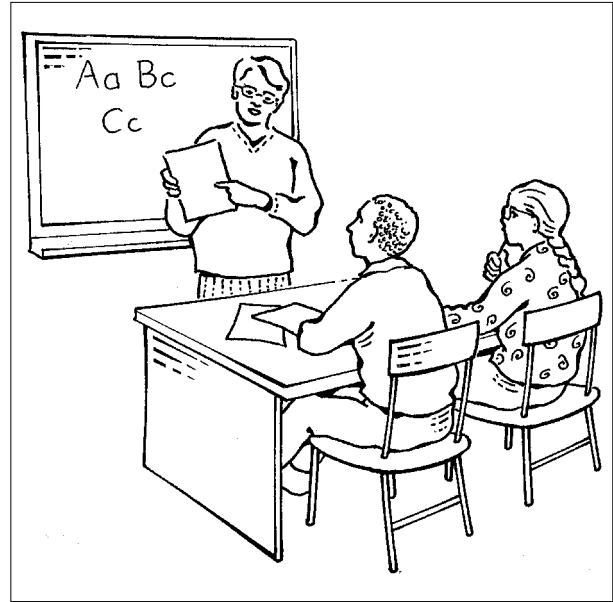

study English



take a shower

Instructors can:

- say a time and ask learners to write the time.

Learners can:

- look at the picture and read the sentence.
 - fill in the blanks with a time.
 - cut up the pictures and the sentences and match them.
 - copy the sentences on to a separate sheet of paper.
 - change the "I" to another member of the family or a classmate.
 - work in pairs. Ask your partner, "What time do you ___?" Write the times in the blanks.
-

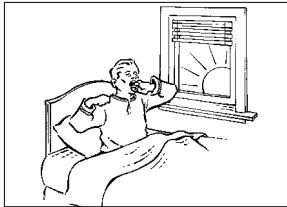

I get up at _____.



I take a shower at _____.



I clean at _____.

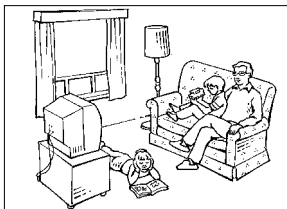

I watch tv at _____.

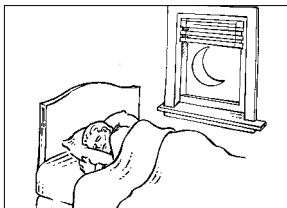

I go to bed at _____.

Instructors can:

- pre-teach the question, “What time does (place) open on (day) ?”
- ask learners questions regarding store hours.
- make two copies of this page. White out some of the times on one copy and different times on the other copy. Ask learners to ask each other, “What time — ” and fill in the blanks.

Learners can:

- read the store hours.

**Sobeys store hours**

7:00 am Monday to
12:00 midnight Saturday

**ROYAL BANK****Royal Bank hours**

	Open	Close
Monday	9:30	5:00
Tuesday	9:30	5:00
Wednesday	9:30	5:00
Thursday	9:30	5:00
Friday	9:30	5:00
Saturday	closed	
Sunday	closed	

**Zellers store hours**

	Open	Close
Monday	9:00	9:30
Tuesday	9:00	9:30
Wednesday	9:00	9:30
Thursday	9:00	9:30
Friday	9:00	9:30
Saturday	9:00	9:00
Sunday	closed	

get up

go to bed

watch TV

clean

study English

take a shower

WEATHER

What's the weather today?

Objective

To be able to identify weather conditions.

Goal

To ask and respond to questions about weather.

Suggestions

- Newspapers are a useful resource as they usually have good illustrations of weather.
- Weather is a popular topic for small talk. It is good for learners to be able to respond to small talk regarding weather.
- Walking on snow and ice is a challenging task. Tell your learners to use extra caution when walking in snow and on ice.
- Footwear is also important in winter. Ensure that your learners understand the importance of both the tread on boots and shoes as well as the warmth.
- The weather in Nova Scotia is very changeable. This is useful for learners to be aware of so they can dress accordingly.
- Clothing vocabulary can be taught along with weather.
- It is a skill to be able to keep warm in the winter. Learners from warmer climates may not have had the opportunity to develop this skill, so it is an important for the instructor to pass this information along.

- Driving in winter conditions is tricky for all of us. Black ice, freezing rain, snow tires, jumper cables are all very important words to know. Winter driving is not included here but it would be useful for instructors to develop materials around this topic area.
- Along with winter weather comes school cancellations. Ensure that learners know what to listen for on the radio regarding school cancellations. In Halifax the announcement is, "All schools in the Halifax Regional School Board are closed." Because of the bus system in the rural areas of the Halifax Regional Municipality, school officials still refer to Halifax County.

Activities

- Video a weather report from TV. Give learners written weather words on cards. Play the video and ask learners to put the words in order as they hear them.
- Write the weather words on separate cards or pieces of paper. Have the weather report from the newspaper. Ask learners to match the word with the picture.
- Review the weather every day. Weather vocabulary is best taught when the same weather conditions are present. For example, it is very difficult to describe "foggy". If it is taught on a foggy day, and

reviewed on foggy days, it will be easier and more successful for everyone.

In a snow storm:

- Stores sometimes close.
- School is sometimes cancelled.
- People drive very slow.
- You can't park your car on the street.

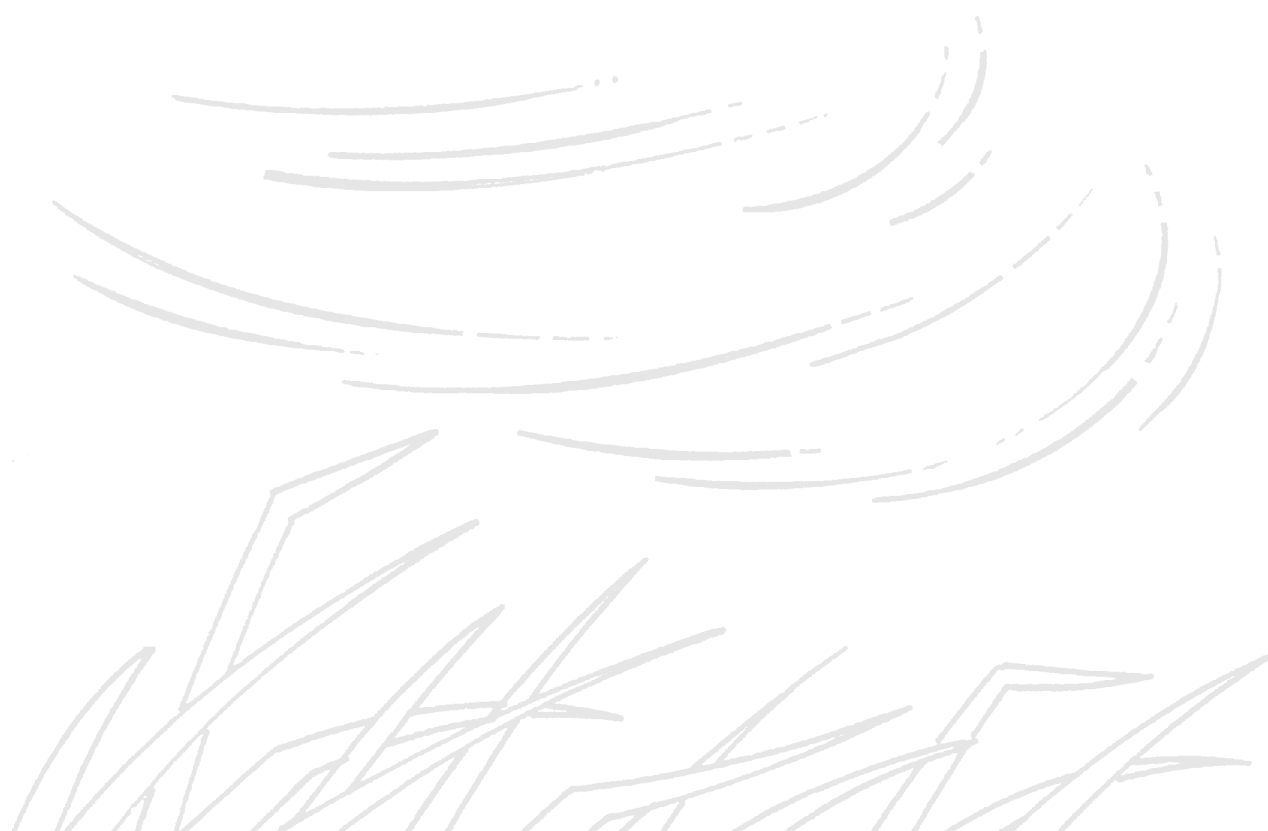

Instructors can:

- say a weather word and ask learners to point to it.
- show a weather word and ask learners to point to it.
- show learners a weather word and ask learners to read it.
- cut up the words and the pictures and mix them up. Ask learners to match the word with the picture.
- cut the words in half and ask learners to put them back together.
- copy and cut up two sets of words. Ask learners to match the same words.

Learners can:

- look at the pictures and read the words.
- copy the words on a separate paper.
- indicate likes and dislikes for weather.

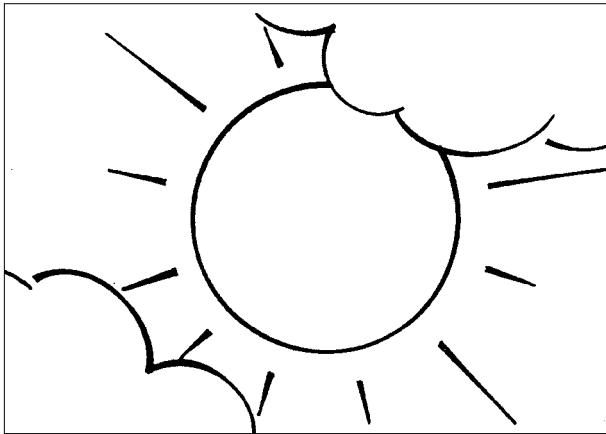

sunny

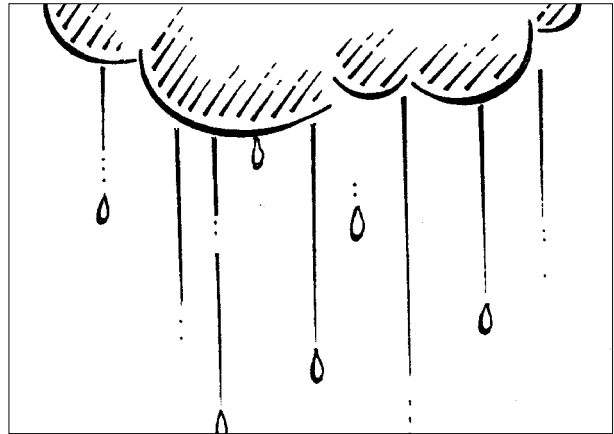

rainy



windy

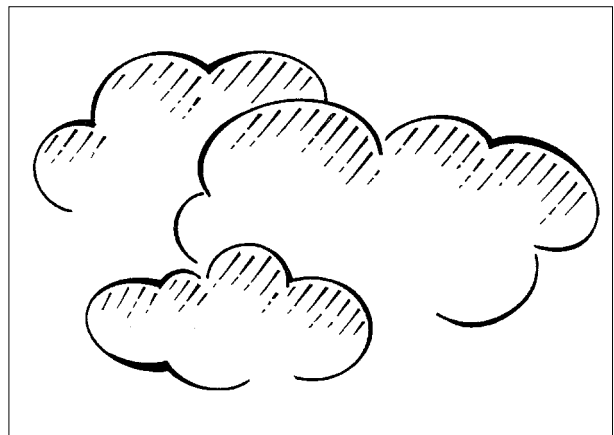

cloudy



snowy

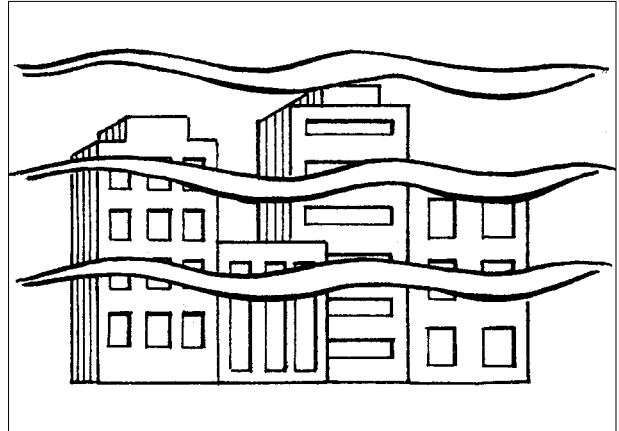

foggy



cold



hot

Instructors can:

- say a weather word and ask learners to point to it.
- show a weather picture and learners point to it.
- show a weather word and learners point to it.

Learners can:

- look at the picture and read the word.
- fill in the blanks.

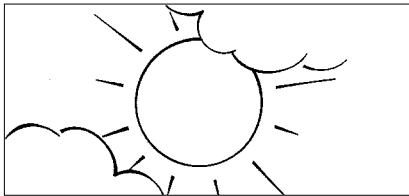

sunny

__unny

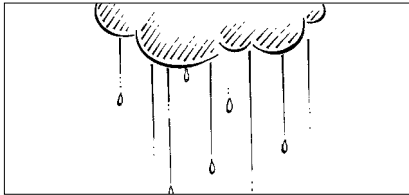

rainy

__ainy



windy

__indy

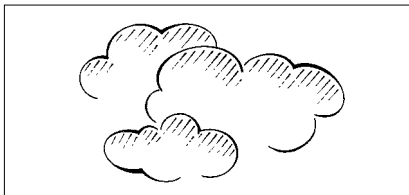

cloudy

__loudy



snowy

__nowy



hot

__ot

Instructors can:

- say the weather word as illustrated in the picture and ask learners to circle the word.
- show a weather word and ask learners to point to the same word.
- say a weather word and ask learners to circle all the same words on the page.

Learners can:

- circle the weather word that is the same as the picture.
 - cut up all the words and group the same words together.
 - copy the words onto separate paper.
-

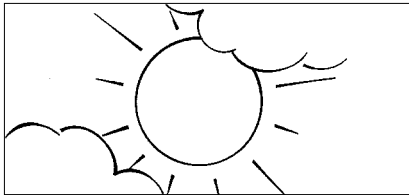

rainy sunny hot

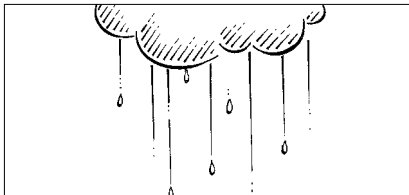

cloudy windy rainy



windy cold hot

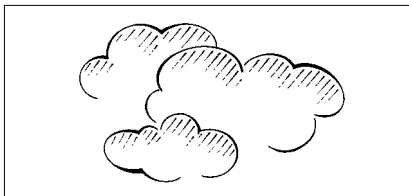

sunny foggy cloudy



snowy rainy windy



hot cold snowy

Instructors can:

- say the weather word and ask learners to write the word in the blank.
- show a weather word and ask learners to copy the word in the blank.
- show two weather words and ask learners to write the correct one in the blank.

Learners can:

- look at the picture and say the word.
- fill in the blanks.
- read the sentence.
- copy the sentence on to a separate page.

What's the weather today?

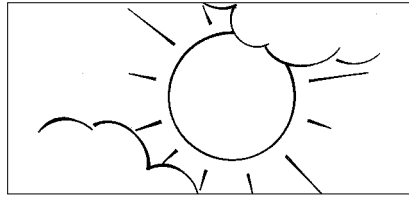

Today is _____.

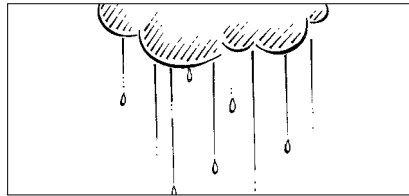

Today is _____.



Today is _____.

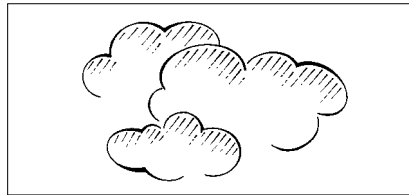

Today is _____.



Today is _____.



Today is _____.

Instructors can:

- ask learners, "What's the weather on Monday?" Ask learners to write the answer on a separate paper.
- show a weather word and learners write it in the blank.

Learners can:

- read the days and say the weather.
- write the weather word in the blanks.
- read the sentences.

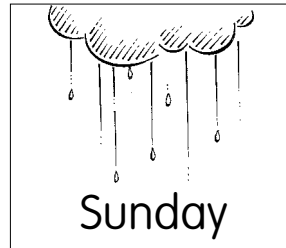
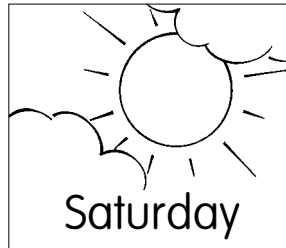
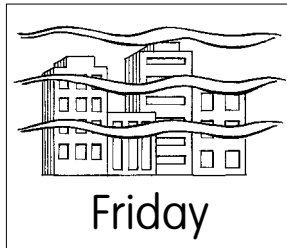
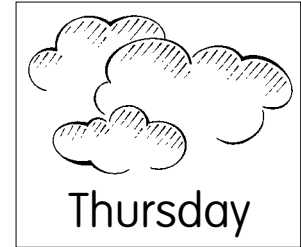
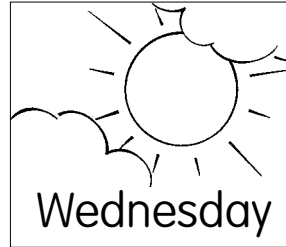
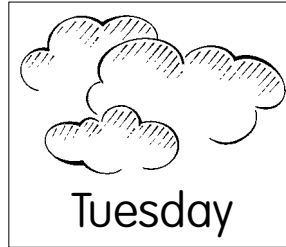
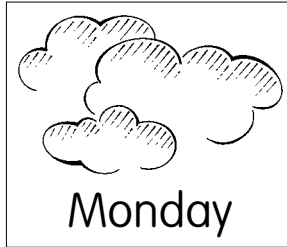

Monday is _____.

Tuesday is _____.

Wednesday is _____.

Thursday is _____.

Friday is _____.

Saturday is _____.

Sunday is _____.

Instructors can:

- cut out the sentences from the previous page. Ask learners to match the sentences from the previous page to the questions from this page.

Learners can:

- read the questions
- write the answers to the questions on a separate page.
- work in pairs. One learner has the previous page filled in. The other learner asks the question and writes what her partner says.
- during the week, learners keep track of the weather by filling out page 7.6 . At the end of the week, learners read the questions on this page and fill in the weather words.
- to make the previous activity more difficult, cut up these questions so they are not in order and do the same as the previous activity.

What's the weather on Monday? _____	What's the weather on Tuesday? _____	What's the weather on Wednesday? _____
What's the weather on Thursday? _____	What's the weather on Friday? _____	What's the weather on Saturday? _____

- Use this as a tool for teaching temperature.
 - Say a temperature and ask learners to point to that temperature on the thermometer.
 - Use it as a daily activity. Ask learners when they come in, "What's the temperature today?" and mark it on the picture.
 - It might be good to get this page laminated so it can be reused every day.
-

What's the temperature today?

It is _____.

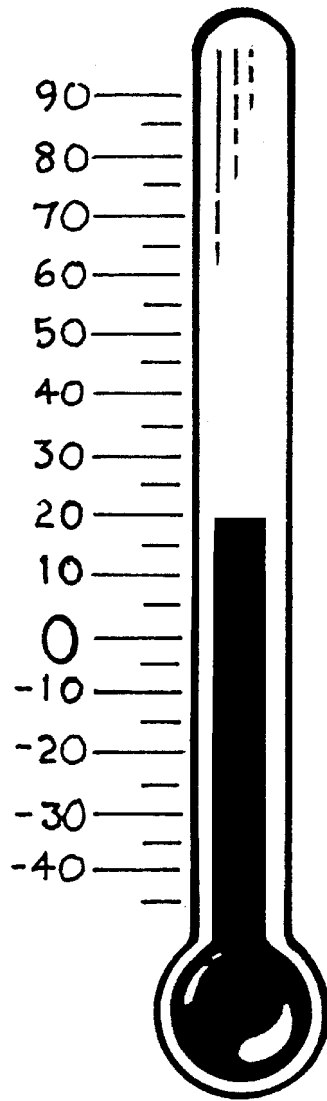

What's the weather today?
What's the temperature today?

Monday	Tuesday	Wednesday	Thursday	Friday	Saturday	Sunday
_____	_____	_____	_____	_____	_____	_____
_____	_____	_____	_____	_____	_____	_____

sunny

cloudy

windy

rainy

foggy

snowy

cold

hot

temperature	

EMERGENCY

911... What's your emergency?



Objective

To be able to call 911 in case of an emergency

Goal

To be able to identify an emergency.

Suggestions

- Suggest that learners have their civic address posted beside their phone. Ensure they can say it clearly as well as spell it. All members of the family should be able to say their address. If someone doesn't know their civic address in Nova Scotia they can call 1-800-388-3911.
- Review the dialog between 911 operator and person reporting the emergency often so learners are familiar with the words and questions from the 911 operator.
- Review appropriate reasons to go to Emergency at the hospital.
- Review any cost that might be associated with calling an ambulance or false 911 calls.
- Identify what an emergency is. The 911 coordinator reports that 911 assists people when there is a threat to one's health, safety or property.
- For the purpose of this exercise we are assuming that the emergency is at the learner's home.

Halifax Regional Municipality

Non-emergency police number	490-5020
General information for fire and emergency	490-5530
Poison control	428-8161
Incident report	490-5016

Activities

- Visit the 911 Center at 15 Convoy Run, in Bedford. Phone 490-7249/7250.
- Make cards with the pictures of the emergency on them. Role play emergency situations.

911 is for emergency situations only.

For more information on 911 contact the program administrator at Emergency Measures Organization, Nova Scotia Department of the Environment, P.O. Box 2107, Halifax, NS B3J 3B7 (902)424-5620.

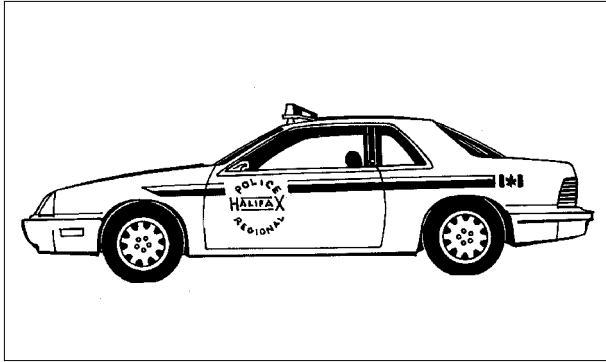

police car

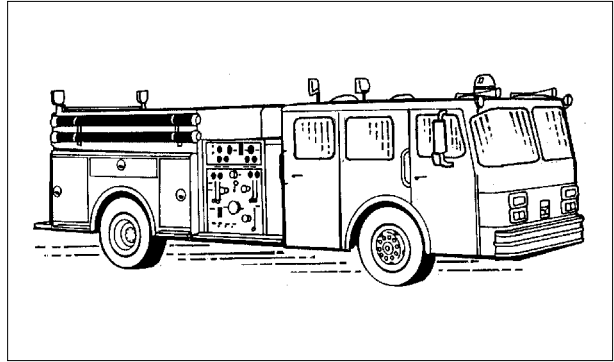

fire truck

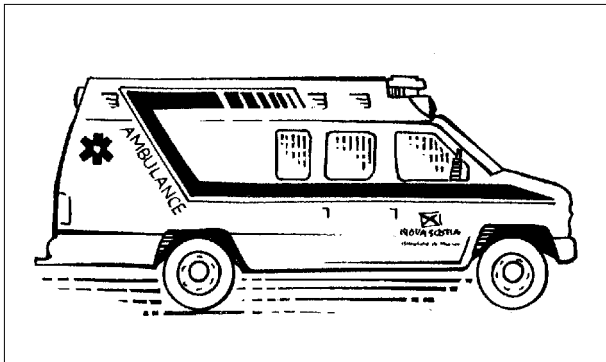

ambulance

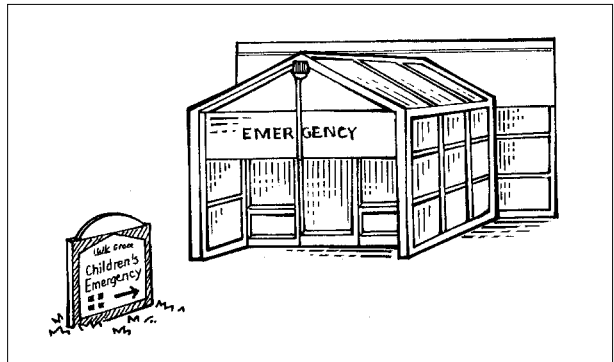

IWK emergency

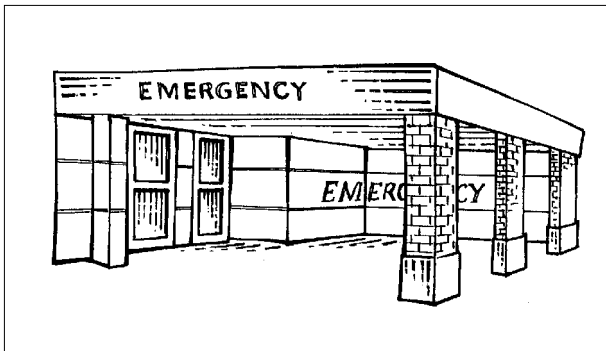

QEII

Instructors can:

- teach the vocabulary needed for this page.
- say an emergency situation on this page and ask learners to point to it.
- copy and cut the previous page. ask learners to match the appropriate picture with the emergency situation (i.e., police with break in).

Learners can:

- cut up the pictures and the words and match them.
- work in pairs. One partner says the emergency situation, the other learner points to it.
- work in pairs. One partner says the emergency situation, the other learner writes it on a separate paper. Take turns saying and writing the situations.
- work in pairs and role play. One partner takes the role of the 911 operator. The other reports the emergency.



drank poison

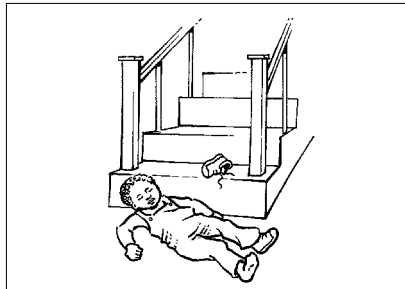

fell down



choking



heart attack

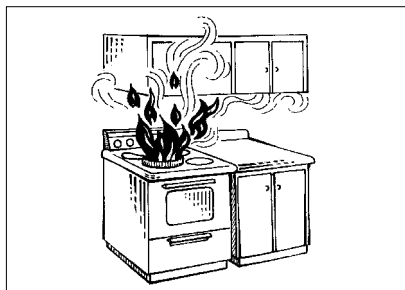

fire

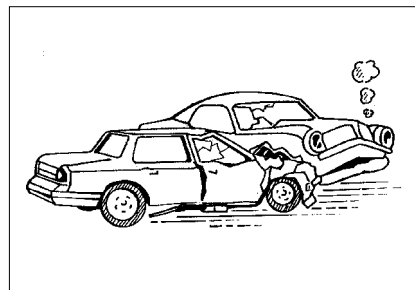

car accident

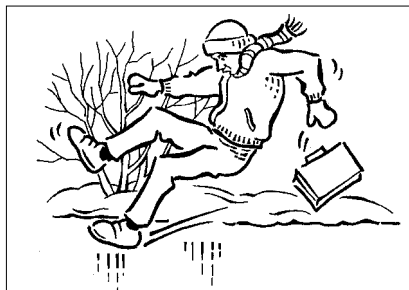

fell



break-in



electric shock

Instructors can:

- say the words and learners write the missing letters.
- spell the words and learners fill in the missing letters.
- create a similar worksheet with more or less blanked letters.
- create a similar worksheet with variations of spellings for each (e.g. helb, hel, help, holp).

Learners can:

- read the words on this page
 - copy the missing letters.
 - fold the paper and fill in the missing letters.
 - copy the words onto the lined paper.
-

help	__elp	hel__
call	__all	cal__
poison	__oison	poiso__
fire	__ire	fi__e
accident	__ccident	acciden__
police	__olice	po__ice
ambulance	__mbulance	am__ulance
emergency	__mergency	emer__ency
drink	__rink	drin__
choking	___oking	cho__ing
heart attack	__eart __ttack	hear__ attac__
fall	__all	fal__
break in	__reak __n	brea__ i__

Instructors can:

- read a word and ask learners to point to it.
- show learners the picture and ask learners to say the word or the problem.

Learners can:

- look at the picture and say the word.
 - circle the correct spelling.
 - copy the correct spelling on a separate paper.
-

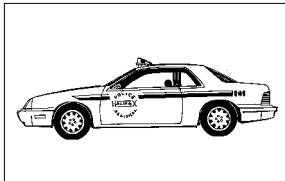

polise

police

bolice

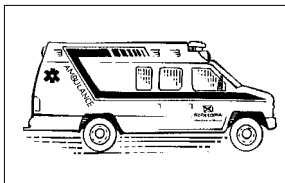

ampulance

ambulanse

ambulance

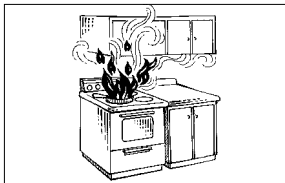

fire

fir

fier



poisin

boison

poison



hoking

choking

choki

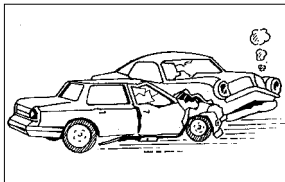

accident

acidnet

acciden

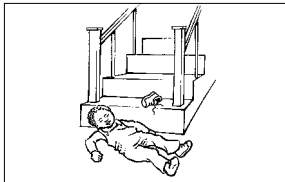

fel

fell

fal

Instructors can:

- say an emergency situation on this page and ask learners to point to it.
- show a picture and ask learners to read the sentence.
- white out one word in each sentence and ask learner to fill in the blanks.
- cut up each sentence and ask learners to put the words together to make a sentence.
- identify names of family members. Ask learners to substitute friends or family names or daughter/son when talking about emergencies.

Learners can:

- cut up the pictures from the sentences and match them.
- cut up the words and make different sentences (e.g., My daughter is choking). Learners can also write these new sentences on a separate sheet of paper.



My friend had a
heart attack.

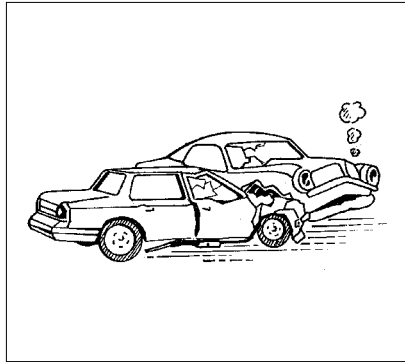

I had a
car accident.



My friend is
choking.

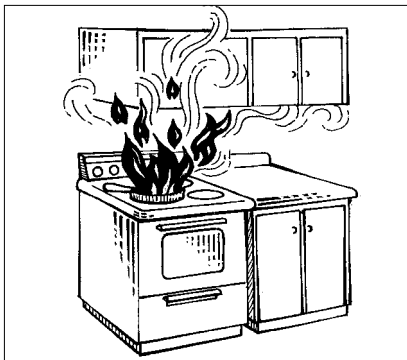

My apartment is
on fire.

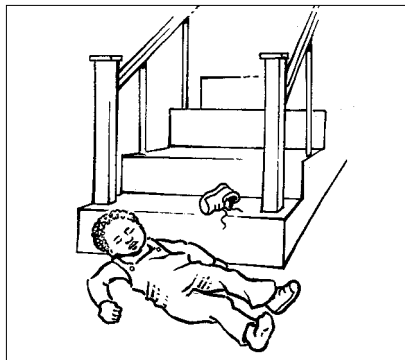

My daughter
fell down.

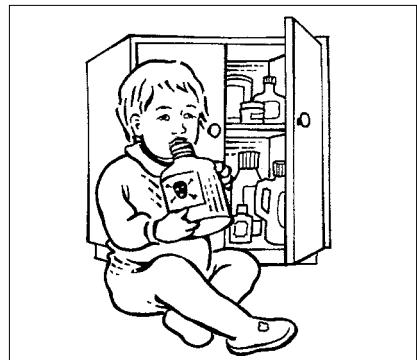

My son drank
poison.

Instructors can:

- point to a picture and ask learners to say what the emergency situation is.
- write the sentence on the chalkboard and ask learners to draw a line to separate the words.
- say the sentence clearly and ask learners to draw a line to separate the words.

Learners can:

- write the sentence on the line below making sure to separate each word.
- refer to the previous page for help in identifying separate words in the sentences.

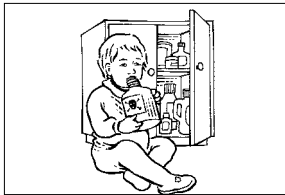

Mysondrankpoison.



Isawabreakin.

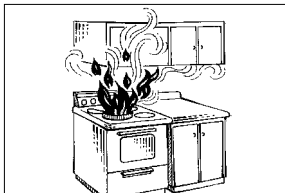

Myapartmentisonfire.

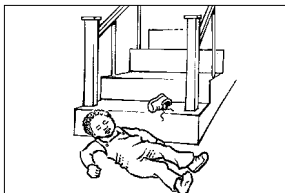

Mydaughterfelldown.



Myfriendhadaheartattack.



Myfriendischoking.

Instructors can:

- after learners fill in the boxes, cut up the page. Say an emergency situation on this page and ask learners to find the sentence and the picture.

Learners can:

- look at the pictures and write the emergency in the “what happened” box. Refer to the previous pages for help with spelling.
- look at the picture and write the phone number you would call. Write the phone number in the box.
- cut up the completed page, mix them up and match them.

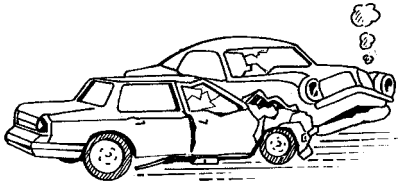
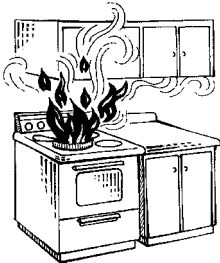
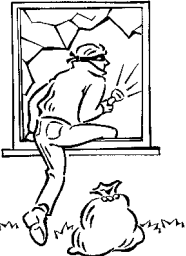
Emergency	What happened?	Phone number
		
		
		
		

Instructors can:

- review emergency situations in the pictures on this page.
- make a cassette with the following dialogues on it. Learners can follow the written dialog as they listen.
- read the dialog and ask learners to follow the written dialog.
- ask learners to say their address.

Learners can:

- write their address on the line.
 - work in pairs with one taking the role of the 911 operator and one reporting the emergency. Read the dialog.
 - practice the role play without reading the dialog.
-

name

street street
number number

apartment city
number

.....



“911...What is your emergency?”

My son drank poison.

“Is the emergency at _____?”
write your address

Yes.

“Stand by and I will connect you with the ambulance.”

.....

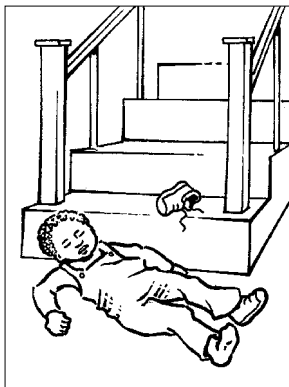

“911...What is your emergency?”

My daughter fell down.

“Is the emergency at _____?”
write your address

Yes.

“Stand by and I will connect you with the ambulance.”

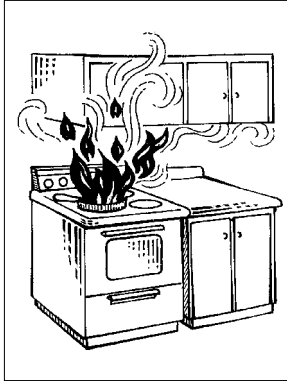

"911...What is your emergency?"

My apartment is on fire.

"Is the emergency at _____?"
write your address

Yes.

"Stand by and I will connect you with the fire department."



"911 What is your emergency?"

My friend had a heart attack.

"Is the emergency at _____?"
write your address

Yes.

"Stand by and I will connect you with the ambulance."



"911 What is your emergency?"

My friend is choking.

"Is the emergency at _____?"
write your address

Yes.

"Stand by and I will connect you with the police."

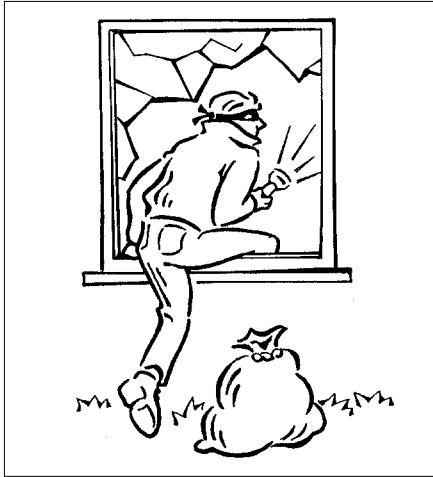

"911...What is your emergency?"

I saw a break in.

"Is the emergency at

_____?"

write your address

Yes.

"Stand by and I will connect you with the police."

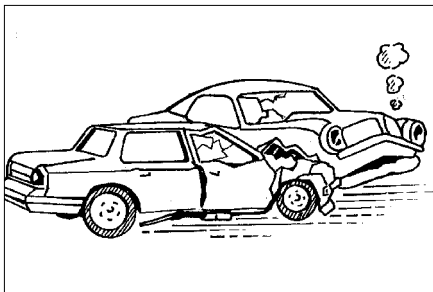

"911 What is your emergency?"

I had a car accident.

"Is the emergency at

_____?"

write the place of the accident

Yes.

"Stand by and I will connect you with the police."

police

ambulance

Emergency

QEII

drank poison

fell down

choking

accident

fire

heart attack

break-in

electric shock

COMMUNITY

Where's the library?

Objective

- To become familiar with community places in Halifax Regional Municipality.

Goals

- To recognize common street names.
- To identify common places in the Halifax Regional Municipality.

Suggestions

- Elicit what places learners visit frequently. Use these places as references in addition to the ones included in this chapter.
- It is important for newcomers to be comfortable in their community. Instructors can help newcomers become familiar with their English environment.
- Identify areas including downtown, North End, South End, Clayton Park, etc.
- The areas and activities illustrated in this chapter are not meant to be a complete list. You can teach many more verbs/activities for each place mentioned.
- Street names are usually written in upper case letters on street signs. Let learners know that when writing their address it is in lower case letters, but when they read signs, usually we see upper case letters.
- Cut out or delete names of places of no relevance to your learners (e.g. Access Nova Scotia in Dartmouth if learners live in Halifax).

Activities

- Go on tour! You can drive or walk around town identifying places already learned. Actually doing the activities mentioned here will reinforce the language learned. Take photographs of common street signs. Practice reading and pronouncing these names often.
- Ask learners to copy the street signs she sees on the way to school. Review these and practice the pronunciation regularly.
- Teach the question, "Where is ___?" Practice this question responding with common street names in your area.
- If learners go somewhere they like, encourage them to write the name of the place. Keep a file or poster on special places and review them often so learners are familiar with common place names in the area.

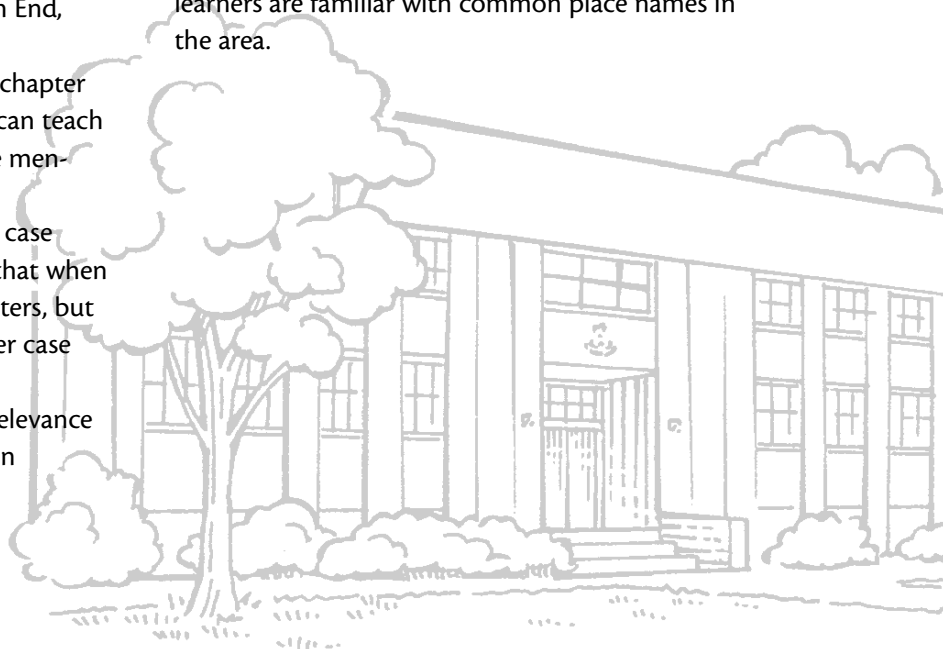

Instructors can:

- read the words on this page and ask learners to repeat the words.
- read the words on this page and ask learners to point to them.

Learners can:

- read the words on this page.
- work in pairs. One learner points to a picture and the other reads the word.
- cut up the pictures and the words, mix them up and match them.
- write the words on a separate paper.

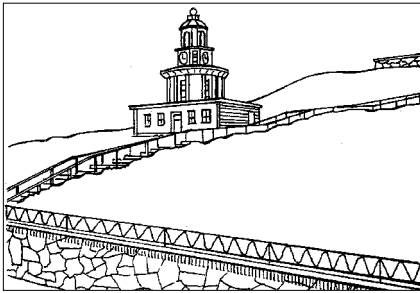

Citadel Hill

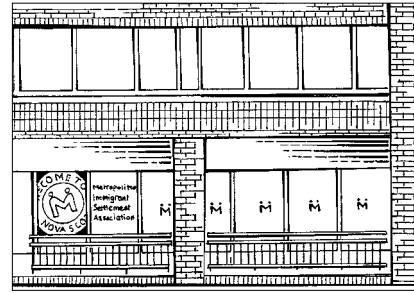

MISA

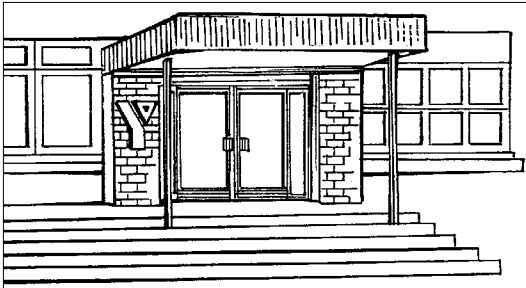

YMCA



Point Pleasant Park



Spring Garden Road

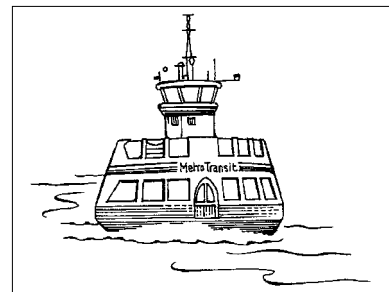

the ferry

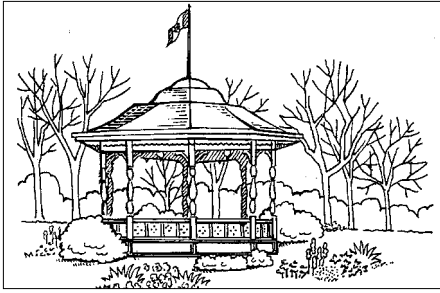

Public Gardens

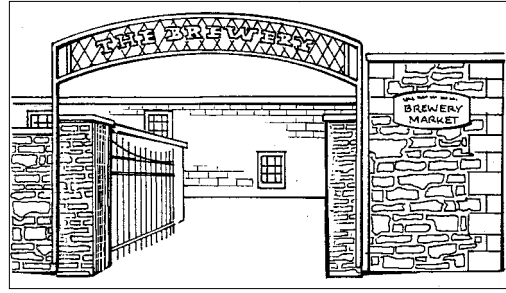

Farmers Market

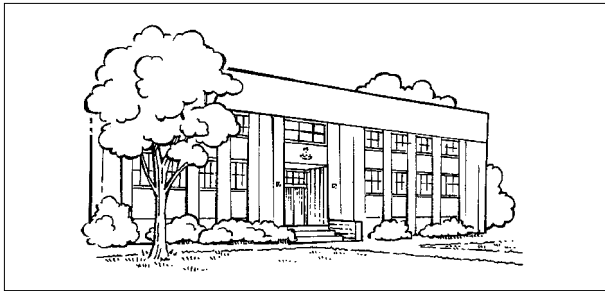

library

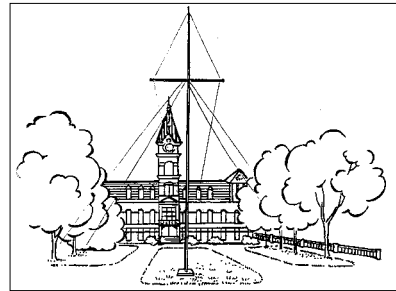

Grand Parade

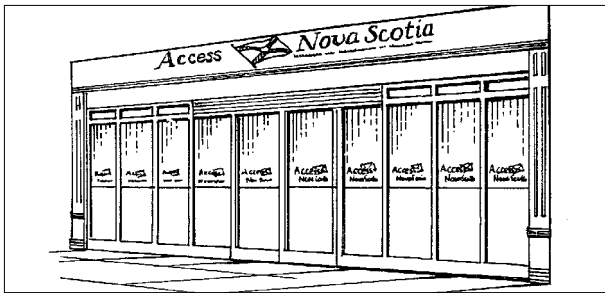

Access Nova Scotia

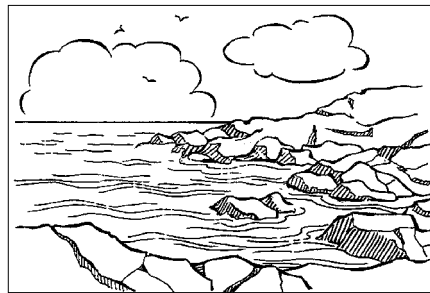

Peggy's Cove

Instructors can:

- create similar worksheets using common place names that are relevant to learners.
- read words this page and ask learners to point to them.

Learners can:

- read the words.
- copy the word in the blank.
- cover the first column. Write the words in lower case letters (except for the first letters) in the blanks.
- cover the second column. Write the words in all upper case letters in the blanks.
- cut up the words on this page. Mix them up and match the same words.
- write the words on a separate paper.

Citadel Hill	CITADEL HILL	_____
Grand Parade	GRAND PARADE	_____
Spring Garden Road	SPRING GARDEN ROAD	_____
ferry	FERRY	_____
Point Pleasant Park	POINT PLEASANT PARK	_____
Public Gardens	PUBLIC GARDENS	_____
Access Nova Scotia	ACCESS NOVA SCOTIA	_____
Farmers Market	FARMERS MARKET	_____
library	LIBRARY	_____
Peggy's Cove	PEGGY'S COVE	_____

Instructors can:

- read the words on this page and ask learners to repeat the words.
- read the words on this page and ask learners to point to them.
- cut out the pictures from this page and cut out the pictures of the places on pages 10.1-10.2. Match the place pictures with the activity pictures.

Learners can:

- read the words on this page.
- work in pairs. One learner points to a picture and the other reads the word.
- cut up the pictures and the words, mix them up and match them.
- write the words on a separate paper.

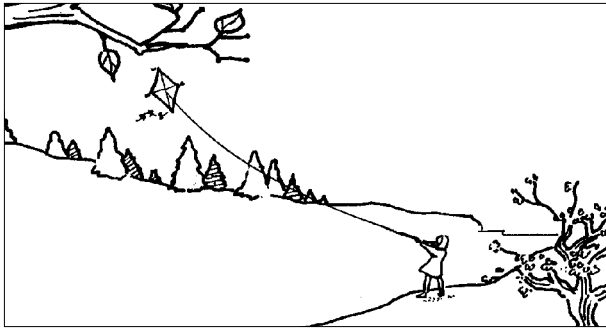

fly a kite

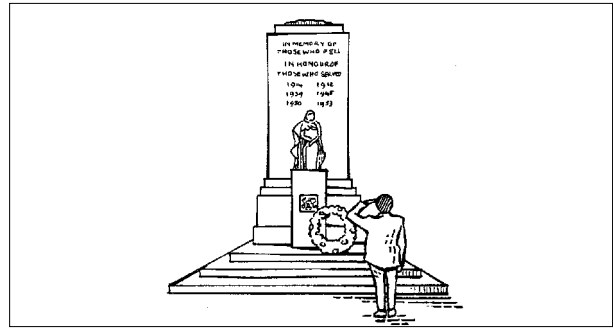

lay a wreath

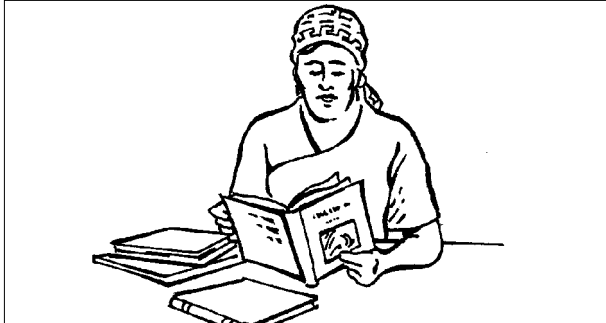

read a book

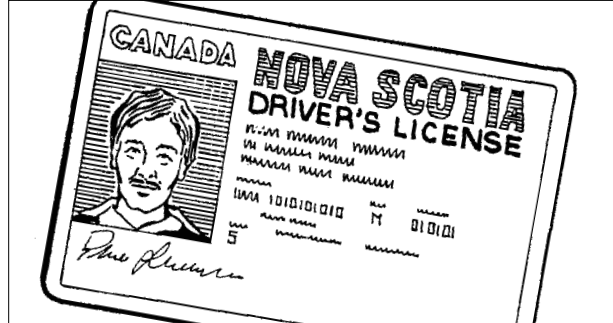

get a driver's license

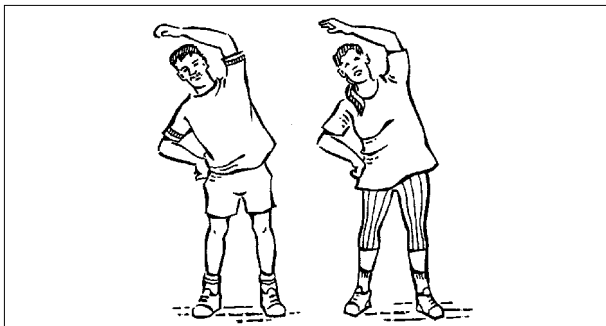

exercise

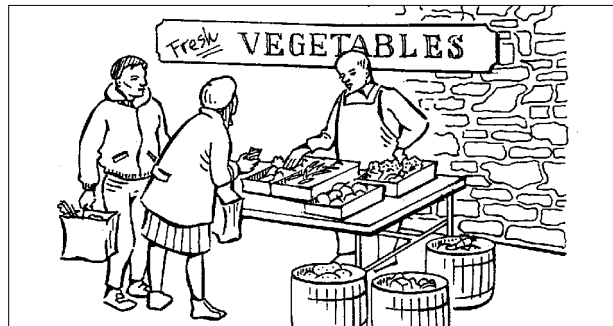

buy vegetables



go shopping



feed the ducks

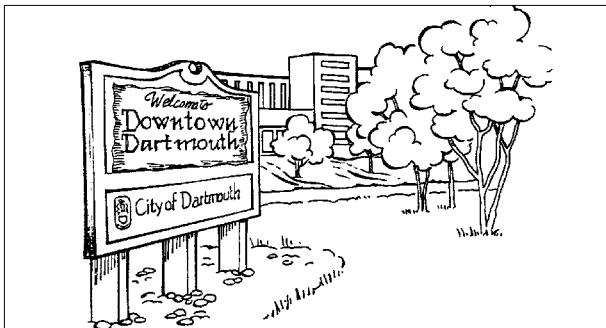

go to Dartmouth



have a picnic

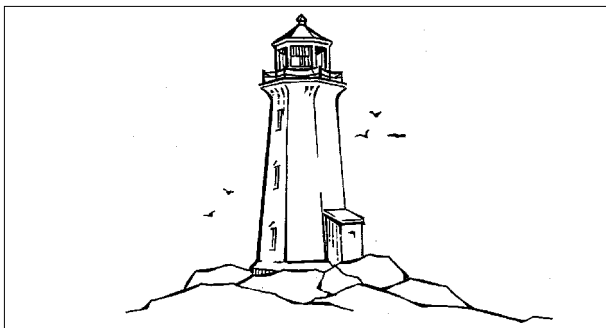

see the lighthouse



help

Instructors can:

- read each sentence and ask learners to read along.
- white out a word in each sentence and ask learners to fill in the blanks.
- read the sentences and ask learners to point to the picture.
- say the name of the place (e.g. "Public Gardens") and ask learners to point to it.

Learners can:

- read the sentences.
- cut up the pictures and the sentences. Mix them up and match the picture and the sentences.
- cut up the sentences, mix them up and put them back together.
- copy the sentences on a separate paper.

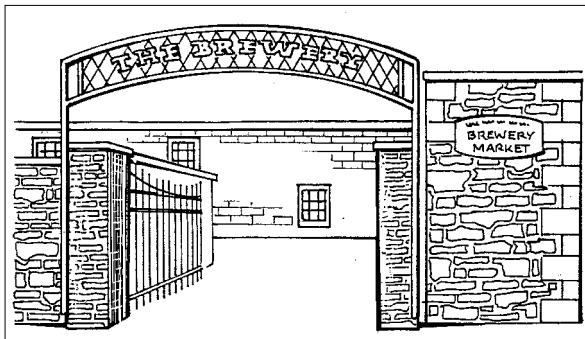

This is the Farmers Market.
You can buy vegetables at
the Farmers Market.

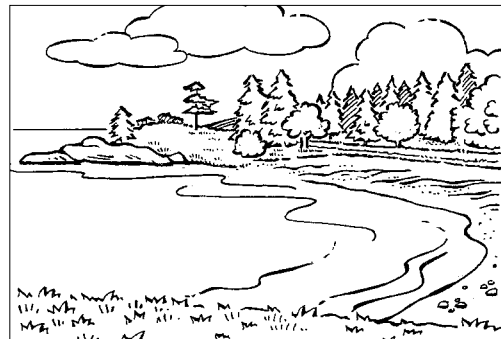

This is Point Pleasant Park.
You can have a picnic at
Point Pleasant Park.

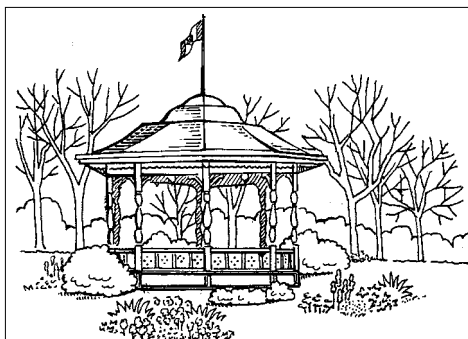

This is the Public Gardens.
You can feed the ducks at
the Public Gardens.

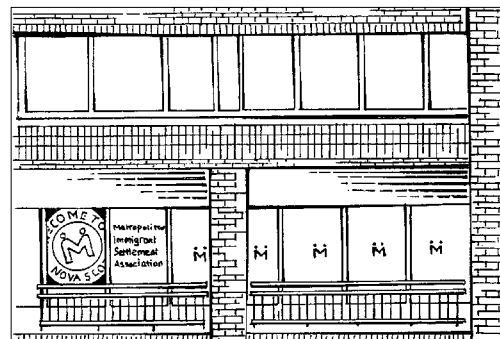

This is MISA.
You can go to MISA for help.

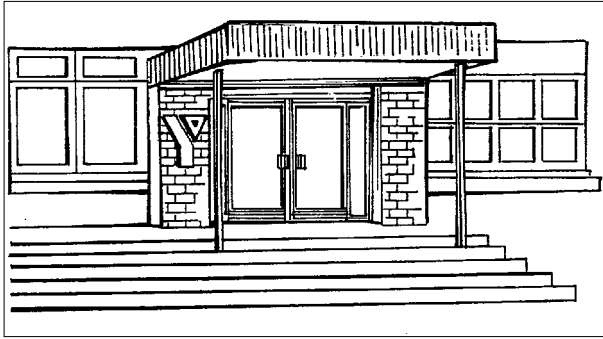

This is the YMCA.
You can exercise at
the YMCA.

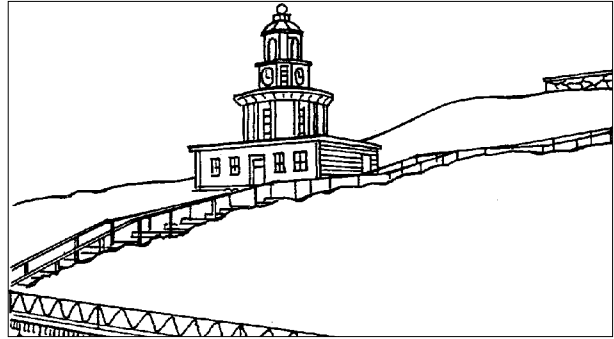

This is Citadel Hill.
You can fly a kite at
Citadel Hill.

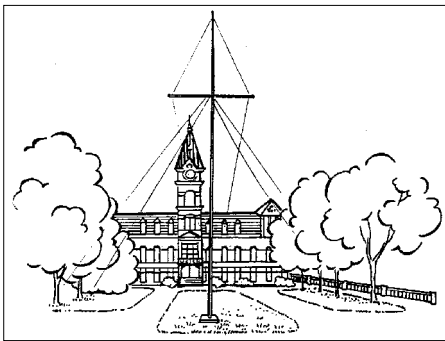

This is Grand Parade.
You can lay a wreath at the
Grand Parade.

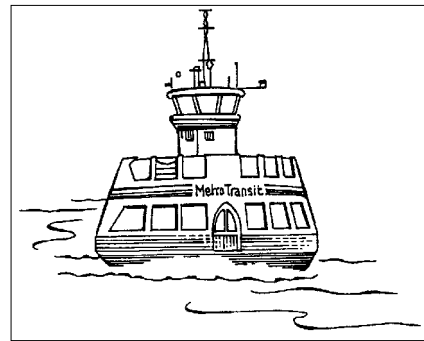

This is the ferry.
You can go to Dartmouth on
the ferry.

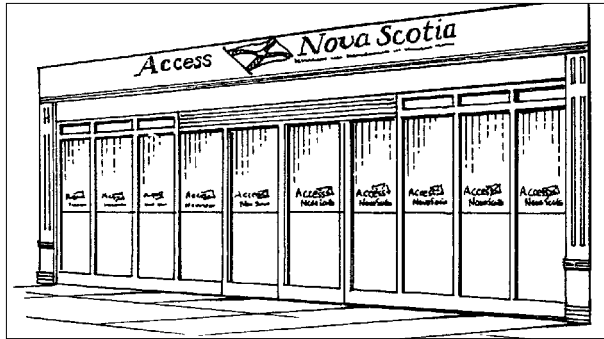

This is Access Nova Scotia.
You can get your driver's
license at Access Nova Scotia.



This is Spring Garden Road.
You can go shopping on
Spring Garden Road.

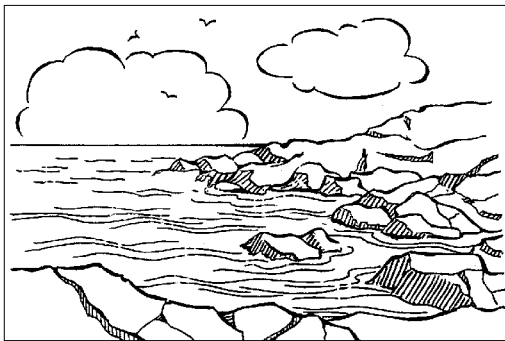

This is Peggy's Cove.
You can see the lighthouse
at Peggy's Cove.

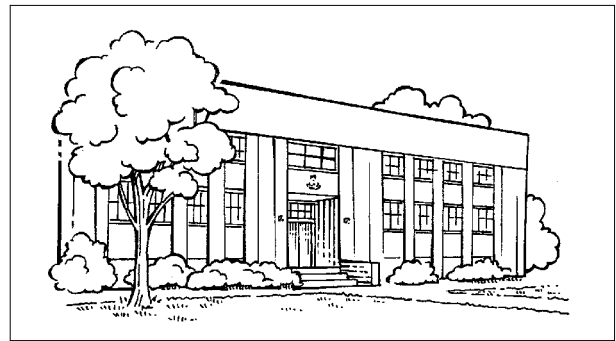

This is the library.
You can read at the library.

Instructors can:

- read the sentences on this page and ask learners to follow along.
- read the sentences on this page and ask learners to repeat.
- practice the question, "Where is ___?" with the information on this page.
- practice responding to the question, "Where is ___?" with the information on this page.
- white out the names of the places and ask learners to fill in the blanks.

Learners can:

- read the sentences on this page.
- cut up this page, separating the picture and the sentence. Mix them up and match the sentence with the picture.
- cut up the sentence, mix up the words, put the sentence back together.
- copy the sentences on a separate paper.

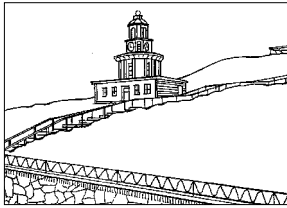

Citadel Hill is downtown Halifax.

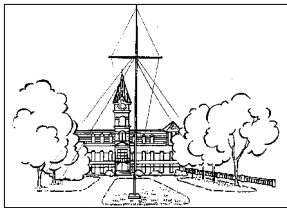

Grand Parade is on Barrington Street in Halifax.



Spring Garden Road is downtown Halifax.

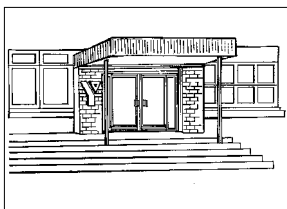

The YMCA is on South Park Street in Halifax.

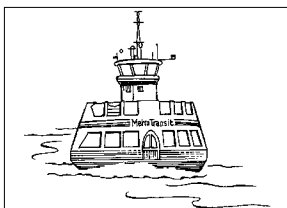

The ferry is on the waterfront in Dartmouth and in Halifax.

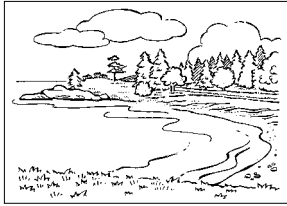

Point Pleasant Park is beside the water in South End Halifax.

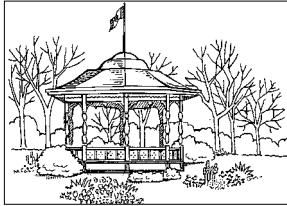

The Public Gardens are on the corner of Spring Garden Road and South Park Street in Halifax.

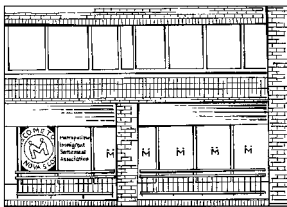

MISA is on Gottingen Street in Halifax.

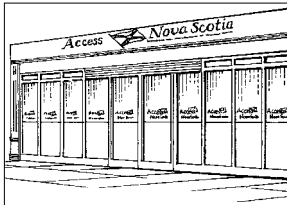

Access Nova Scotia is beside Sears in Halifax.
Access Nova Scotia is beside Zellers on Portland Street in Dartmouth.

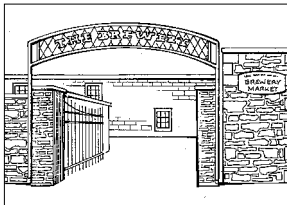

The Farmers Market is on Lower Water Street.

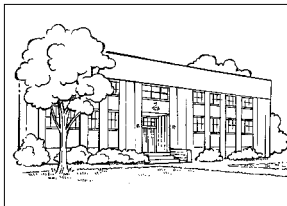

The library is across from Sobeys in Clayton Park.
The library is on Spring Garden Road in Halifax.
The library is on Alderney Drive in Dartmouth.



Peggy's Cove is about 50 kilometers from Halifax.

Instructors can:

- create similar worksheets using street names that are relevant to learners.
- read a street name on this page and ask learners to point to it.

Learners can:

- read the words.
 - copy the word in to the blank.
 - cover the first column. Write the words in lower case letters (except for the first letters) in the blanks.
 - cover the second column. Write the words in all upper case letters in the blanks.
 - cut up the words on this page. Mix them up and match the same words.
-

Barrington Street BARRINGTON STREET _____

Brunswick Street BRUNSWICK STREET _____

Spring Garden Road SPRING GARDEN ROAD _____

South Park Street SOUTH PARK STREET _____

Lower Water Street LOWER WATER STREET _____

Gottingen Street GOTTINGEN STREET _____

Mumford Road MUMFORD ROAD _____

Instructors can:

- do this activity only after learners have a good understanding of the places and street names in this chapter.
- read the words on this page and ask learners to point to the same words.
- cut up this page and ask learners to match the place name with the street name/area.
- cut out pictures of common places in the previous pages and ask learners to match them with the cut-out words from this page.

Learners can:

- read the words on this page.
- copy the words on this page on a separate paper.
- work in pairs. One learner has the place names, the other has the street names or areas. Practice asking the question, "Where is ___?" The partner finds the street name, reads it and gives it to his partner.

MISA	Gottingen Street	YMCA	South Park Street	Farmers Market	Lower Water Street
Citadel Hill	downtown Halifax	Point Pleasant Park	beside the water in South End Halifax	Grand Parade	Barrington Street
Spring Garden Road	downtown Halifax	Peggy's Cove	50 kilometers from Halifax	ferry	on the waterfront
library	across from Sobey's in Clayton Park	Access Nova Scotia	beside Sears in Halifax	Public Gardens	corner of Spring Garden Road and South Park Street
	Spring Garden Road in Halifax		beside Zeller's on Portland Street in Dartmouth		
	Alderney Drive in Dartmouth				

Instructors can:

- ask the questions on this page and learners point to the questions.
- ask a question and learners point to and read the answer.
- cut up the questions and answers, mix them up and match the questions with the answers.

Learners can:

- read the questions and the answers.
 - copy the questions to a separate page.
 - cut up the sentences into individual words and put the sentence together.
 - work in pairs. Learners ask each other the questions and read the answers.
 - fold the paper in half. Look at the questions and write the answers.
-

Where is MISA?

MISA is on Gottingen Street.

Where is the ferry?

The ferry is on the waterfront.

Where is the YMCA?

The YMCA is on South Park Street.

Where is the library?

The library is on across from Sobeys in Clayton Park.

The library is on Spring Garden Road in Halifax.

The library is on Alderney Drive in Dartmouth.

Where is Peggy's Cove?

Peggy's Cove is about 50 kilometers from Halifax.

Where is Citadel Hill?

Citadel Hill is downtown Halifax.

Where are the Public Gardens?

The Public Gardens are at the corner of Spring Garden Road and South Park Street.

Where is Grand Parade?

Grand Parade is on Barrington Street.

Where is the Farmers Market?

The Farmers Market is on Lower Water Street in Halifax.

Where is Access Nova Scotia?

Access Nova Scotia is beside Sears in Halifax.

Access Nova Scotia is beside Zellers on Portland Street in Dartmouth.

Where is Point Pleasant Park?

Point Pleasant Park is beside the water in South End Halifax.

Where is Spring Garden Road?

Spring Garden Road is in downtown Halifax.

Citadel Hill

MISA

YMCA

Point Pleasant
Park

Spring Garden
Road

ferry

Public Gardens

Farmers Market

library

Grand Parade

Access
Nova Scotia

Peggy's Cove

fly a kite

lay a wreath

read a book

get a
driver's license

exercise	buy vegetables
go shopping	feed the ducks
go to Dartmouth	have a picnic
see the lighthouse	help

Barrington Street	Brunswick Street
South Park Street	Lower Water Street
Gottingen Street	Mumford Road

PARTS of the BODY

How's your foot?

Objective

To identify basic parts of the body.

Goal

To learn the names of the basic parts of the body.

Suggestions

There are many parts of the body to learn. Begin with the basic parts and then when learners are ready, introduce more vocabulary.

Activities

- Draw or trace a body, preferably you or a child, on a large piece of newsprint. Give learners pieces of paper with the parts of the body written on them. Ask learners to match the words with the appropriate part of the body.
- Role play doctor/client scenarios with the doctor asking, "How's your ___?"
- Introduce common instructions that the doctor would say such as, lift your arm, turn your head, bend your finger, etc. Practice these instructions orally and ask learners to do the action. Write these instructions on a card, show the card to learners and ask learners to do these actions.



Instructors can:

- say a word on this page and ask learners to point to it.
- write these words on separate pieces of paper. Show a word on this page and ask learners to point to the same one on the page.
- white out the first letter in the word and ask learners to fill in the missing letters.
- make two copies of the words below, cut them up and ask learners to match the same words.

Learners can:

- read the words.
- copy the words onto a separate paper.
- cut up the pictures and the words, mix them up, and match them.
- cut the words in half, mix them up and match them.

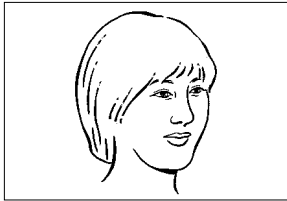

head

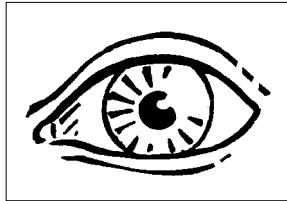

eye

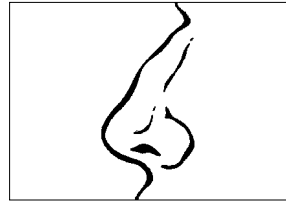

nose

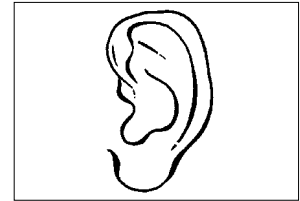

ear

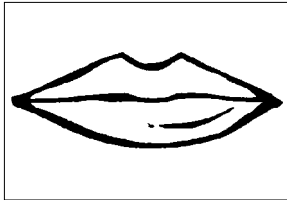

mouth

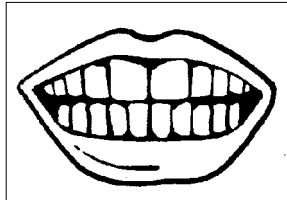

teeth

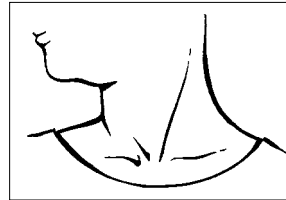

neck

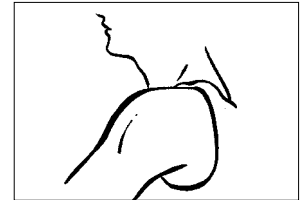

shoulder

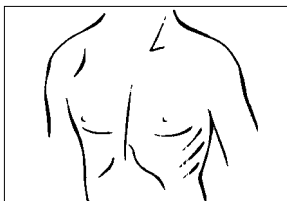

chest

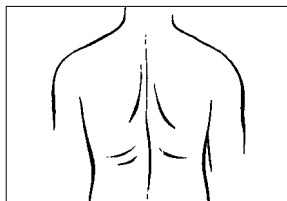

back

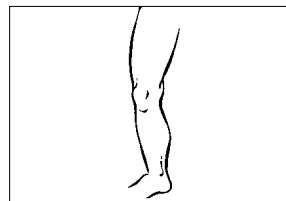

leg

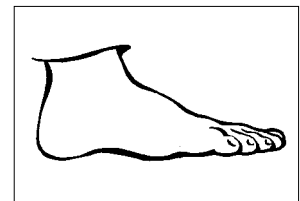

foot

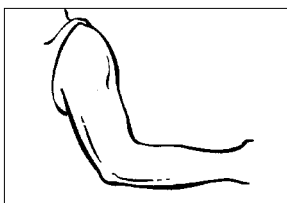

arm

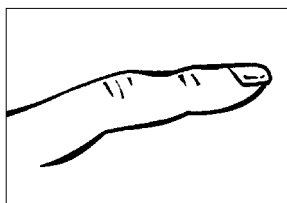

finger

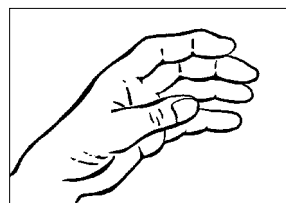

hand

Instructors can:

- say a word and ask learners to circle it.
- write these words on separate pieces of paper.
Show a word on this page and ask learners to count how many are on the page.
- show a word and ask learners to circle that word on the page.
- say the first word in each line and ask learners to repeat the word.

Learners can:

- read the first word on each line and circle the word that is the same.
- cut up the words and group the same words together.
- copy the words on to a separate paper.

head	back	eye	head
eye	eye	arm	foot
ear	hand	ear	leg
teeth	finger	hand	teeth
back	teeth	hand	back
leg	leg	ear	foot
foot	hand	foot	head
arm	arm	ear	teeth
finger	hand	eye	finger
hand	leg	finger	hand

Instructors can:

- look at the pictures and say the words. Ask learners to write the first letters in the blanks.
- say a word on this page and ask learners to point to the picture.
- create similar worksheets blanking out different letters.

Learners can:

- look at the picture and say the word.
- fill in the blank with the missing letter. Refer to page 10.1 for help.
- work in pairs. One learner has this page and the other learner has page 10.1. Practice asking each other, "How do you spell 'eye'?". Learners write the missing letters in the blanks.
- copy these words on a separate page after the blanks are filled in.

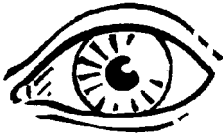

__ye



__ose



__outh



__houlder



__and

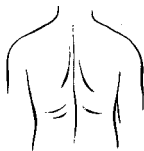

__ack



__inger



__ead



__ar



__eeth



__eck



__eg



__oot







__rm

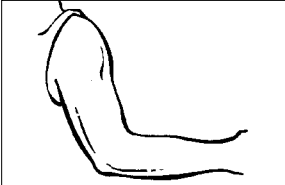
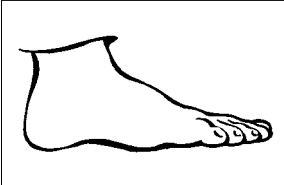
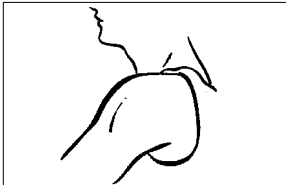
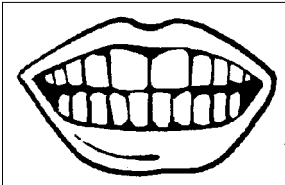
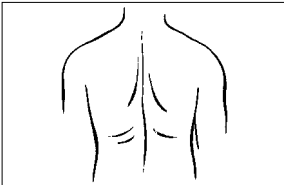
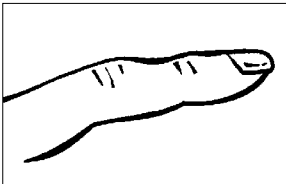
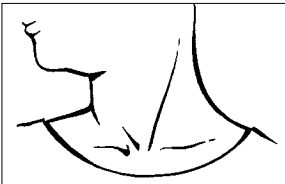
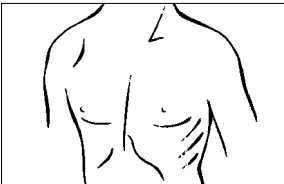

Instructors can:

- say the word and ask learners to circle the correct picture.
- say the word and ask learners to circle all the pictures of that word.

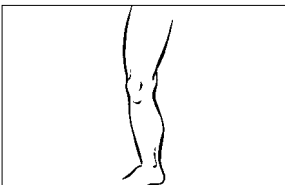
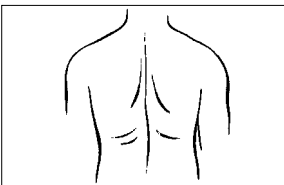
Learners can:

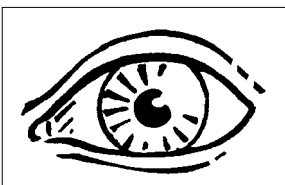
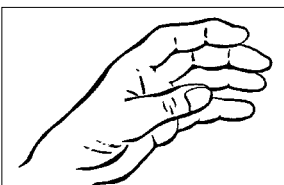
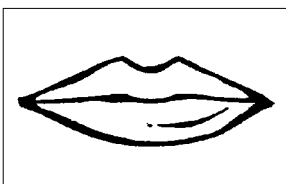
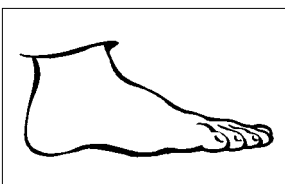
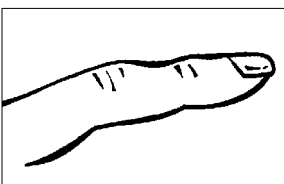
- read the word and circle the correct picture.
- write the words below the pictures.

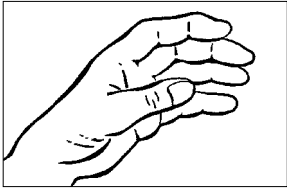
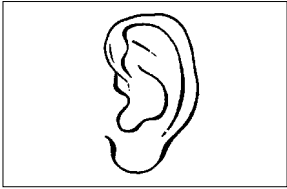
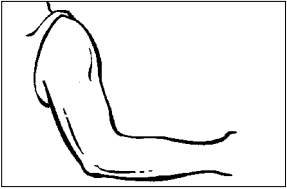
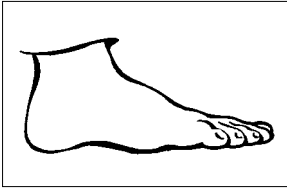
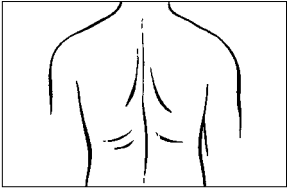
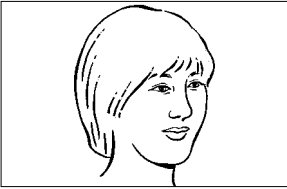
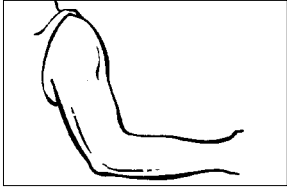
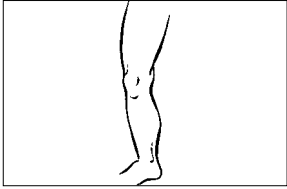
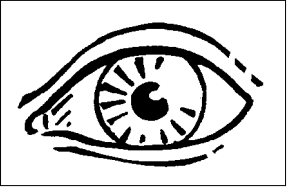
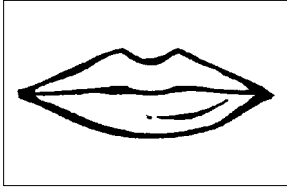
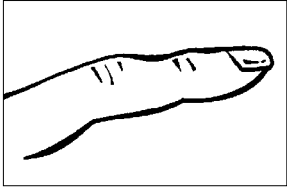
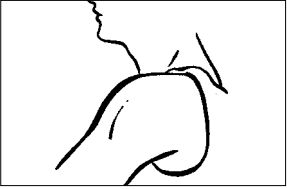
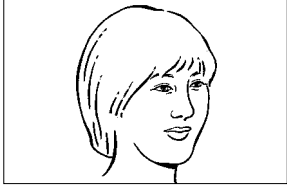
arm			
back			
chest			
ear			
eye			
finger			

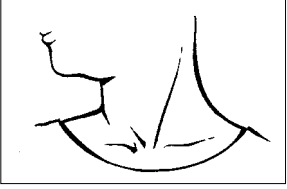
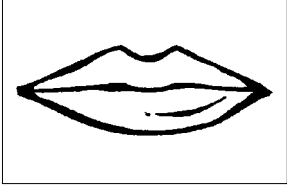
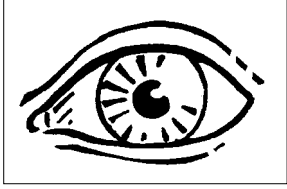
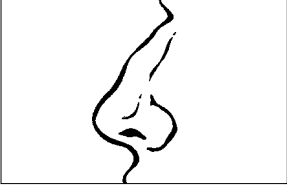
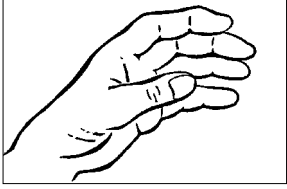
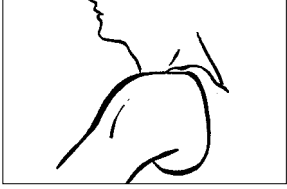
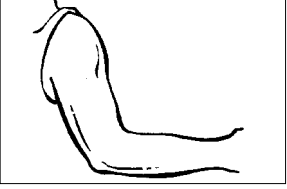
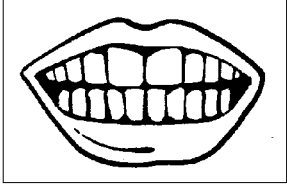
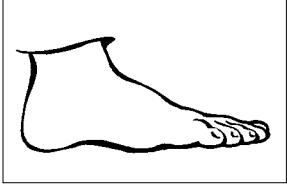
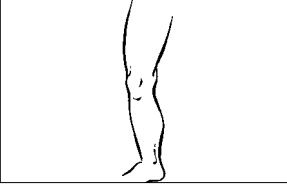
hand			
head			
leg			
mouth			
neck			
nose			
shoulder			
teeth			

Instructors can:

- say a word on this page and ask learners to point to it.
- say a word on this page and ask learners to write the word in the blank.
- write these words on separate pieces of paper. Show learners a word and ask them to point to the same word.
- fill in some of the blanks to make the activity easier.

Learners can:

- look at the pictures and read the words beside the pictures.
 - copy the words into the blanks.
 - fold the paper so the words are hidden and write the words in the blanks.
 - work in pairs. Cut the words off this paper. Cut the list of words in half. She asks her partner, "How do you spell ___?" Her partner spells the word and she writes it in the blank.
-

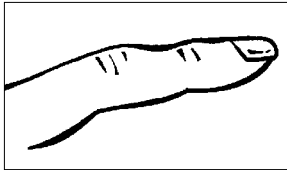

_____ finger

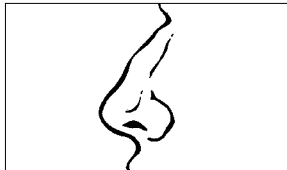

_____ nose

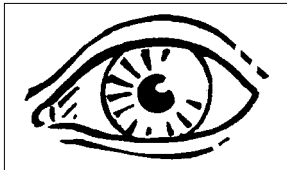

_____ eye

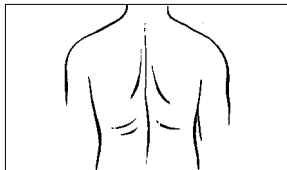

_____ back



_____ head



_____ teeth

Instructors can:

- write the words for the parts of the body on separate pieces of paper. Show the words and ask learners to write the words in the blanks.

Learners can:

- write the words in the blanks.

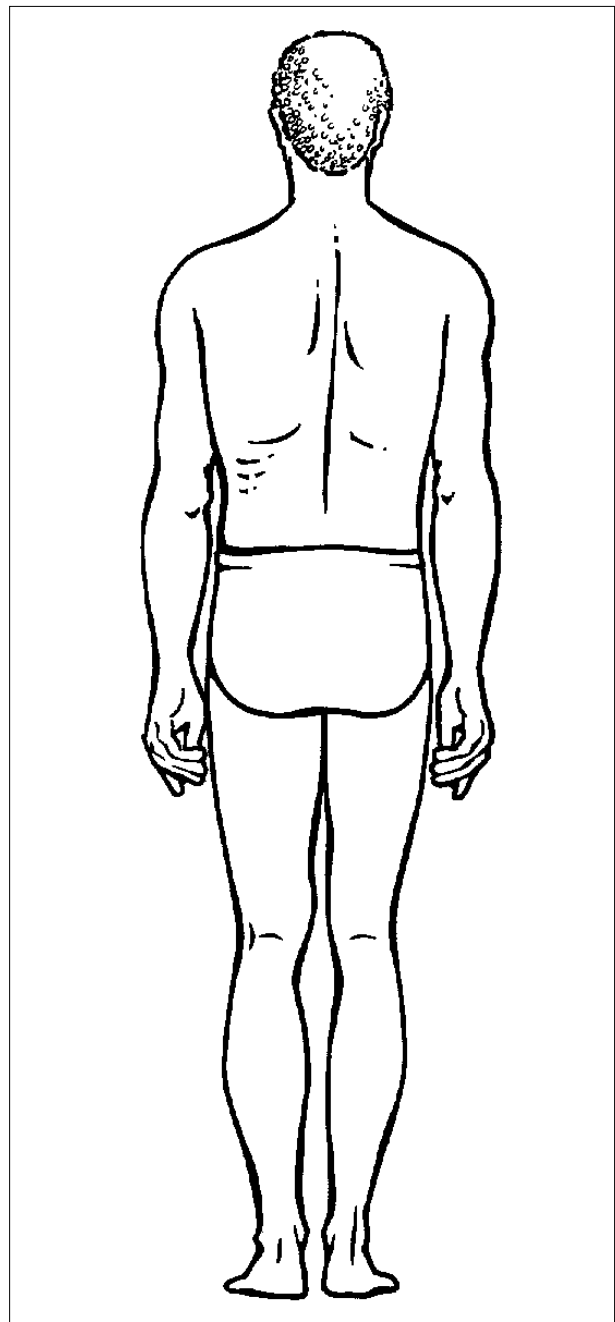
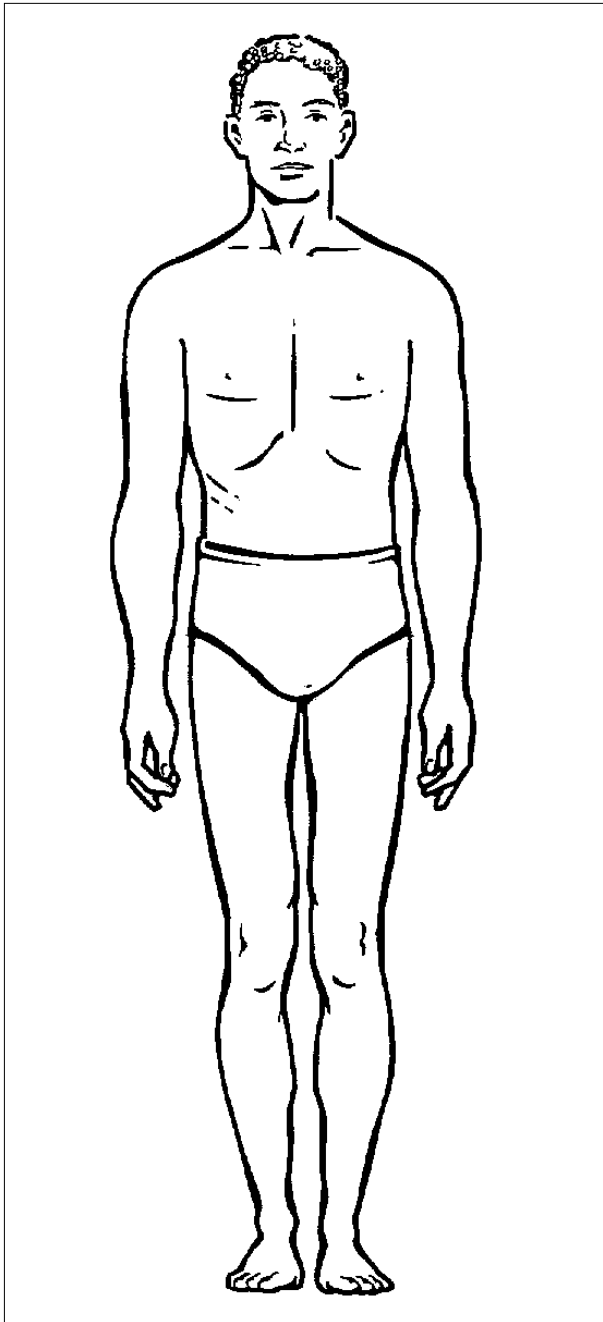



Instructors can:

- introduce the word 'hurt' and the question, "How's your ___?"
- say a word on this page and ask learners to point to it on this page.
- show a word from this page and ask learners to point to it on this page.
- show a word from this page and ask learners to read it.

Learners can:

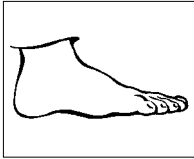
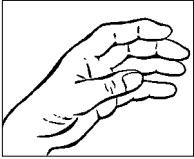
- read the sentences.
 - copy the words into the blanks.
 - complete the sentences by writing the words in the blanks.
 - fold the paper, look at the picture and write the word on a separate paper.
 - copy the sentences on a separate paper.
-

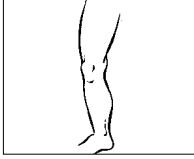
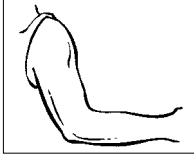
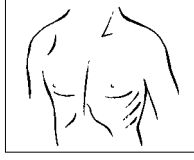
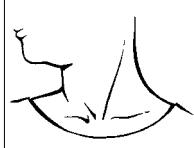

My		hurts.	foot _____	My _____ hurts.
My		hurts.	hand _____	My _____ hurts.
My		hurts.	eye _____	My _____ hurts.
My		hurts.	leg _____	My _____ hurts.
My		hurts.	arm _____	My _____ hurts.
My		hurts.	chest _____	My _____ hurts.
My		hurts.	neck _____	My _____ hurts.

Instructors can:

- introduce the word 'swollen' and the question, "How's your ___?"
- review the parts of the body.
- say a word on this page and ask learners to point to it on this page.
- show a word from this page and ask learners to point to it on this page.
- show a word from this page and ask learners to read it.

Learners can:

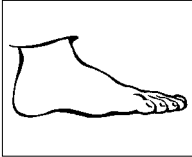
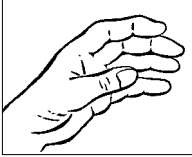
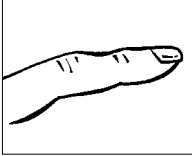
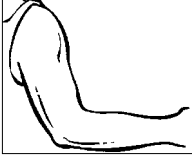
- read the sentences.
- copy the words into the blanks.
- complete the sentences by writing the words in the blanks.
- fold the paper, look at the picture and write the word on a separate paper.
- copy the sentences on a separate paper.

My		is swollen.	foot _ _ _ _ _	My _____ is swollen.
My		is swollen.	hand _ _ _ _ _	My _____ is swollen.
My		is swollen.	finger _ _ _ _ _	My _____ is swollen.
My		is swollen.	arm _ _ _ _ _	My _____ is swollen.
My		is swollen.	eye _ _ _ _ _	My _____ is swollen.

CROSSWORD PUZZLE

Instructions:

For this activity, learners work in pairs. Copy both crossword puzzles and give one to each learner. Teach the words across and down. Review numbers 1-13. Review the question, "How do you spell ___?" The object is for learners to fill in the blanks in their crossword puzzle. Learner A has the paper with the down words filled in. Learner B has the paper with the across words filled in. Learner A asks Learner B,

"What is number 1 across?" Learner B can either look at the picture or the word for number 1 across and points to her mouth. Learner A says 'mouth' and asks Learner B, "How do you spell mouth?" Learner B spells mouth as Learner A writes the letters in the spaces. Learners take turns asking questions until all the spaces are filled in the crossword puzzle.

Across →

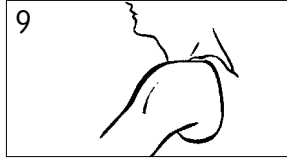
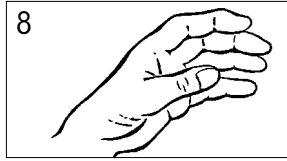
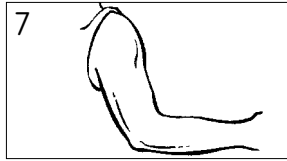
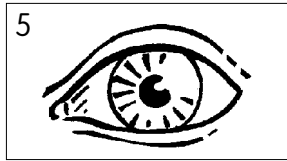
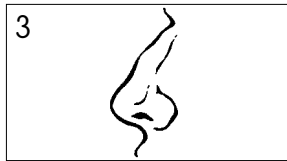
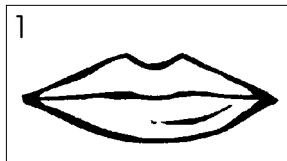

1	m	o	u	t	2	h		3	n	o	s	4	e	
					5	e	y	e						
	6									7	a	r	m	
		8	h	a	n	d								
		9	s	h	o	u	10	l	d	e	r			
					11	f	i	n	g	e	r			
										12	b	a	c	k
					13	t	e	e	t	h				

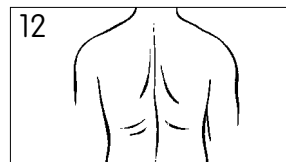

Down ↓

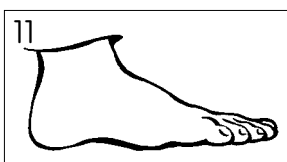
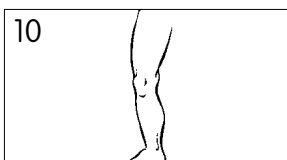
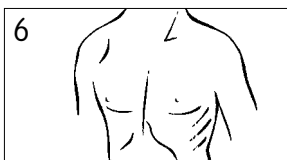
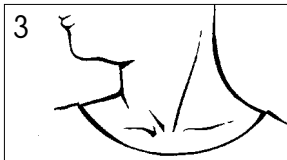
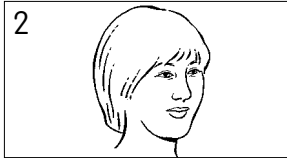

1				2	h		3	n			4	e	
				5	e			e				a	
		6	c								7	r	
		8	h					d					
			e										
		9	s					10	l				
			t						e				
					11	f							
						o							
						o					12		
					13	t							

head

eye

nose

ear

mouth

teeth

neck

shoulder

chest

back

leg

foot

arm

finger

hand

hurts

swollen	

FAMILY

What's your daughter's name?



Objective

To identify family members.

Goal

To ask and respond to questions about families.

Suggestions

- **Be cautious when doing any activity in this chapter. Be sensitive to learners' family situations.** Almost all learners will be separated from family members in one way or another. Begin with identifying members of your family and allow those who want to talk about family to participate and respect those who don't want to talk about it.
- This chapter focuses on the immediate family members. As learners are ready, introduce the extended members of the family.
- If someone's family member is no longer with them, it is important to be able to know the English words that describe their situation. Words such as 'divorced', 'separated', 'dead', 'missing', 'widowed', etc. are important. Introduce these words where and when appropriate and always taking the lead from the learner.
- In some cultures people are encouraged to marry cousins. Be careful of your reaction to this information as it may be interpreted as negative and disapproving, thus creating an atmosphere of non-supportiveness.

- Newcomers with large families often dread the question, "How many children do you have?" When they respond with, "I have nine children", they are met with mixed reactions which may set up immediate barriers. It is important to react positively.

Activities

- Bring photos of your family members and talk about them in class. Be cautious about asking learners to bring photos as many don't have photos with them.
- Go to a card store and find cards for various family members' birthdays.
- Give each learner a card with their spouse's/ children's names on it for easy reference.

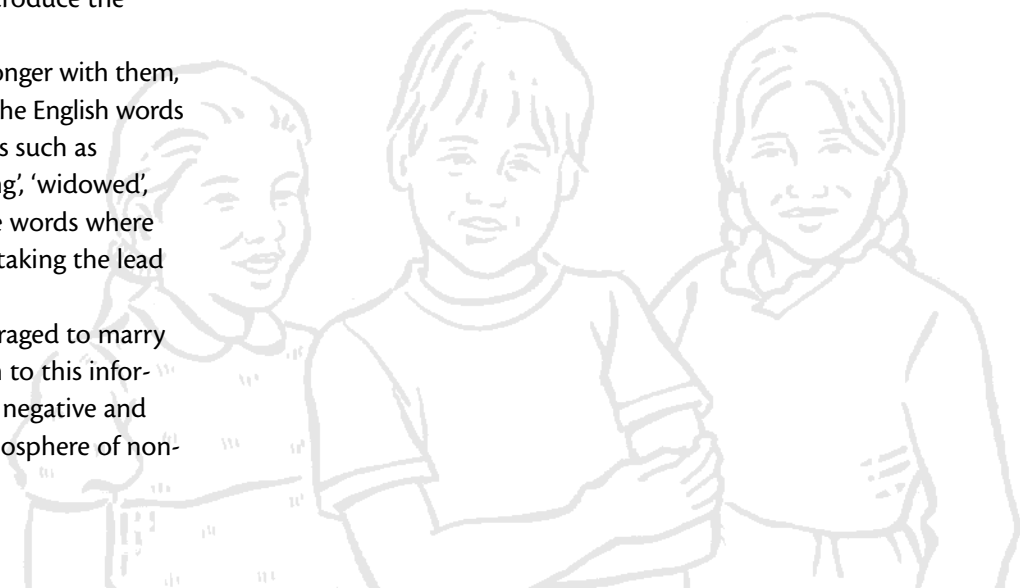



family



mother,
son, daughters

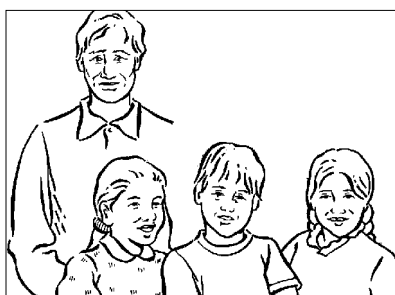

father,
son, daughters



sisters, brother

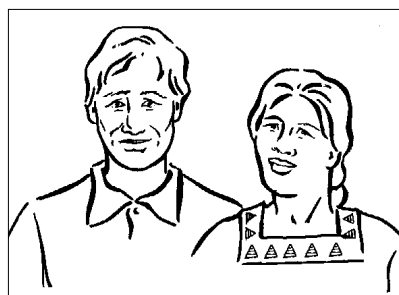

husband, wife

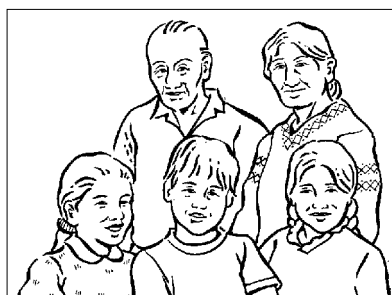

grandmother,
grandfather,
granddaughters,
grandson



Hello. My name is Maria.

This is my family.



This is my **mother**.



This is my **father**.



This is my **grandmother**.

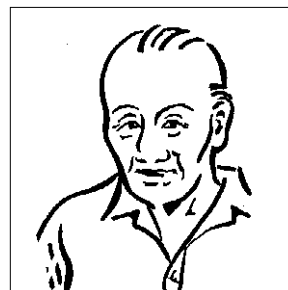

This is my **grandfather**.



This is my **sister**.



This is my **brother**.



Hello. My name is Robert.

This is my family.



This is my **wife**.



This is my **daughter**.

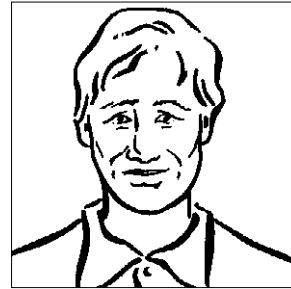

This is my **daughter's husband**.



These are my **granddaughters**



This is my **grandson**.

Instructors can:

- read the words and ask learners to point to them.
- make student centered worksheets by putting names of family members in the activity.

Learners can:

- circle the correct spelling.
 - copy the correct spelling onto a separate sheet of paper.
 - read the words on the left.
-

mother	mather	mother	mothr
father	father	fother	vather
son	sun	son	som
daughter	doughter	dauhter	daughter
grandmother	grandmother	grondmother	grandmather
grandfather	granfather	grandfathe	grandfather
brother	brother	brather	broter
sister	siser	sister	sisster
grandson	grandsun	granson	grandson
granddaughter	grandaughter	granddaughter	granddauhter
children	children	chidren	childen
parents	parants	parents	parens
grandchildren	grandchildren	grandchilden	gradchildren

Instructors can:

- say the words on this page and ask learners to repeat the words.
- say the words on this page and ask learners to point to the words.

Learners can:

- read the words on this page.
 - write the names of family members in the blanks.
 - copy these words on a separate paper.
-

daughters

sons

sisters

brothers

husband

wife

Instructors can:

- introduce the question, "How many ___ do you have?"
- introduce singular and plural forms.
- introduce the negative forms.

Learners can:

- read the sentences.
 - fill in the blanks with the correct number.
 - cut up the questions and answers. Match the question with the correct answer.
 - copy the sentences on a separate paper.
 - work in pairs and ask each other various questions using, "How many ___ do you have?"
-

How many sisters do you have?

I have ___ sisters.

I don't have any sisters.

How many brothers do you have?

I have ___ brothers.

I don't have any brothers.

How many children do you have?

I have ___ children.

I don't have any children.

How many daughters do you have?

I have ___ daughters.

I don't have any daughters.

How many sons do you have?

I have ___ sons.

I don't have any sons.

Instructors can:

- introduce the question, "What's your ___ name?"
- cut up this page. Give learners the pieces that are relevant to them. For example, if a learner is single, don't give her the questions regarding husband. If a learner doesn't have any children, don't give him questions about children.
- make more copies of this page if learners have more children or siblings than are on this page.
- introduce possessives (e.g. son's name).
- introduce pronouns (e.g. my, his, her).

Learners can:

- read the sentences.
- fill in the blanks with a name.
- cut up the questions and answers. Match the question with the correct answer.
- copy the sentences on a separate paper.
- work in pairs and ask each other various questions using, "What is your ___ name?"

What's your name? My name is _____	What's your sister's name? My sister's name is _____
What's your brother's name? My brother's name is _____	What's your daughter's name? My daughter's name is _____
What's your son's name? My son's name is _____	What's your daughter's name? My daughter's name is _____
What's your son's name? My son's name is _____	What's your daughter's name? My daughter's name is _____
What's your wife's name? My wife's name is _____	What's your husband's name? My husband's name is _____

Instructors can:

- say a word on this page and ask learners to point to it.
- teach the word 'age'.
- say a word on this page and ask learners to say it.
- write learners' family members names on separate cards. Show a card to a learner and ask her to write the name in the appropriate blank.

Learners can:

- read the words on this page
 - write names in the blanks.
 - write ages in the blanks.
 - after writing all family members' names and ages, cut up this page, mix up the papers, and match each name with their age with the relationship word.
-

	name	age
you	_____	_____
daughters	_____	_____
	_____	_____
	_____	_____
sons	_____	_____
	_____	_____
	_____	_____
mother	_____	_____
father	_____	_____
sisters	_____	_____
	_____	_____
	_____	_____
brothers	_____	_____
	_____	_____
	_____	_____

Instructors can:

- introduce the question, "How old is your ___?"
- cut up this page. Give learners the pieces that are relevant to them. For example, if a learner is single, don't give her the questions regarding husband. If a learner doesn't have any children, don't give him questions about children.
- make more copies of this page if learners have more children or siblings than are on this page.
- Review my, his, her.

Learners can:

- read the sentences.
- fill in the blanks with an age.
- cut up the questions and answer. Match the question with the correct answer.
- copy the sentences on a separate paper.
- work in pairs and ask each other questions using, "How old is your ___?"

How old are you ? I am _____ years old.	How old is your sister ? My sister is _____ years old.
How old is your sister ? My sister is _____ years old.	How old is your brother ? My brother is _____ years old.
How old is your brother ? My brother is _____ years old.	How old is your daughter ? My daughter is _____ years old.
How old is your daughter ? My daughter is _____ years old.	How old is your son ? My son is _____ years old.
How old is your husband ? My husband is _____ years old.	How old is your wife ? My wife is _____ years old.
How old is your mother ? My mother is _____ years old.	How old is your father ? My father is _____ years old.

Instructors can:

- teach the words 'city' and 'country'.
- say a word on this page and ask learners to point to it.
- say a word on this page and ask learners to say it.
- write learners' family members names on separate cards. Show a card to a learner and ask her to write the name in the appropriate blank.
- on separate pieces of paper, write the names of the countries where learner's family members live.

Learners can:

- read the words on this page
- write names in the blanks.
- write country names in the blanks.
- after writing all family members' names and countries, cut up this page, mix up the papers, and match each name with where they live with the relationship word.

	name	city or country
you	_____	_____
daughters	_____	_____
	_____	_____
	_____	_____
sons	_____	_____
	_____	_____
	_____	_____
mother	_____	_____
father	_____	_____
sisters	_____	_____
	_____	_____
	_____	_____
brothers	_____	_____
	_____	_____
	_____	_____

Instructors can:

- introduce the question, "Where does your ___ live?"
- cut up this page. Give learners the pieces that are relevant to them. For example, if learners don't have any sisters, don't give them the questions regarding sisters. If learners don't have any children, don't give them questions about children.
- make more copies of this page if learners have more children or siblings than are on this page.

Learners can:

- read the sentences.
- fill in the blanks with a place.
- cut up the questions and answer. Match the question with the correct answer.
- copy the sentences on a separate paper.
- work in pairs and ask each other various questions using, "Where does your ___ live?"

Where do you live? I live in _____.	Where does your sister live? My sister lives in _____.
Where does your brother live? My brother lives in _____.	Where does your sister live? My sister lives in _____.
Where does your daughter live? My daughter lives in _____.	Where does your daughter live? My daughter lives in _____.
Where does your son live? My son lives in _____.	Where does your son live? My son lives in _____.
Where does your husband live? My husband lives in _____.	Where does your wife live? My wife lives in _____.
Where does your mother live? My mother lives in _____.	Where does your father live? My father lives in _____.

Instructors can:

- read the sentences below and ask learners to read the same sentences.
- make two copies of this page. Fill in one copy with information about the learners' families. Give both copies to the learners and ask them to copy the information in the blanks.
- create individualized worksheets similar to this one but include the appropriate number of sisters, brothers, etc.

Learners can:

- read the sentences.
- fill in the blanks.
- refer to the previous pages for correct spelling.
- cut up the page so each sentence stands alone. Put the sentences together similar to before the page was cut.
- cut up each sentence into individual words. Put the words together to make the sentences.

<p>My name is _____.</p> <p>I am _____ years old.</p> <p>I live in _____.</p>	<p>I have _____ sisters.</p> <p>My sister's name is _____.</p> <p>My sister is _____ years old.</p> <p>My sister lives in _____.</p>
<p>I have _____ daughters.</p> <p>My daughter's name is _____.</p> <p>My daughter is _____ years old.</p> <p>My daughter lives in _____.</p>	<p>I have _____ brothers.</p> <p>My brother's name is _____.</p> <p>My brother is _____ years old.</p> <p>My brother lives in _____.</p>
<p>I have _____ wife.</p> <p>My wife's name is _____.</p> <p>My wife is _____ years old.</p> <p>My wife lives in _____.</p>	<p>I have _____ sons.</p> <p>My son's name is _____.</p> <p>My son is _____ years old.</p> <p>My son lives in _____.</p>
<p>I have _____ husband.</p> <p>My husband's name is _____.</p> <p>My husband is _____ years old.</p> <p>My husband lives in _____.</p>	

Instructors can:

- say the sentences and ask learners to say yes or no.
- say a sentence and ask learners to point to the sentence.
- say a sentence and ask learners to repeat the sentence.

Learners can:

- read the sentences.
 - circle yes if the sentence is true and circle no if it is not true.
 - copy the true sentences on a separate paper.
-

I have five children.	yes	no
I have a husband.	yes	no
I have three sons.	yes	no
I have six brothers.	yes	no
I have two sisters.	yes	no
I have one son.	yes	no
I have a wife.	yes	no
I have children	yes	no

Instructors can:

- review the question, "How many ___ do you have?"
- review 'have' and 'has'.
- write the question on a paper or on the chalkboard.
- review the question, "How do you spell ___?"

Learners can:

- in the left column, write the names of people in the class. Ask "How do you spell your name?" Ask each other, "How many ___ do you have?" Write the number in the appropriate column beside their name.
- after asking each other questions, on a separate paper, write about the people in the class (e.g. Lina has two daughters).

How many _____ do you have?

name	children	sisters	brothers

family

mother

father

grandmother

grandfather

grandson

granddaughter

son

daughter

sister

brother

grandparents

grandchildren

wife

husband

HEALTH

What's the matter?



Objective

To identify and describe common health problems.

Goal

To ask and respond to questions about health.

Suggestions

- Save medicine packages for reviewing common health problems.
- Talk with learners about possible rules regarding sickness and school/daycare attendance.
- Talk with learners about the availability of common cold medication.
- Inform learners about the Health Interpreter program. Specially trained health interpreters can accompany newcomers to the doctor and act as interpreters. For more information call (902) 425-5409.
- If learners don't have a family doctor, encourage them to find one.
- Introduce the abbreviation for teaspoon (tsp). Some medicine packages use teaspoon and some use tsp.

Activities

- Visit the clinic.
- Look at learners' health cards. Identify the information on it to your learners. Review when you need your Health Card.
- Collect common medicine packages for the health problems introduced in this chapter (e.g. cough medicine, sore throat medicine, etc.) Look at the labels and identify the words learned in this chapter.

1 tsp	=	5 ml
1 ¹ / ₂ tsp	=	7 ¹ / ₂ ml
2 tsp	=	10 ml
2 ¹ / ₂ tsp	=	12 ¹ / ₂ ml
3 tsp	=	15 ml

Instructors can:

- say a word on this page and ask learners to point to it.
- write the words on this page on separate pieces of paper. Show a word from this page and ask learners to point to the correct picture.
- show a picture from this page and ask learners to point to the word.
- white out the first letter in each word and ask learners to fill in the blanks.

Learners can:

- read the words.
- cut up the pictures and the words, mix them up, and match the words with the pictures.
- cut the words in half, mix them up, and put them back together.

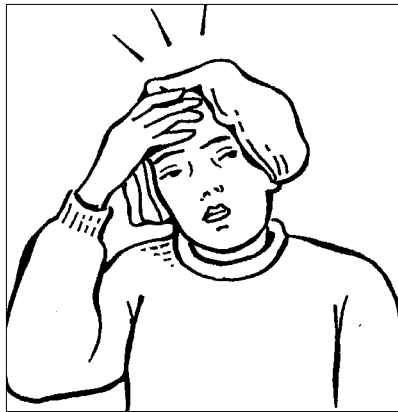

headache



toothache

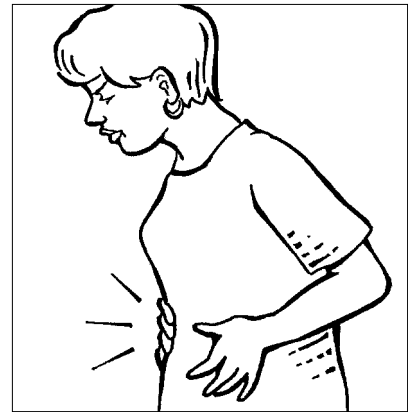

stomachache



backache

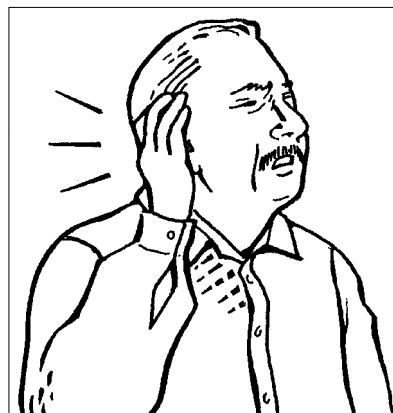

earache

Instructors can:

- say a word and ask learners to point to the word.
- show a word and ask learners to point to it.

Learners can:

- read the words on this page.
 - look at the picture and circle the correct word.
 - cut up the words and match the same words together.
 - cut up the words and the pictures. Match the words with the pictures.
-

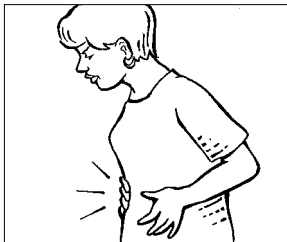

stomachache

backache



toothache

headache



toothache

earache

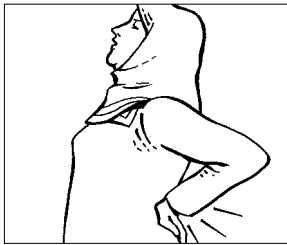

stomachache

backache

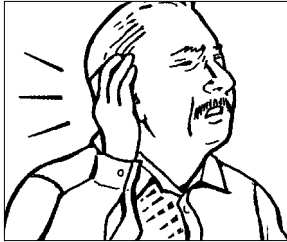

earache

headache

Instructors can:

- introduce the verb 'to have'.
- point to the pictures on this page and ask learners to say the health problem.
- cut up the sentences in to individual words and ask learners to make sentences from the words.
- introduce the question, "What's the matter?" Point to a picture, ask the question and ask learners to respond.

Learners can:

- read the sentences.
- fill in the blanks
- cut up the completed sentences and match them with the picture.
- copy the sentences to a separate paper.
- change the pronoun to refer to a member of your family or someone in class and use 'has'.



I have a _____.

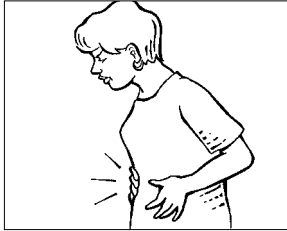

I have a _____.



I have a _____.



I have a _____.



I have an _____.

Instructors can:

- say a word on this page and ask learners to point to it.
- show a word from this page and ask learners to point to it.
- show a picture from this page and ask learners to point to the word.
- white out the first letter in each word and ask learners to fill in the blanks.

Learners can:

- read the words.
- cut up the pictures and the words, mix them up, and match the words with the pictures.
- cut the words in half, mix them up, and put them back together.
- copy the words on a separate paper.

sore throat

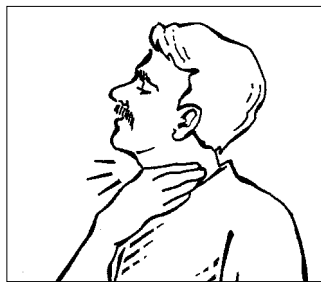

nose bleed

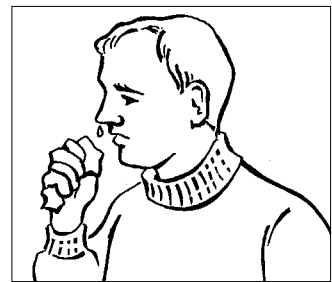

fever



cough



rash



diarrhea



cold

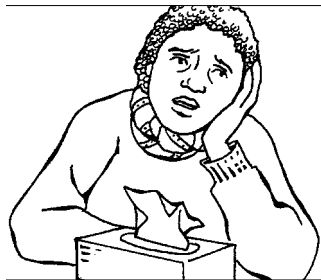

stuffy nose



Instructors can:

- read the words in the left column. Ask learners to repeat the words.
- say a word on this page and ask learners to point to it.

Learners can:

- read the words in the left column.
- circle the correct spelling.



diarrhea

diarhea

diarrhea

diarrhe



sore throat

sore throat

soer thraot

sore troat



cold

coll

cold

cald



rash

rach

rahs

rash



cough

caugh

couhg

cough

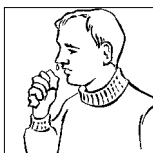

nose bleed

nos bled

nose bleed

no bleed



fever

fever

fevr

fevre



stuffy nose

stufy nose

stuffy nos

stuffy nose

Instructors can:

- review the verb 'to have'.
- point to the pictures on this page and ask learners to say the health problem.
- cut up the sentences in to individual words and ask learners to make sentences from the words.
- review the question, "What's the matter?" Point to a picture, ask the question and ask learners to respond.

Learners can:

- read the sentences.
 - fill in the blanks
 - cut up the completed sentences and match them with the picture.
 - copy the sentences to a separate paper.
 - change the pronoun to a member of their family or someone in class and use 'has'.
-



I have _____.

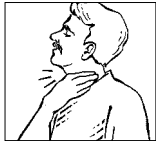

I have a _____.



I have a _____.



I have a _____.



I have a _____.



I have a _____.



I have a _____.



I have a _____.

Instructors can:

- review the health problems on this page.

Learners can:

- cut this paper down the middle. Work in pairs. The person with the blank asks the other person, "What's the matter?" He tells his partner and she writes the problem in the blank.

What's the matter?

1. _____



3. _____

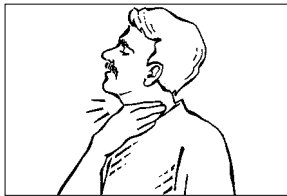

5. _____



What's the matter?



2. _____

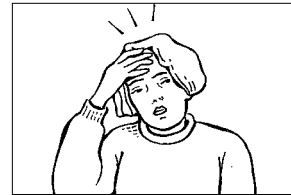

4. _____



6. _____

Instructors can:

- say a word on this page and ask learners to point to it.
- show a word from this page and ask learners to point to it.
- show a picture from this page and ask learners to point to the word.
- white out the first letter in each word and ask learners to fill in the blanks.

Learners can:

- read the words.
- cut up the pictures and the words, mix them up, and match the words with the pictures.
- cut the words in half, mix them up, and put them back together.
- copy the words on a separate paper.



dizzy



constipated



sneezed



cut

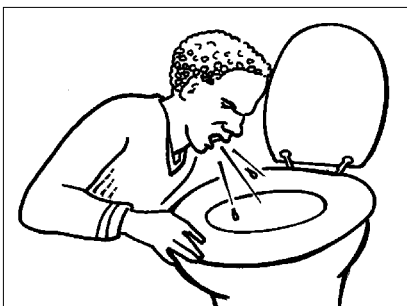

threw up



burnt

Instructors can:

- say the word on the left and ask learners to write the missing letters.
- spell the words and ask learners to fill in the missing letters.
- create a similar worksheet with more or less letters blanked out.
- create a similar worksheet with variations of spellings for each picture as in page ** and ask learners to circle the correct spelling.

Learners can:

- read the words on the left.
- copy the missing letters.
- fold the paper and fill in the missing letters.
- copy the words on a separate paper.
- cut this activity in half after the picture of cut. Work in pairs. Fold the paper. Ask your partner, "How do you spell ___?" Write the missing letters in the blanks.



dizzy

__ izzy

dizz__

di__ zy



constipated

__ onstipated

constipate__

co__ stipated



cut

__ ut

cu__

c__ t



sneezed

__ neezed

snee__ ed

sn__ ezed



burnt

__ urnt

burn__

bur__ t



threw up

__ hrew up

threw u__

th__ ew up

Instructors can:

- point to the pictures on this page and ask learners to say the health problem.
- cut up the sentences in to individual words and ask learners to make sentences from the words.
- review the question, "What's the matter?" Point to a picture, ask the question and ask learners to respond.

Learners can:

- read the sentences.
 - fill in the blanks
 - cut up the completed sentences and match them with the picture.
 - copy the sentences to a separate paper.
 - change the pronoun to a member of their family or someone in class.
-



I am _____.



I am _____.

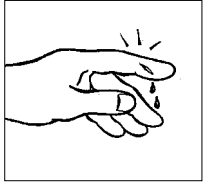

I _____ my finger.

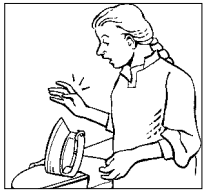

I _____ my hand.



I _____.



I _____.

Instructors can:

- introduce the pictures and words below.
- point to a word and ask learners to say the word.
- say a word and ask learners to point to the word.
- write the words on separate pieces of paper. Show learners a word and ask them to point to it on their paper.

Learners can:

- read the words on this page.
- copy the words on a separate paper.
- fill in the blanks with the missing letters.
- copy the words on the blanks below.
- cut up the pictures and the words and match them.

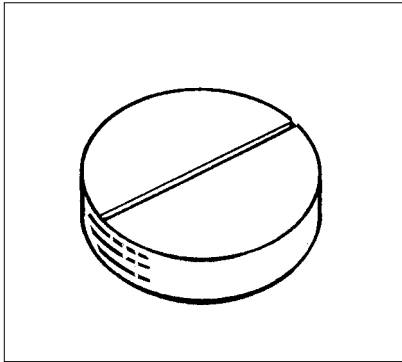

tablet

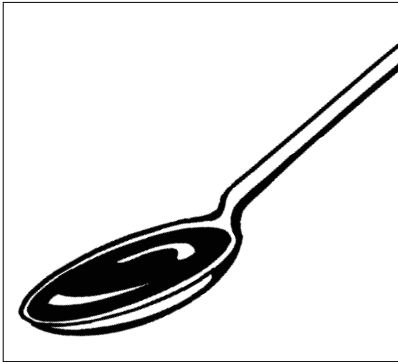

teaspoon

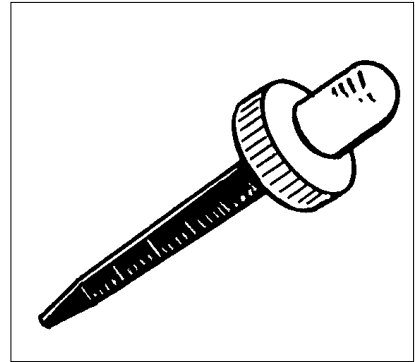

dropperful

tablet

__ablet

table__

ta__let

teaspoon

__easpoon__

teaspoon__

tea__poon

dropperful

__ropperful

dropperfu__

droppe__ful

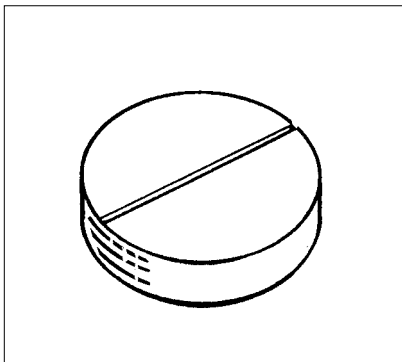

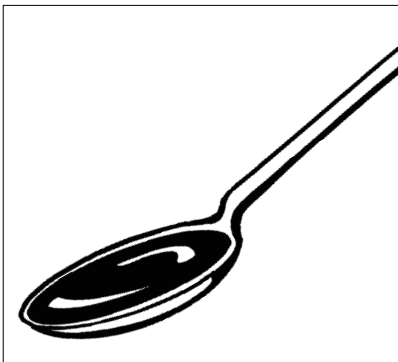

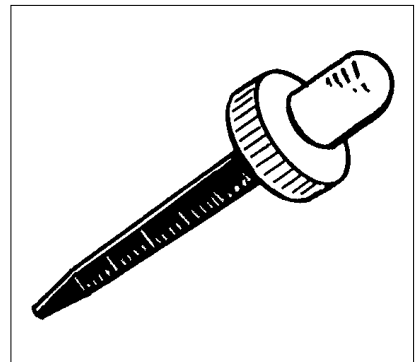









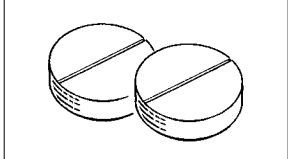
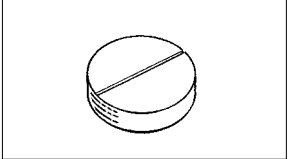

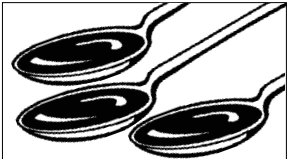

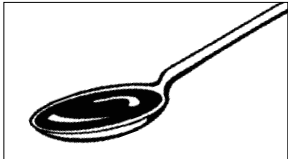
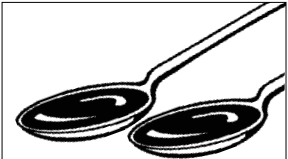
Instructors can:

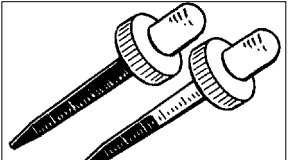
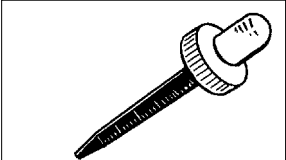
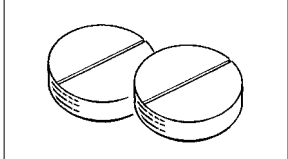
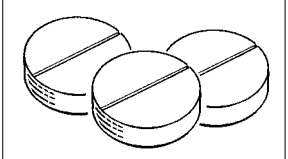
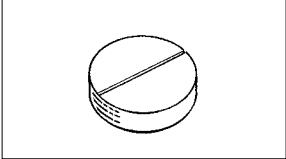
- read a phrase on this page and ask learners to point to it on their paper.
- read a phrase on this page and ask learners to point to the picture.
- cut up the phrases. Say the phrases and ask learners to put them in order.

Learners can:

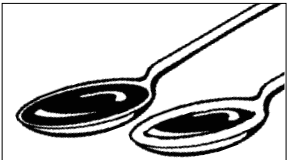
- read the words on this page.
- read the words and circle the correct picture.

take 1 tablet			
take 1 teaspoon			
take 2 teaspoons			
take 1 dropperful			
take 2 tablets			
take 2 dropperfuls			
take 1 1/2 teaspoons			

Instructors can:

- read a phrase on this page and ask learners to point to it on their paper.
- read a phrase on this page and ask learners to point to the picture.
- cut up the phrases. Say the phrases and ask learners to put them in order.

Learners can:

- read the words on this page.
- read the words and circle the correct picture.

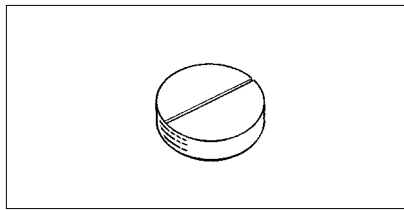

tablet

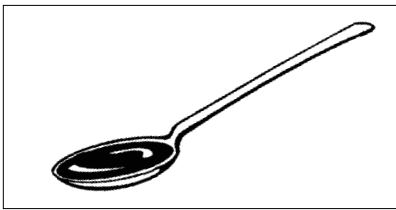

teaspoon

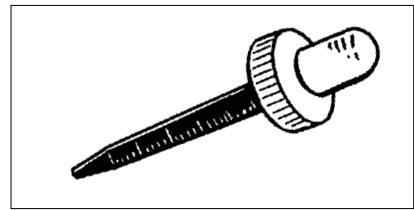

dropperful

take 1 tablet

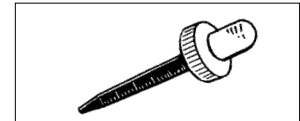
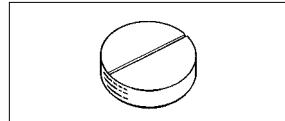

take 1 teaspoon

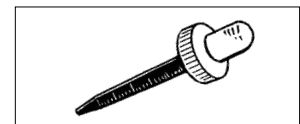
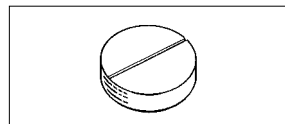

take 2 teaspoons

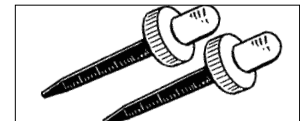
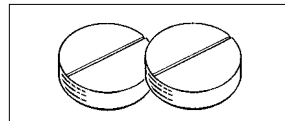
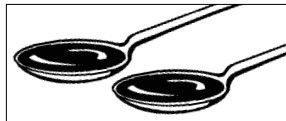

take 1 dropperful

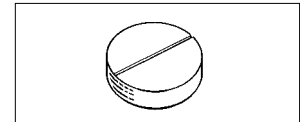
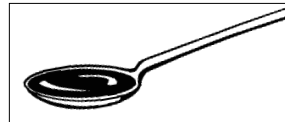
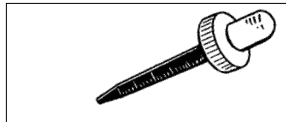

take 2 tablets

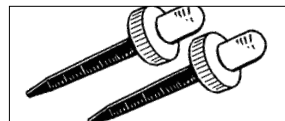
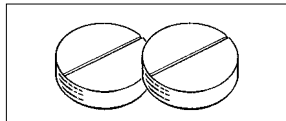

take 2 dropperfuls

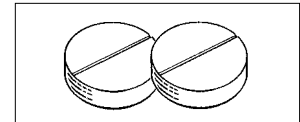
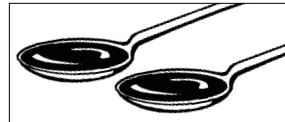
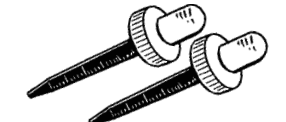

take 1 1/2 teaspoons

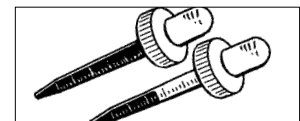
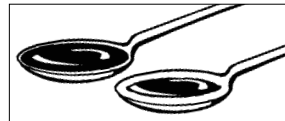
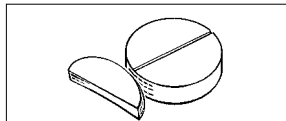

Instructors can:

- review the word age.
- teach the words dosage, and weight.
- say a dosage amount and ask learners to circle it.
- say an age and ask learners to point to it.
- copy this page and white out some of the information. Give learners a copy of the page with missing information and a page with all the information. Ask learners to fill in the blanks.

Learners can:

- read the information on this page.
- have two copies of this page. Cut up the information on one page. Match the cut-up words with the uncut page.
- cut up the dosage words with the dosage pictures. Match the picture with the correct dosage.

age

dosage

Under 2 years

ask your doctor

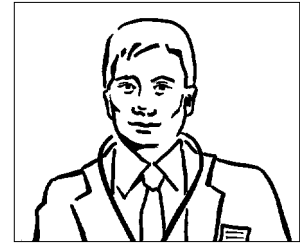

2 - 3 years

1 teaspoon

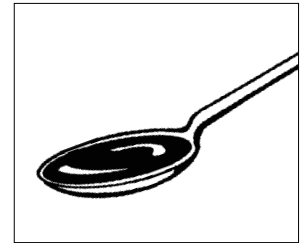

4 - 5 years

1 1/2 teaspoons

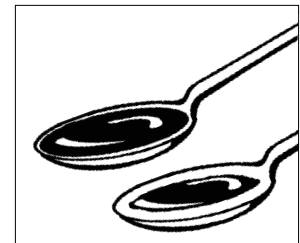



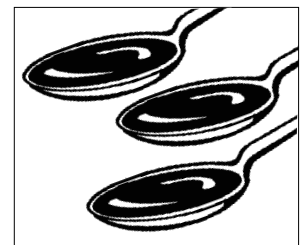

9 - 11 years

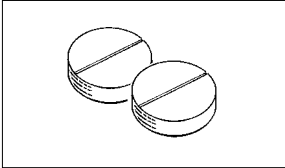
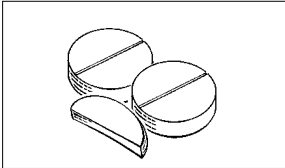
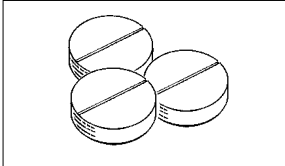
3 teaspoons

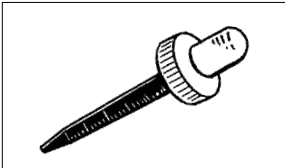
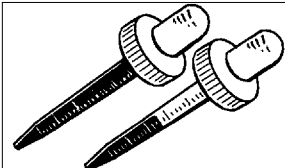
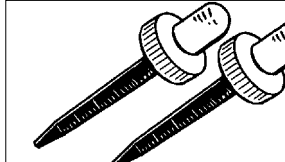

age	dosage	
6-8 years	2 tablets	
9-10 years	2½ tablets	
11 years	3 tablets	

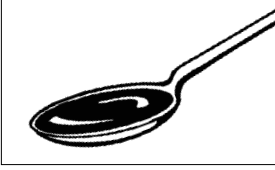
age	dosage	
0 - 3 months	ask your doctor	
4 - 11 months	1 dropperful	
12 - 23 months	1½ dropperfuls	
2 - 3 years	2 dropperfuls	





age	weight	dosage	
Under 1 year	under 18 lb under 8 kg	ask your doctor	
1 - 5 years	18 - 48 lb 8 - 22 kg	1 teaspoon	
6 - 11 years	48 - 95 lb 22 - 44 kg	2 teaspoons	

Instructors can:

- say a phrase and ask learners to point to it.
- write the words on separate pieces of paper. Show a phrase and ask learners to point to the same one on their paper.

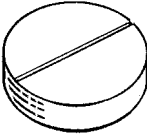
Learners can:

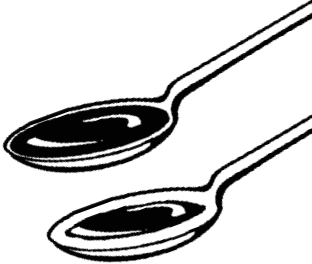
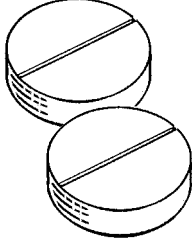
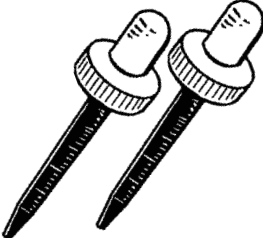
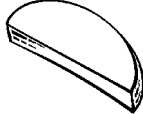
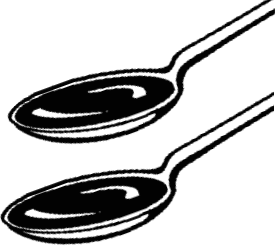
- cut up this page and match the dosage with the picture.

take 1 tablet	take 1 teaspoon		
take 1 1/2 teaspoons	take 2 tablets		
take 2 dropperfuls	take 1/2 tablet		
take 2 teaspoons	take 1 dropperful		

headache

toothache

stomachache

backache

earache

sore throat

nose bleed

fever

cough

rash

diarrhea

a cold

stuffy nose

dizzy

constipated

sneezed

cut

threw up

burnt

tablet

teaspoon

dropperful

doctor

age

dosage	weight

FOOD

Excuse me, do you have any oranges?

Objective

To identify common food.

Goals

- To learn the names of common food.
- To express likes and dislikes with food.
- To inquire about food in a grocery store.

Suggestions

- Focus on food learners are familiar with.
- Don't teach all the words at the same time.
- Teach words in groupings (e.g. fruit, vegetables, etc.)
- The activities in this chapter refer to kilograms and not pounds. If your learners are more familiar with pounds convert the prices to pounds. Learners will come in contact with pounds as some prices are listed only in pounds (e.g. 5 lb. bag of onions, carrots or potatoes).
- Teach abbreviations for 'kilogram', 'pound' (if you introduce it), and 'each'. Show examples of these from flyers or point them out during your trip to the grocery store.
- Collect the grocery store flyers every week. Review language that learners are familiar with. Look at the flyers weekly to reinforce learned vocabulary.
- Collect pictures of fruit and vegetables from seed catalogues, flyers and magazines.
- There are cultural differences surrounding food and offering food. It is good to explore these differences.

Activities

- Visit a grocery store. Give learners a copy of a page in this chapter with illustrations on it. Ask learners to write the price beside the picture or write the name of the item beside the picture. During your visit to the grocery store learners can also write names of other food items that are not included in this chapter.
- Make customized information gap activities by using the current local grocery store flyers and prices. See page 13.18 for an example of an information gap.
- **Food Cards** – Have two sets of food cards. You can make these cards using recipe cards and the illustrations in this chapter. Pre-teach the question, "Do you have any bananas?" and "Yes, here you are" or "No, sorry I don't." Deal a few cards to each player. Put the remaining cards upside down in the middle of the table. One person starts by choosing a card in her hand and asking if another person has that card. She asks, "Do you have a ___?" If the answer is "yes", the person gives the asker the card and she puts it together with her card on the table. If the answer is "no", the asker picks up a card from the pile of cards in the middle of the table. The idea is to get pairs of food cards. This reinforces the common question, "Do you have a ___?" and reinforces common food names.

Instructors can:

- read the words on this page and ask learners to point to them.
- write the words on this page on separate pieces of paper. Show the words and ask learners to point to the correct picture.
- introduce singular and plural forms.

Learners can:

- read the words on this page.
- write these words on a separate paper.
- cut up the words and the pictures and match them.
- cut the words in half. Mix them up and put the words back together.

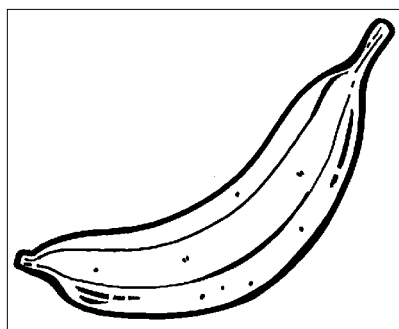

banana

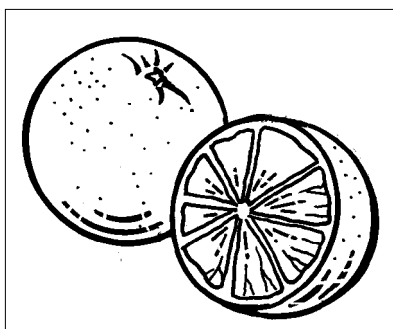

orange

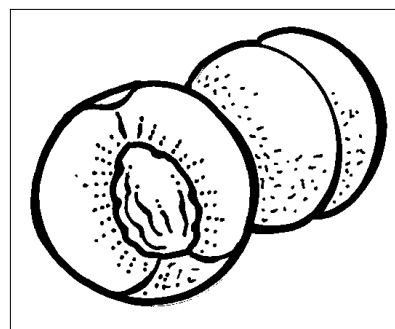

peach

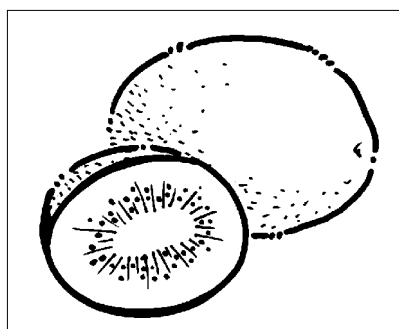

kiwi

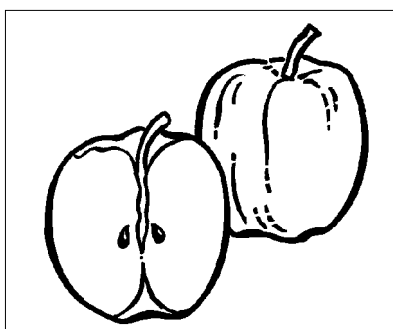

apple

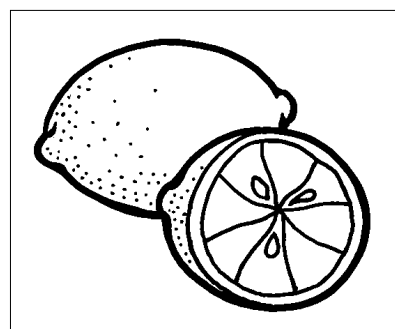

lemon

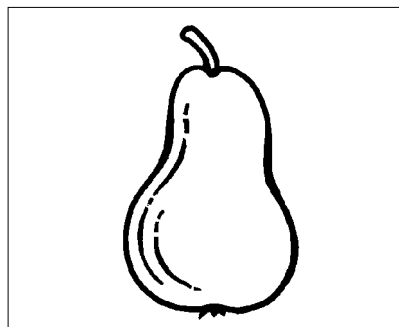

pear

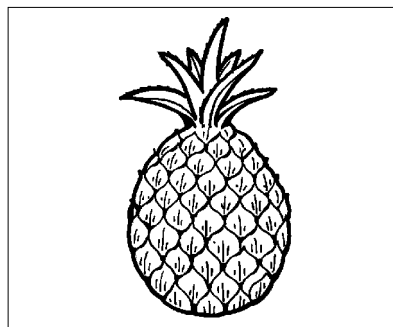

pineapple

Instructors can:

- review the question, “How do you spell ___?”
- ask learners, “How do you spell ___?” Learners respond by spelling the words.
- say a word and ask learners to point to it.
- write the words on this page on separate pieces of paper. Show learners a word and ask them to point to the same word on their page.

Learners can:

- fill in the blanks with the correct letter.
- work in pairs. Fold the paper so one learner has the completed word and the other has the words with blanks. The learner with the picture and the complete words says the name of the fruit. The other learner asks, “How do you spell that?” The learner with the completed words spells the word as the other learner fills in the blanks.
- after filling in the blanks, learners can cut up the page and match the words with the pictures.

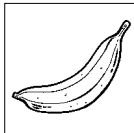

banana

__anana

banan__

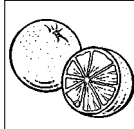

orange

__range

oran__e

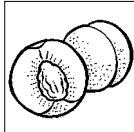

peach

__each

pea__ _

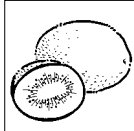

kiwi

__iwi

ki__i

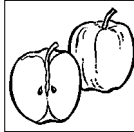

apple

__pple

app__e

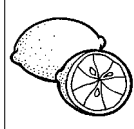

lemon

__emon

lemo__

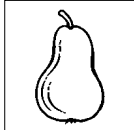

pear

__ear

pea__

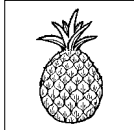

pineapple

__ineapple

pineapp__e

Instructors can:

- say words on this page and ask learners to point to them.
- say the words for the pictures and ask learners to circle the words.

Learners can:

- read the words on this page.
- circle the correct word.
- cut up the pictures and the words. Match the words with the pictures.
- cut up the words. Mix them up and group the same words together.

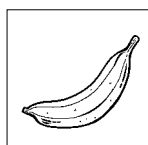

banana

pear

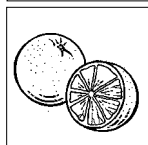

orange

pineapple

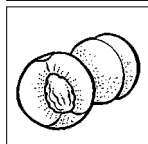

lemon

peach

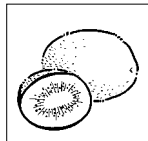

kiwi

apple

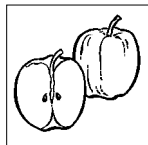

orange

apple

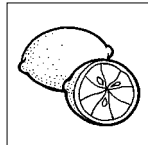

lemon

banana

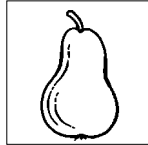

kiwi

pear

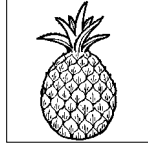

pineapple

peach

Instructors can:

- review the question, “How do you spell ___?”
- say the words on this page and ask learners to circle them.
- say the words on this page and ask learners to spell them.

Learners can:

- read the words on this page.
 - copy the words in the blanks.
 - work in pairs. Learner A covers the words and asks, “How do you spell ___?” Learner B spells the word. Learner A listens and writes the word in the blank.
-

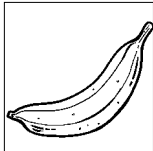

banana

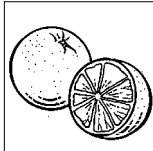

orange

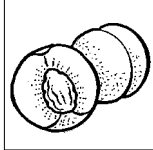

peach

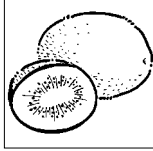

kiwi

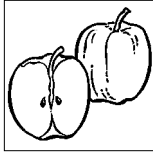

apple

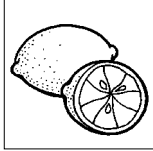

lemon

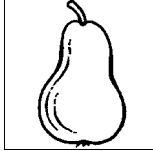

pear

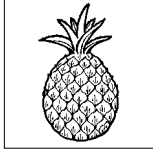

pineapple

Instructors can:

- read the words on this page and ask learners to point to them.
- write the words on this page on separate pieces of paper. Show the words and ask learners to point to the correct picture.
- Introduce/review singular and plural forms.

Learners can:

- read the words on this page.
- write these words on a separate paper.
- cut up the words and the pictures and match them.

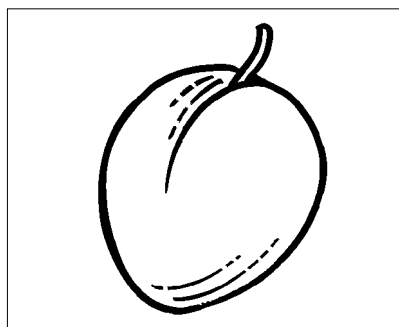

plum

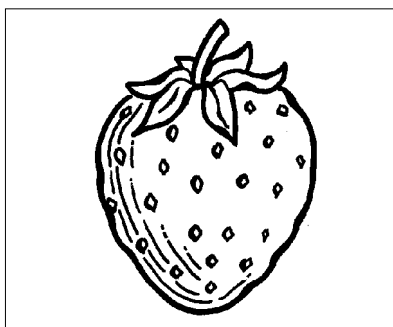

strawberry

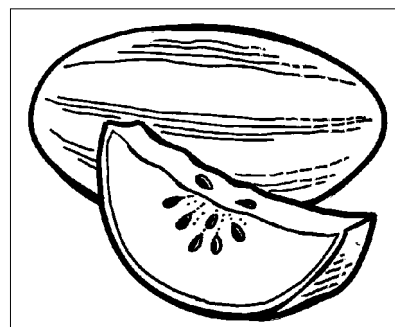

watermelon

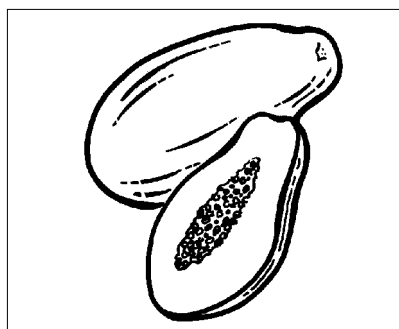

mango

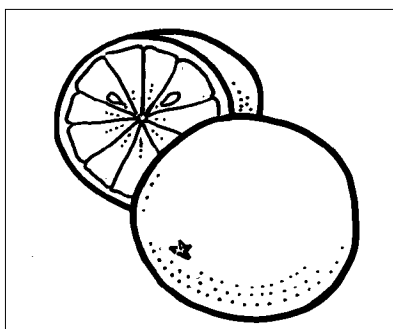

grapefruit

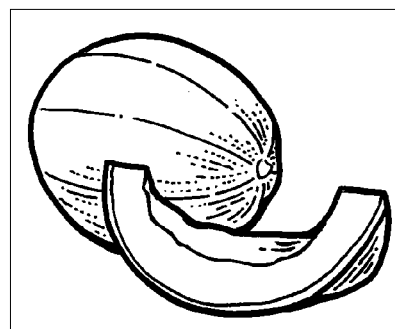

cantaloupe

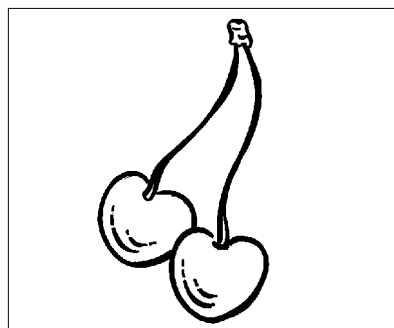

cherries

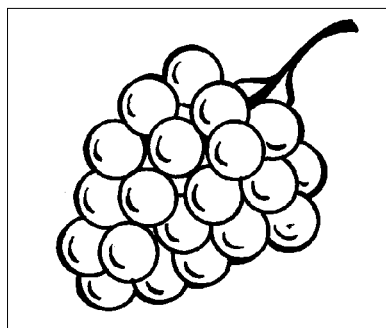

grapes

Instructors can:

- review the question, "How do you spell ___?"
- ask learners, "How do you spell ___?" Learners respond by spelling the words.
- say a word and ask learners to point to it.
- write the words on this page on separate pieces of paper. Show learners a word and ask them to point to the same word on their page.

Learners can:

- fill in the blanks with the correct letter.
- work in pairs. Fold the paper so one learner has the completed word and the other has the words with blanks. The learner with the picture and the complete words says the name of the fruit. The other learner asks, "How do you spell that?" The learner with the completed words spells the word as the other learner fills in the blanks.
- after filling in the blanks, learners can cut up the page and match the words with the pictures.

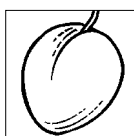

plum

__lum

plu__

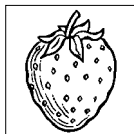

strawberry

__trawberry

strawberr__

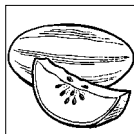

watermelon

__atermelon

watermelo__

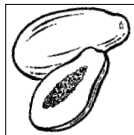

mango

__ango

mang__

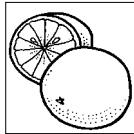

grapefruit

__rapefruit

grapefrui__

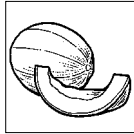

cantaloupe

__antaloupe

cantalou__e

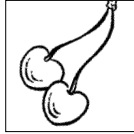

cherries

__ __erries

cherrie__

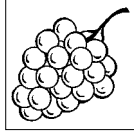

grapes

__rapes

grape__

Instructors can:

- read the words in the left column. Ask learners to repeat the words.
- say a word on this page and ask learners to point to it.

Learners can:

- read the words in the left column.
- circle the correct spelling.

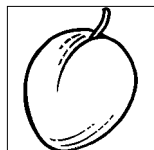

plum

plum

pulm

plun

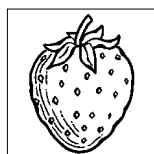

strawberry

strawbery

strawberr

strawberry

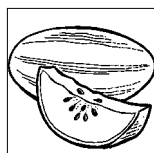

watermelon

melonwater

watermelon

watermeln

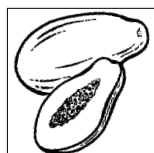

mango

monga

mamgo

mango

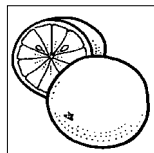

grapefruit

grapefruit

grapefriut

graepfruit

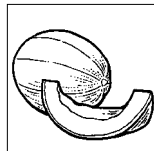

cantaloupe

cantaloup

cantaloupe

cantaluope

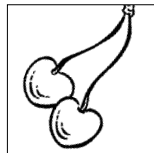

cherries

cheries

cherrie

cherries

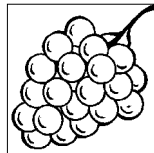

grapes

graeps

grappe

grapes

Instructors can:

- look at the pictures. Ask learners to say the words.
- say a word on this page and ask learners to point to it.
- write these words on separate pieces of paper. Show a word on this page and ask learners to count how many are on the page.

Learners can:

- read the words beside the pictures.
- circle the word, on each line, that is the same as the picture.
- cut up the words and group the same words together.

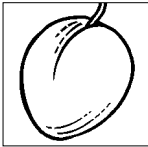

plum

grapes

strawberry

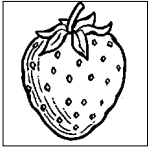

strawberry

cherries

mango

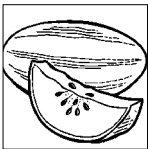

cantaloupe

grapes

watermelon



mango

grapefruit

cherries

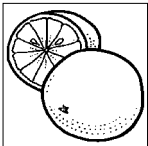

strawberry

plum

grapefruit

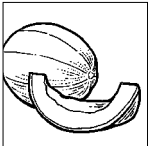

cantaloupe

watermelon

grapes

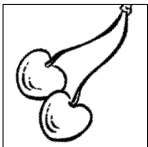

mango

cherries

plum

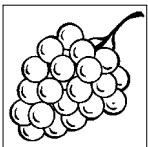

cherries

strawberry

grapes

Instructors can:

- teach the words 'each', and 'kilogram'.
- review numbers and prices.
- introduce/review the question, "How much are ___?"
- say a price on this page and ask learners to point to it.
- introduce the abbreviation 'kg'.
- get more accurate prices from a local store.
- say a price on this page and ask learners to write the price on a separate paper.
- say the name of a fruit on this page and ask learners to point to it.

Learners can:

- work in pairs. Cut this paper down the center and each learner takes one part. The learner with the blank beside the picture asks his partner, "How much are ___?" The partner says the price on her paper. The partner writes the price in the blank.

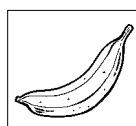

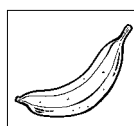

\$1.52 kg

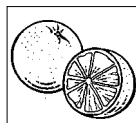

\$3.73 kg

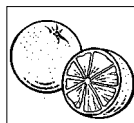

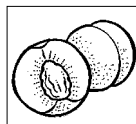

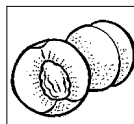

\$3.95 kg

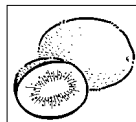

.25 each

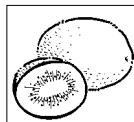

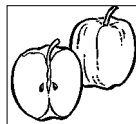

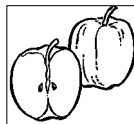

\$1.96 kg

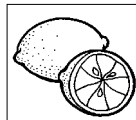

.59 each

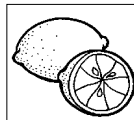

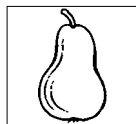

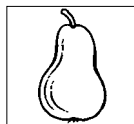

\$3.95 kg

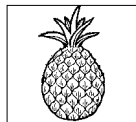

\$3.99 each

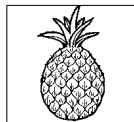

Instructors can:

- teach the question “Would you like a ___?” Also teach the responses, “Yes, thank you” and “No, thank you.”
- provide real fruit or vegetables to practice offering food to each other. If real objects are not available, cut out the pictures from this page.
- substitute other food vocabulary for the pictures on this page.

Learners can:

- fill in the blank with the word for the picture.
- refer to the previous pages for help with spelling.
- read the sentences to people in the class.

Would you like a _____?

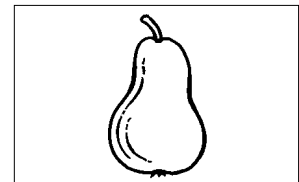

Would you like a _____?

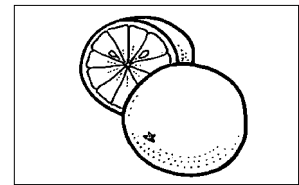

Would you like a _____?

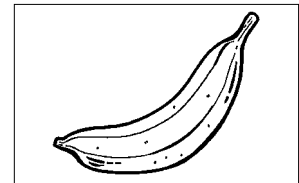

Would you like a _____?

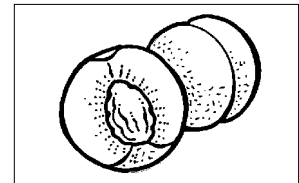

Would you like a _____?

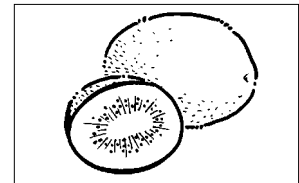

Would you like a _____?



Instructors can:

- read the words on this page and ask learners to point to them.
- write the words on this page on separate pieces of paper. Show the words and ask learners to point to the correct picture.
- review singular and plural forms.

Learners can:

- read the words on this page.
- write these words on a separate paper.
- cut up the words and the pictures and match them.
- cut out the words and put all the words together that have the same first letter.

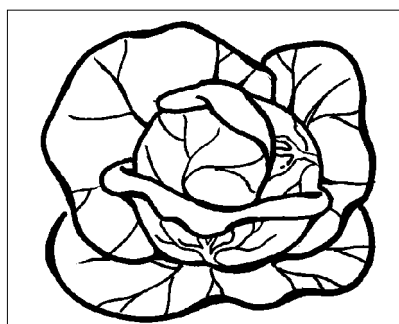

cabbage

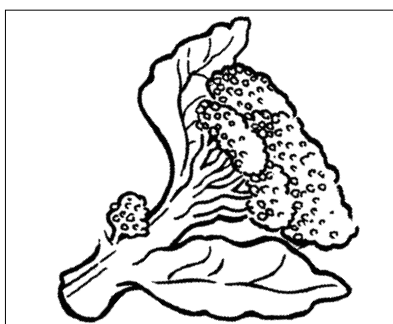

broccoli

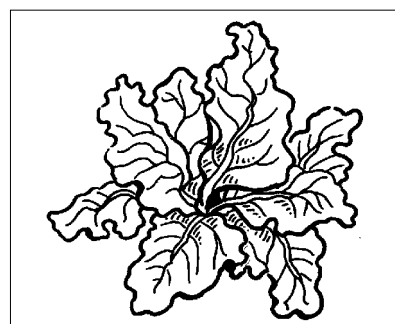

spinach

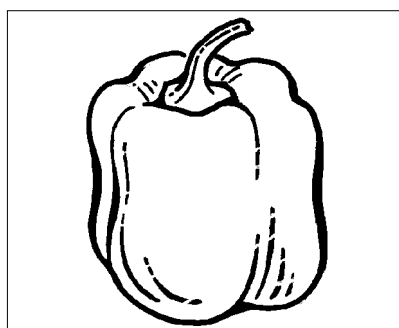

green pepper

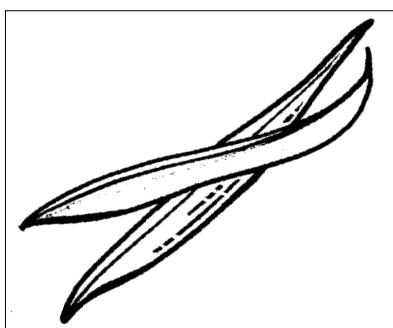

beans

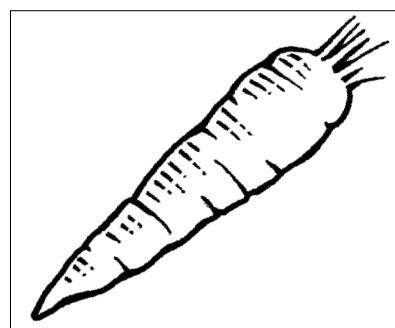

carrot

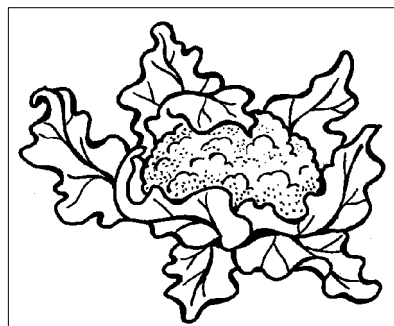

cauliflower

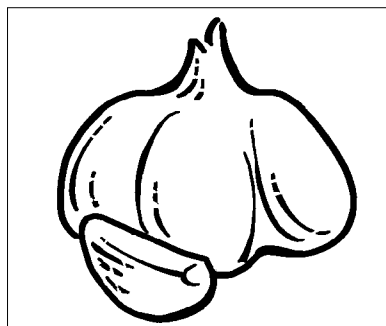

garlic

Instructors can:

- say a word on this page and ask learners to point to it.
- say a word on this page and ask learners to write the word in the blank.
- write these words on separate pieces of paper. Show learners a word from this page and ask them to point to the same word.
- fill in some of the blanks to make the activity easier.

Learners can:

- look at the pictures and read the words beside the pictures.
- copy the words into the blanks.
- fold the paper so the words are hidden and write the words in the blanks.
- work in pairs. Cut the words off this paper. Cut the list of words in half. Ask her partner, "How do you spell ___?" Her partner spells the word and she writes it in the blank.

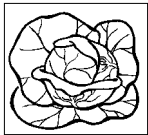

cabbage

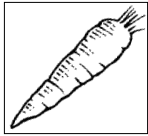

carrot

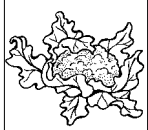

cauliflower



broccoli



beans



spinach

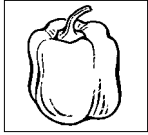

green pepper

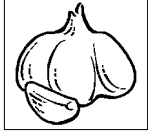

garlic

Instructors can:

- look at the pictures. Ask learners to say the words.
- say a word on this page and ask learners to point to it.
- write these words on separate pieces of paper. Show a word on this page and ask learners to count how many are on the page.

Learners can:

- read the words beside the pictures.
- circle the word, on each line, that is the same as the picture.
- cut out all the words and pictures. Match the words with the pictures.
- cut out all the words. Put all the same words together.

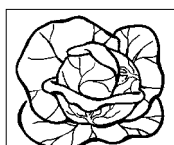

broccoli

cabbage

garlic

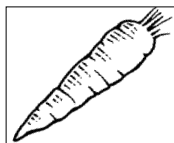

carrot

beans

spinach

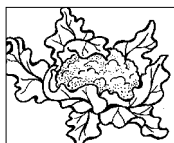

green pepper

broccoli

cauliflower



broccoli

beans

garlic



spinach

beans

carrot

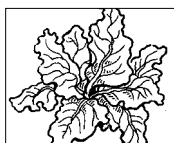

cauliflower

spinach

green pepper

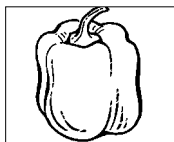

garlic

green pepper

carrot

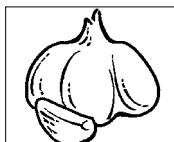

garlic

broccoli

beans

Instructors can:

- say the words on this page and ask learners to repeat the words.
- say the word and ask learners to circle the correct picture.
- say the word and ask learners to circle all the pictures of that word.

Learners can:

- read the words on this page.
- read the word and circle the correct picture.
- write the words on a separate paper.

cabbage

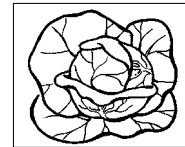
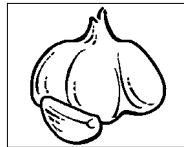

carrot

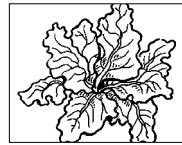
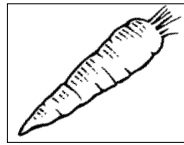

cauliflower

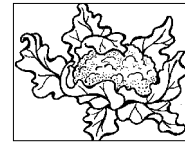
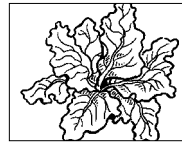
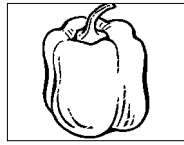

broccoli

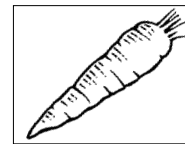
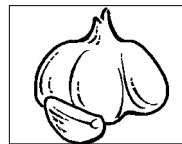
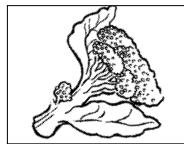

beans

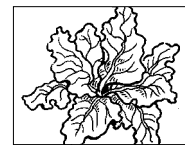
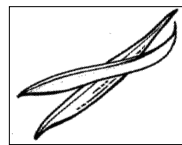
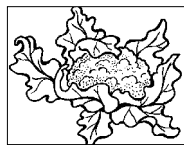

spinach

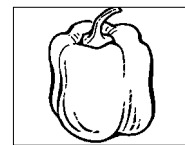
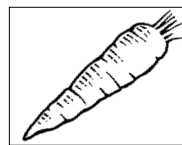
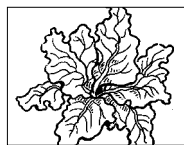

green pepper

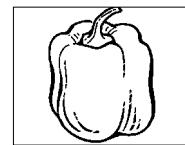
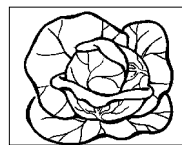
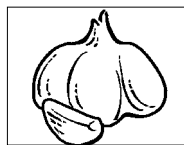

garlic

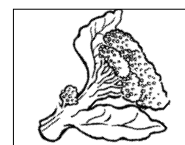
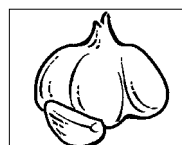
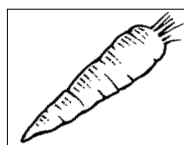

Instructors can:

- read the words on this page and ask learners to point to them.
- write the words on this page on separate pieces of paper. Show the words and ask learners to point to the correct picture.
- review/introduce singular and plural forms.

Learners can:

- read the words on this page.
- write these words on a separate paper.
- cut up the words and the pictures and match them.
- cut the words in half. Mix them up and put the words back together.

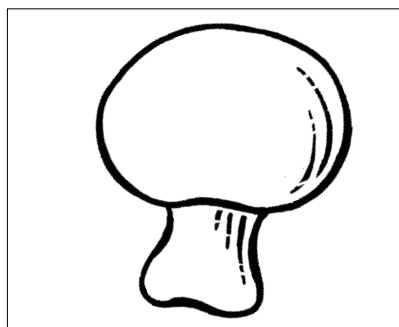

mushroom

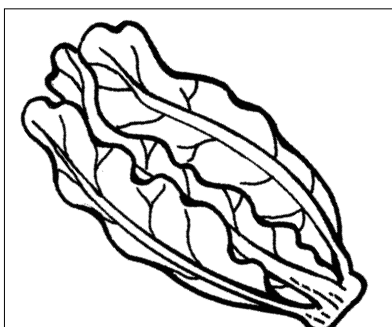

lettuce

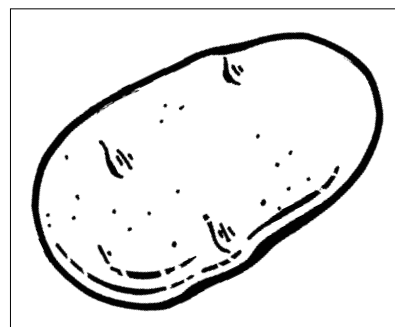

potato

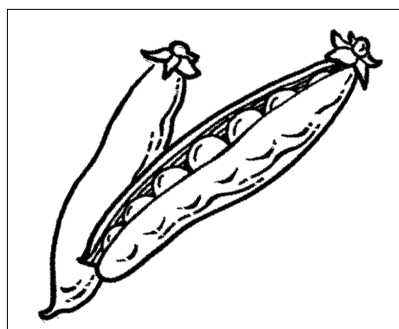

peas

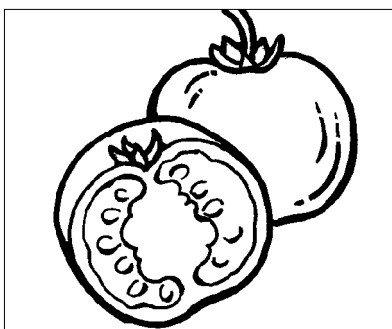

tomato

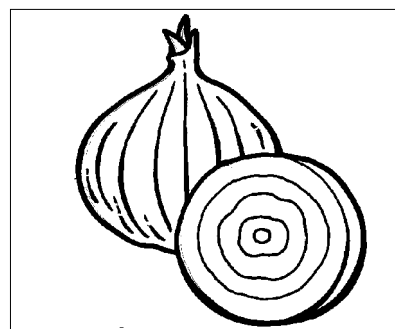

onion

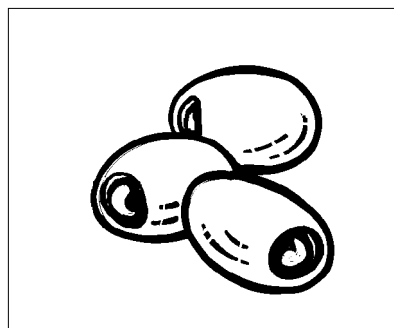

olives

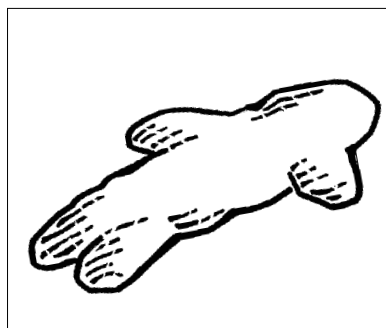

ginger

Instructors can:

- say a word and ask learners to circle it.
- write these words on separate pieces of paper.
Show a word on this page and ask learners to count how many are on the page.
- show a word and ask learners to circle that word on the page.
- say the first word in each line and ask learners to repeat the word.

Learners can:

- read the first word on each line and circle the word that is the same.
- cut up the words and group the same words together.
- copy the words on to a separate paper.

mushroom

ginger

mushroom

peas

lettuce

lettuce

olives

potato

potato

onion

tomato

potato

peas

peas

lettuce

mushroom

tomato

tomato

ginger

olives

onion

tomato

potato

onion

olives

peas

olives

mushroom

ginger

ginger

lettuce

peas

Instructors can:

- say words on this page and ask learners to point to them.
- say the words for each picture and ask learners to circle the correct words.

Learners can:

- read the words on this page.
- circle the correct word.
- cut up the pictures and the words. Match the words with the pictures.
- cut up the words. Put the same words together.

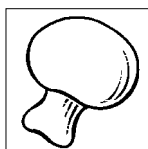

mushroom

ginger



olives

lettuce

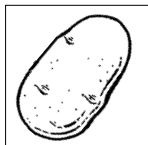

onion

potato

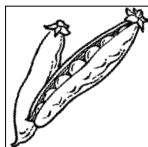

peas

tomato

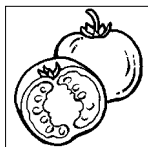

tomato

mushroom

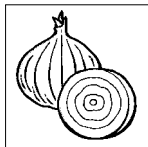

onion

lettuce

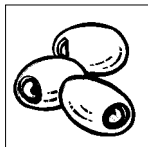

olives

mushroom

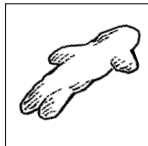

potato

ginger

Instructors can:

- teach/review the words each, and kilogram.
- review numbers and prices.
- review the question, "How much are ___?" Say a price on this page and ask learners to point to it.
- introduce abbreviation 'kg'.
- get more accurate prices from a local store.
- say a price on this page and ask learners to write the price on a separate paper.
- say the name of a fruit on this page and ask learners to point to it.

Learners can:

- work in pairs. Cut this paper down the center and each learner takes one part. The learner with the blank beside the picture asks his partner, "How much are ___?" The partner says the price on her paper. The partner writes the price in the blank.

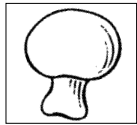



.99 each

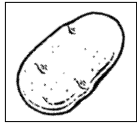

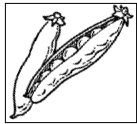

\$7.18 kg

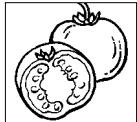



\$1.60 kg

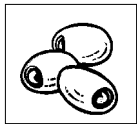



\$4.39 kg

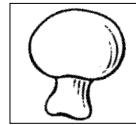

\$6.59 kg



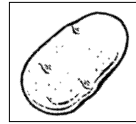

\$1.30 kg

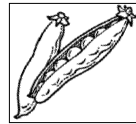

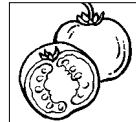

\$2.18 kg

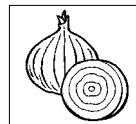

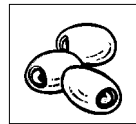

\$5.99 kg

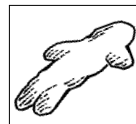

Instructors can:

- look at the pictures and say the words. Ask learners to write the first letters in the blanks.
- say a word on this page and ask learners to point to the picture.
- create similar worksheets and white out different letters.

Learners can:

- look at the picture and say the word.
- fill in the blank with the missing letter. Refer to page ___ for help with spelling.
- work in pairs. One learner has this page and the other learner has page 13.11 and 13.15. Practice asking each other, "How do you spell 'onion'?" Learners write the missing letters in the blanks.
- after the blanks are filled in, copy these words on a separate page.

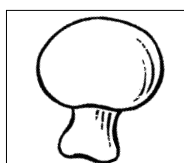

__ushroom

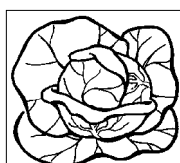

__abbage



__ettuce

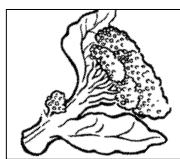

__roccoli

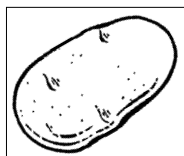

__otato

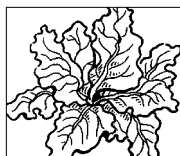

__pinach

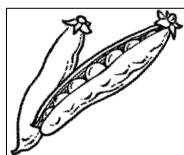

__eas

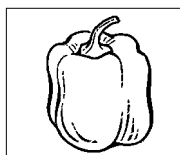

__reen __epper

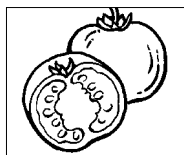

__omato



__eans

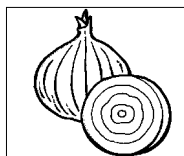

__nion

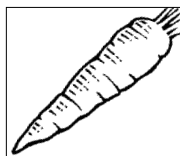

__arrot



__inger

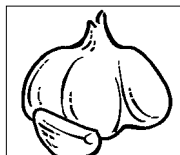

__arlic

Instructors can:

- read the words on this page and ask learners to point to them.
- write the words on this page on separate pieces of paper. Show the words and ask learners to point to the correct picture.

Learners can:

- read the words on this page.
 - write these words on a separate paper.
 - cut up the words and the pictures and match them.
 - cut two words in half. Mix them up and put them together. Then add another cut up word, mix them up, etc.
-

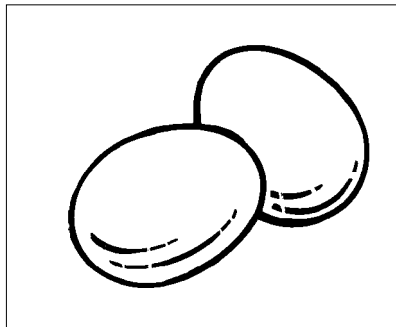

eggs

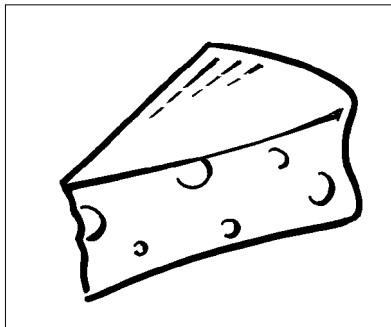

cheese

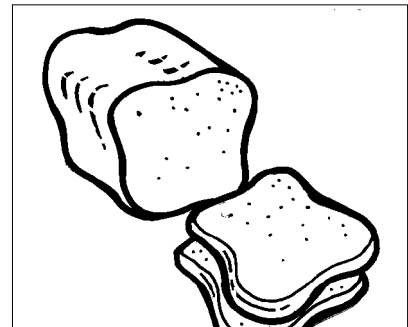

bread

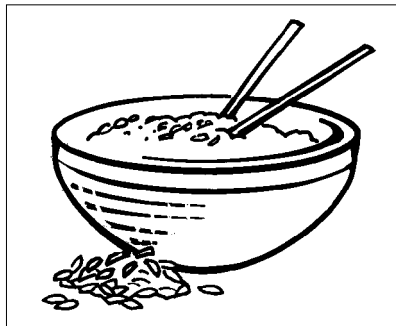

rice

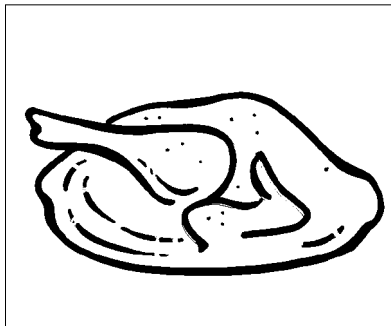

chicken

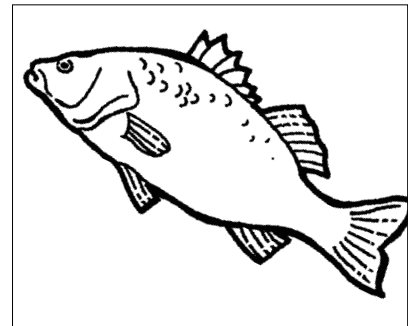

fish

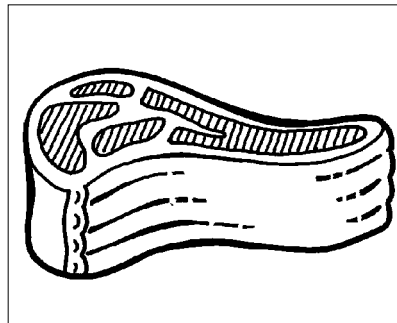

beef

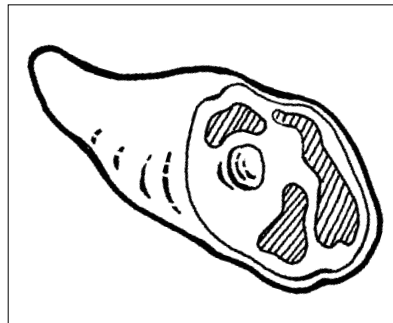

pork

Instructors can:

- read the words in the left column. Ask learners to repeat the words.
- say a word on this page and ask learners to point to it.

Learners can:

- read the words in the left column.
- circle the correct spelling.

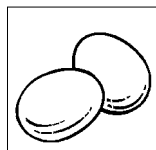

eggs

egs

eggs

eegs

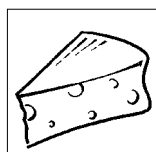

cheese

chees

chese

cheese

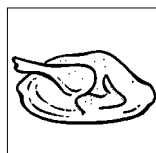

chicken

chicken

chicke

chickem

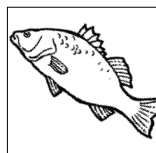

fish

fich

hsif

fish

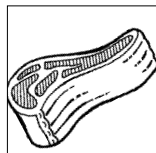

beef

beef

befe

beefe

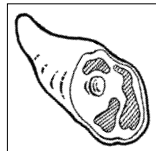

pork

park

pork

pok

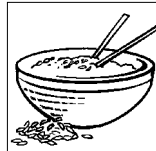

rice

rise

riec

rice

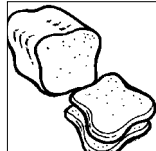

bread

bred

bread

braed

Instructors can:

- review the question, "How do you spell ___?"
- ask learners, "How do you spell ___?" Learners respond by spelling the words.
- say a word and ask learners to point to it.
- write the words on this page on separate pieces of paper. Show learners a word and ask them to point to the same word on their page.

Learners can:

- fill in the blanks with the correct letter.
- work in pairs. Fold the paper so one learner has the completed word and the other has the words with blanks. The learner with the picture and the complete words says the name of the fruit. The other learner asks, "How do you spell ___?" The learner with the completed words spells the word as the other learner fills in the blanks.
- after filling in the blanks, learners can cut up the page and match the words with the pictures

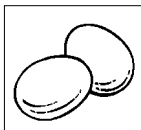

eggs

__ggs

egg__



cheese

__ __eese

chee__e



chicken

__ __icken

chicke__

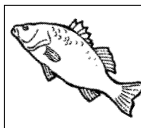

fish

__ish

fi__ __

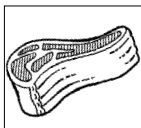

beef

__eef

bee__

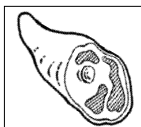

pork

__ork

por__

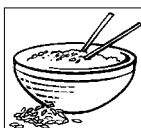

rice

__ice

ri__e

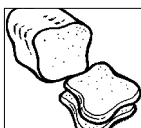

bread

__read

brea__

Instructors can:

- say words on this page and ask learners to point to them.
- say the words for the pictures and ask learners to circle the words.

Learners can:

- read the words on this page.
- look at the picture. Read the two words beside the picture. Circle the correct word.
- cut up the pictures and the words. Match the words with the pictures.
- cut up the words. Put the same words together.

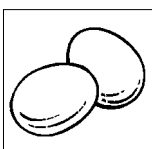

eggs

rice

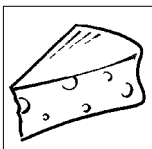

cheese

fish

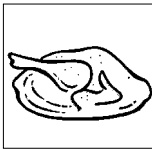

chicken

bread



pork

fish

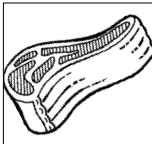

beef

eggs

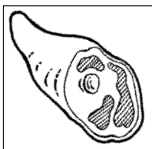

cheese

pork

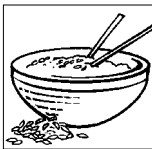

fish

rice

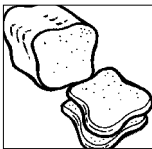

bread

chicken

Instructors can:

- teach the verb 'to like'.
- teach the negative form of 'to like'.
- show a picture of food. Ask learners to say whether they like or don't like this food.
- write some food words on a separate paper. Show a word and ask learners to say whether they like or don't like this food.

Learner can:

- write food words in the blanks.
 - read the sentences to a partner.
 - change the subject of the sentence (e.g., my daughter, my wife, etc.)
 - practice the sentences substituting names of people in the class.
 - refer to previous pages for help with spelling.
 - copy the sentences to a separate paper.
-



I like _____.

I don't like _____.

I like _____.

I don't like _____.

I like _____.

I don't like _____.

I like _____.

I don't like _____.

I like _____.

I don't like _____.

Instructors can:

- teach the question “Do you have any ___?” Also teach the responses, “Yes, here you are” or “Yes, over there” and “No, sorry I/we don’t.”
- write the appropriate responses on the chalkboard so learners can refer to it when needed.
- distribute several pictures of food that learners are familiar with. Practice asking and responding to the question, “Do you have any ___?”
- substitute the pictures on this page with other food vocabulary.

Learners can:

- fill in the blank with the word of the picture.
- refer to the previous pages for help with spelling.
- read the sentences to people in the class.



Excuse me, do you have any _____?

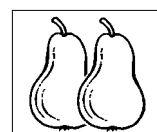

Excuse me, do you have any _____?

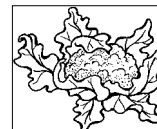



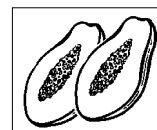



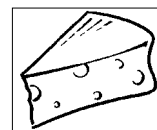

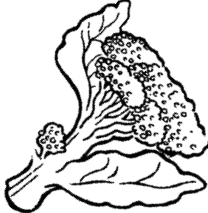
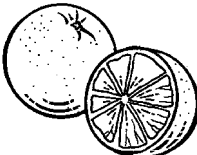
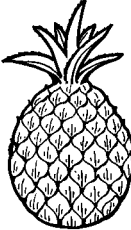
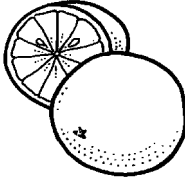
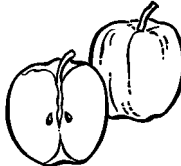
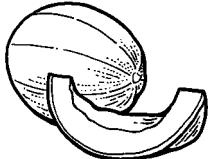

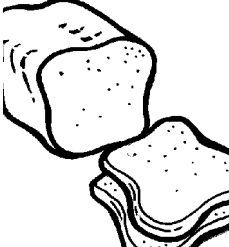
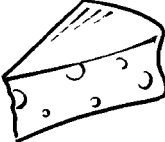



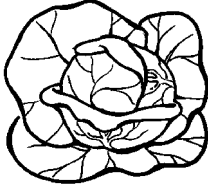

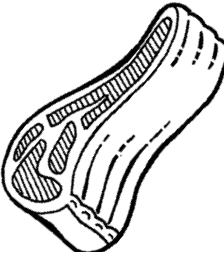
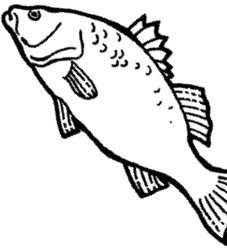
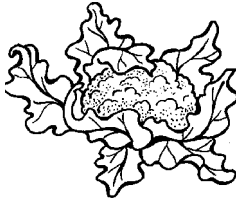
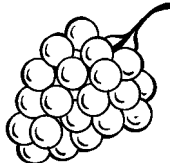

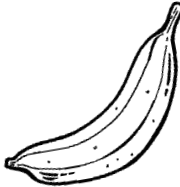



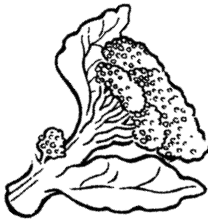

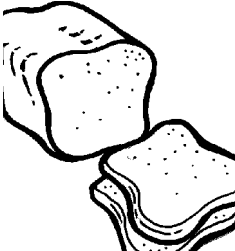
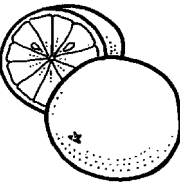

Excuse me, do you have any _____?



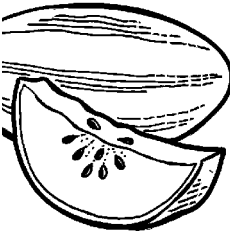
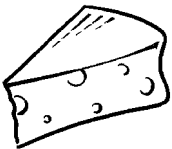
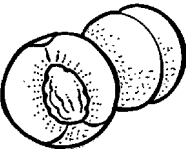

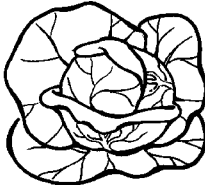
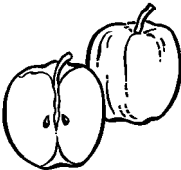

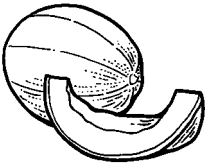
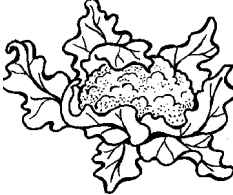
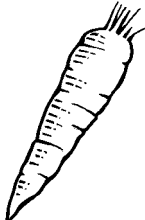
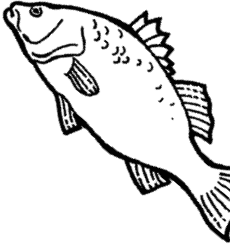
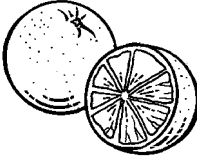
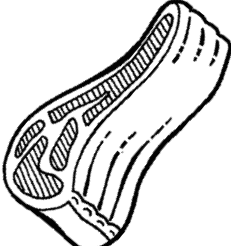

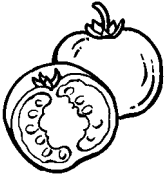





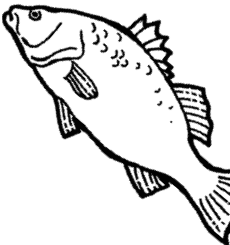
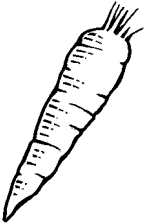

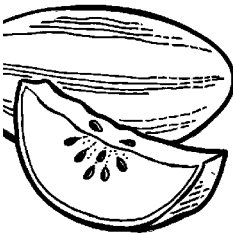
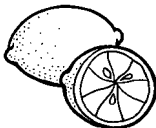





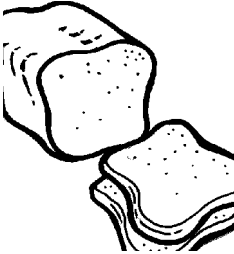
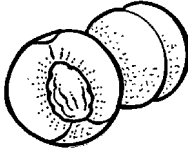

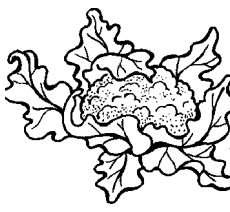
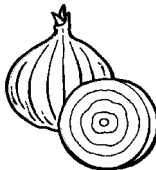
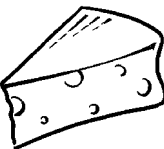

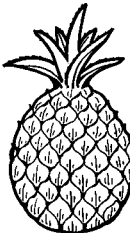
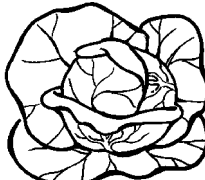



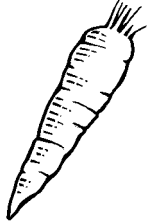
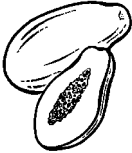

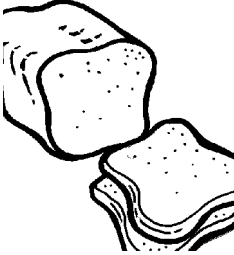

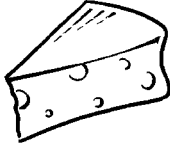
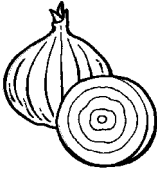
Excuse me, do you have any _____?

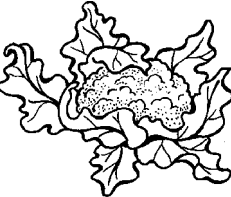
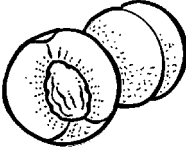
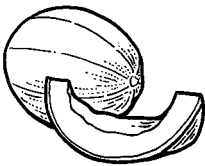

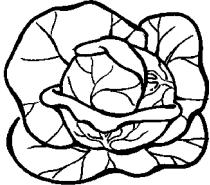

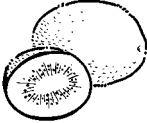
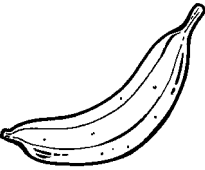
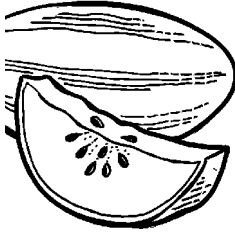

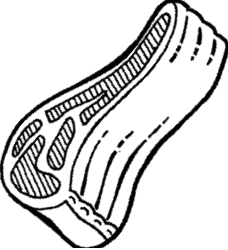



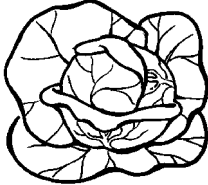
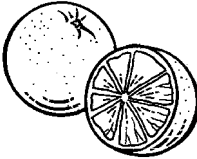
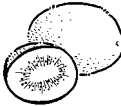
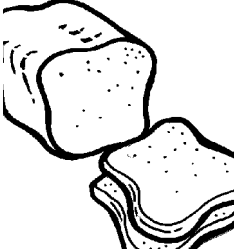
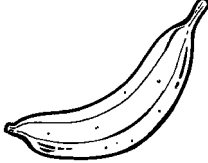
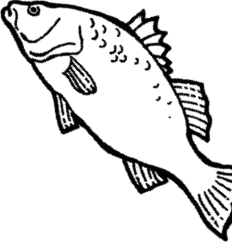
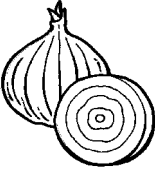

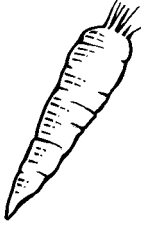
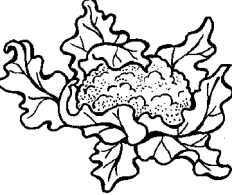

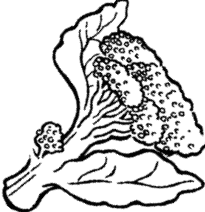

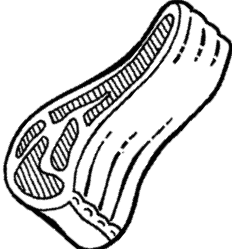
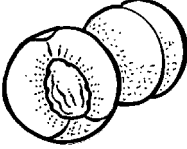
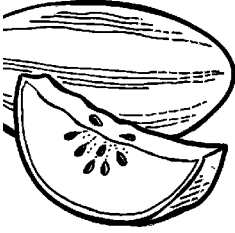
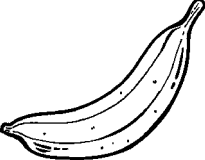
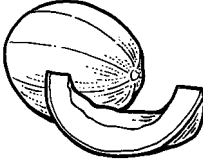
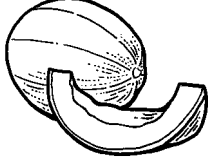



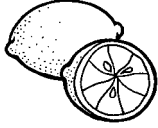

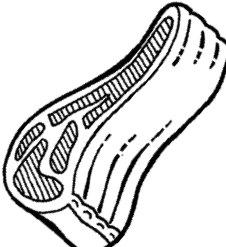



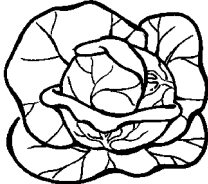

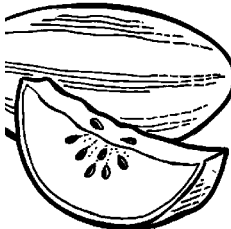
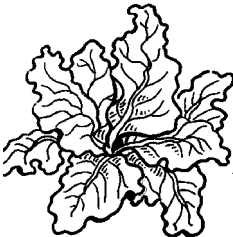
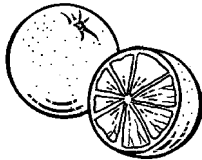
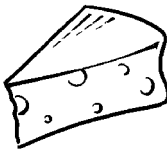
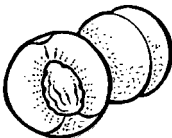
B	I	N	G	O
				
				
		free		
				
				

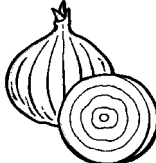

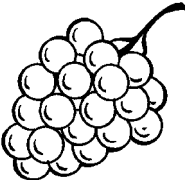
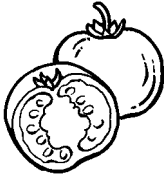

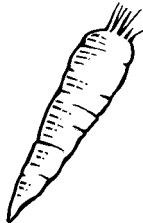

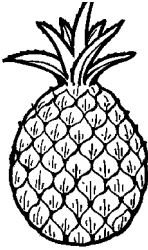





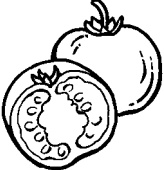
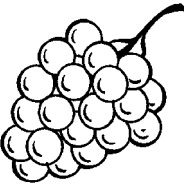

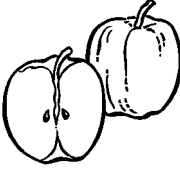
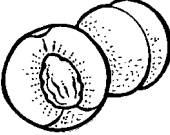
B	I	N	G	O
				
				
		free		
				
				

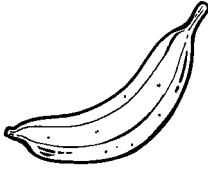
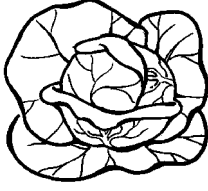



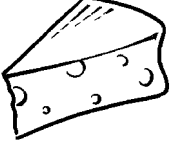

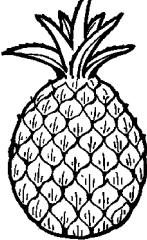
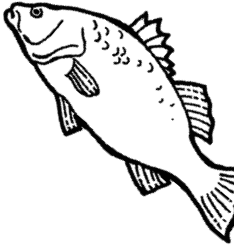
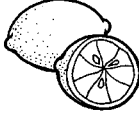
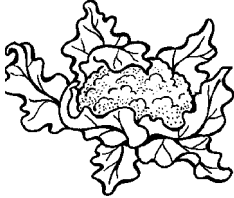

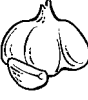
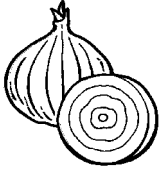

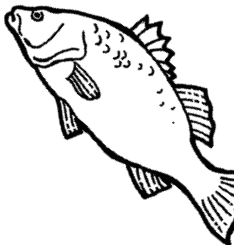



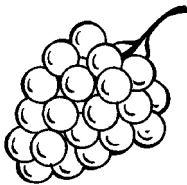
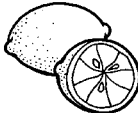
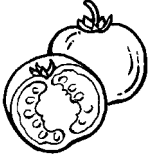
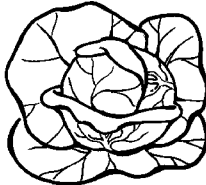

B	I	N	G	O
				
				
		free		
				
				

B	I	N	G	O
				
				
		free		
				
				

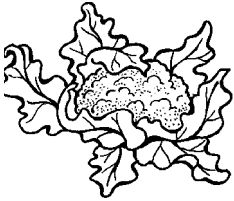
B	I	N	G	O
				
				
		free		
				
				

B	I	N	G	O
				
				
		free		
				
				

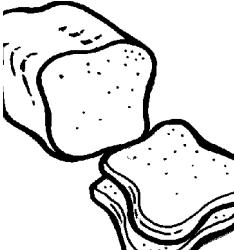
B	I	N	G	O
				
				
		free		
				
				

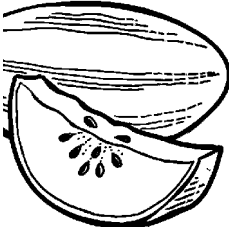
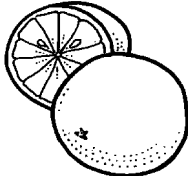
B	I	N	G	O
				
				
		free		
				
				

B	I	N	G	O
		free		

banana

orange

peach

kiwi

apple

lemon

pear

pineapple

plum

strawberry

watermelon

mango

grapefruit

cantaloupe

cherries

grapes

each

kg

cabbage

broccoli

spinach

green pepper

beans

carrot

cauliflower

garlic

mushroom

lettuce

potato

peas

tomato

onion

olives

ginger

eggs

cheese

bread

rice

chicken

fish

beef

pork

like

don't like

HOME

Do you have a VCR?

Objective

To identify common household items.

Goals

To learn the names of common household items.

Suggestions

- After completing the vocabulary in this chapter, cut all the words out and ask learners to group them into rooms of the house.
- You can introduce colors associated with household items. Teach the question, “What color is your ___?” Practice responding with a variety of colors.
- You may want to introduce the concepts of flea markets and yard sales for learners not already familiar with them.

Activities

- Introduce the question, “Where is the ___?” Also introduce basic prepositions. Look at the pictures of the rooms in this chapter and describe, using prepositions, where each item is.
- Use the sales flyers to make an information gap activity. See page 13.8 for an example of an information gap activity.
- Write the words in this chapter on separate pieces of paper. Ask learners to take the words home and tape them to the items (e.g. tape the word ‘fridge’ on the fridge.) Ask them to read the words each time they pass by the item in their home.
- Choose one room at a time and ask learners to collect pictures from magazines, newspapers or flyers of items in that room. Keep these pictures in a large envelope or glue them on bristol board. Collect these over a period of time, reviewing the vocabulary frequently. Eventually, items in all rooms will be represented. Learners can ask each other, “Do you have a ___?”, responding with the appropriate responses. This can lead to a discussion about present furniture and appliances and descriptions of homes and household items in learners’ previous homes.

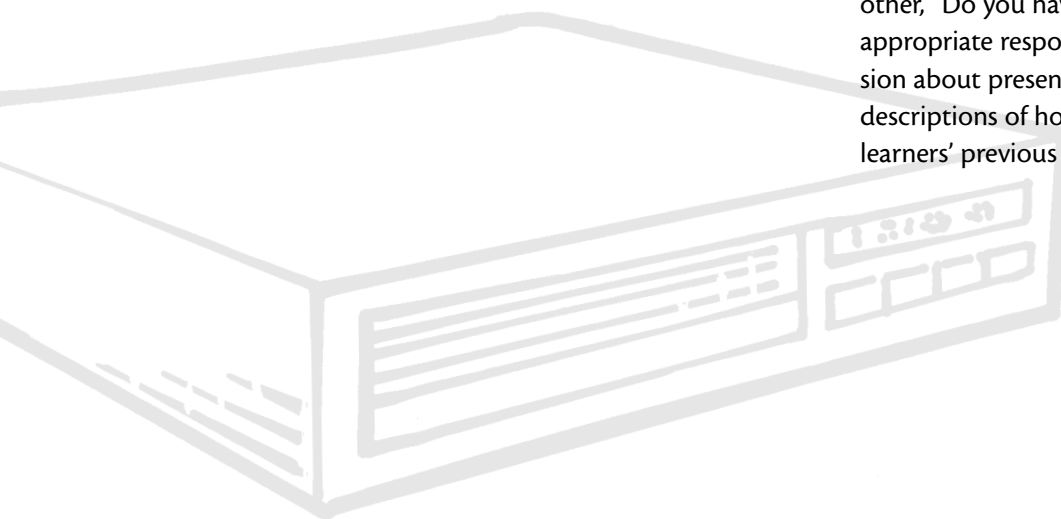

Instructors can:

- say the words on this page and ask learners to point to them.
- write the words on this page on separate pieces of paper. Show the words and ask learners to point to the correct picture.

Learners can:

- read the words on this page.
- write these words on a separate paper.
- cut up the words and the pictures and match them.
- cut the words in half. Mix them up and put the words back together.
- cut out the words and put them in alphabetical order.
- cut out the pictures and put them in alphabetical order.

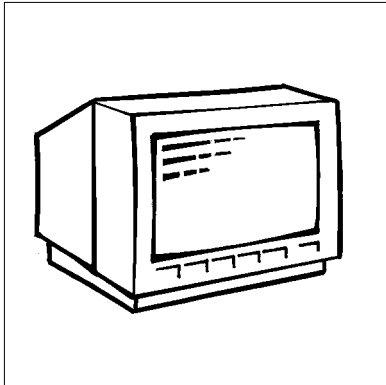

TV

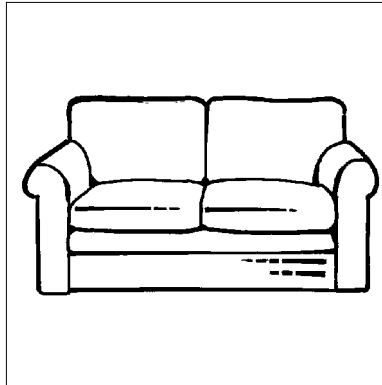

couch

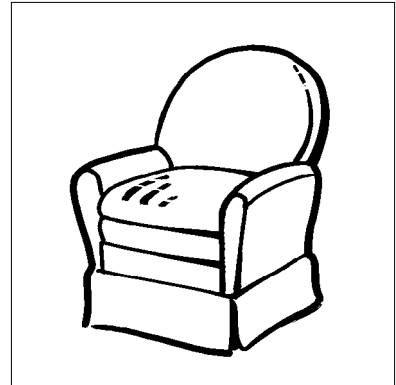

chair

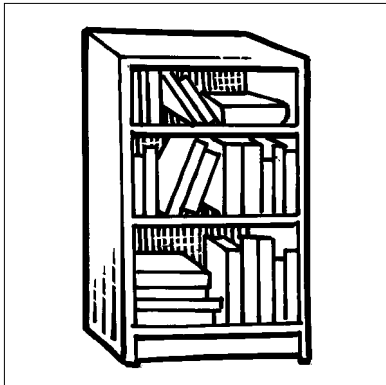

bookcase

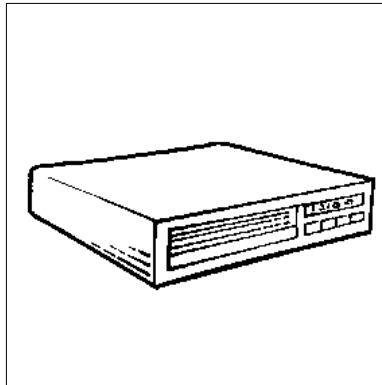

VCR

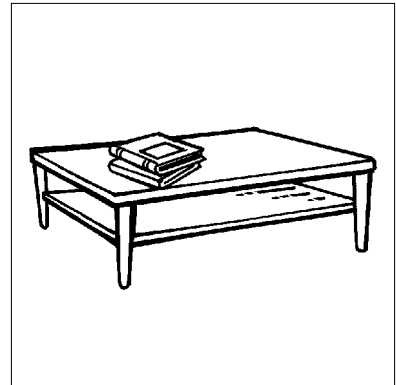

coffee table

Instructors can:

- review the question, "How do you spell ___?"
- ask learners, "How do you spell ___?" Learners respond by spelling the words.
- say a word and ask learners to point to it.
- write the words on this page on separate pieces of paper. Show learners a word and ask them to point to the same word on their page.

Learners can:

- fill in the blanks with the correct letter.
- work in pairs. Fold the paper so one learner has the completed word and the other has the words with blanks. The learner with the picture and the complete words says the name of the household item. The other learner asks, "How do you spell that?" The learner with the completed words spells the word as the other learner fills in the blanks.
- after filling in the blanks, learners can cut out the words and pictures and then match them.

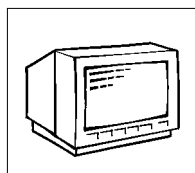

TV

__V

T__

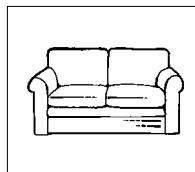

couch

__ouch

COU__ __

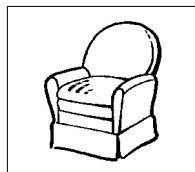

chair

__ __air

chai__

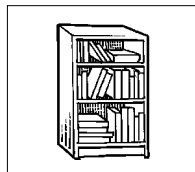

bookcase

__ookcase

bookca__e

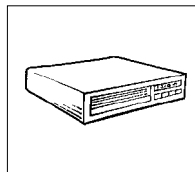

VCR

__CR

VC__

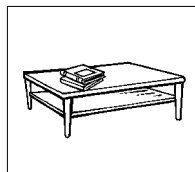

coffee table

__offee __able

coffe__ tab__e

Instructors can:

- say words on this page and ask learners to point to them.
- say the words for the pictures and ask learners to circle the words.
- write the words on this page on separate pieces of paper. Show learners a word and ask them to circle all of the same words.

Learners can:

- read the words on this page.
- circle the correct word.
- cut up the pictures and the words. Match the words with the pictures.
- cut up the words. Mix them up and group the same words together.

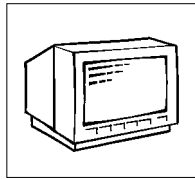

VCR

TV

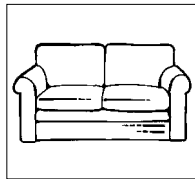

couch

bookcase

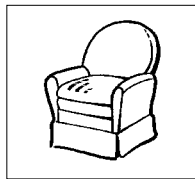

chair

coffee table



TV

bookcase

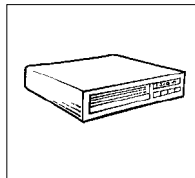

VCR

couch

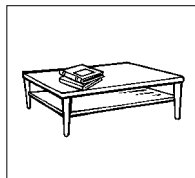

coffee table

chair

Instructors can:

- say the sentences and ask learners to say “yes” or “no”.
- say a sentence and ask learners to point to the sentence.
- say a sentence and ask learners to repeat the sentence.
- teach the question, “Do you have a ___?”

Learners can:

- read the sentences.
 - circle yes if the sentence is true and circle no if it is not true.
 - copy the true sentences on a separate paper.
 - ask each other, “Do you have a ___?”
 - work in pairs. Learner A asks her partner, “Do you have a ___”? Learner B says either “yes” or “no”. Learner A circles ‘yes’ or ‘no’.
-

I have a TV .	yes	no
I have a couch .	yes	no
I have a chair .	yes	no
I have a bookcase .	yes	no
I have a VCR .	yes	no
I have a coffee table .	yes	no

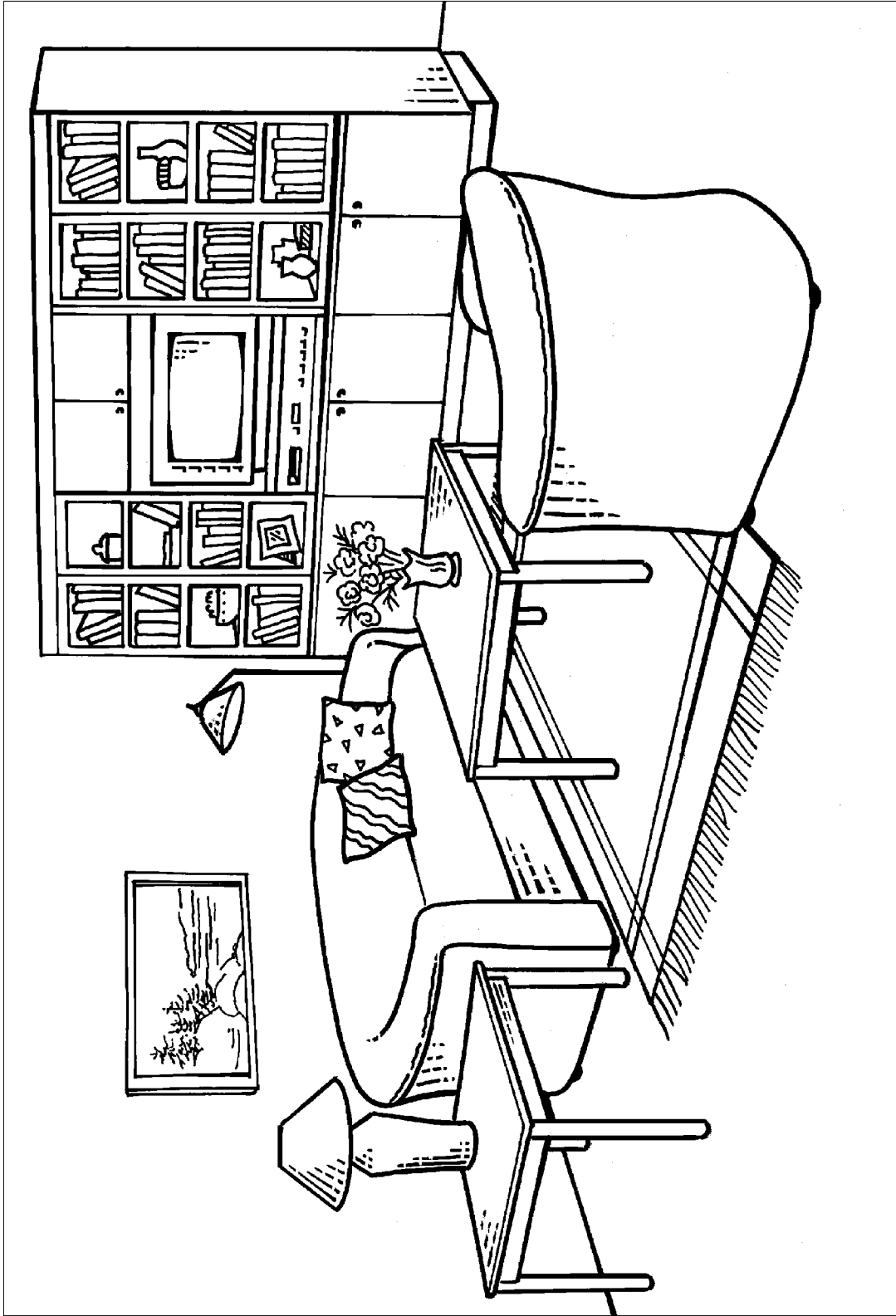

living room

Instructors can:

- say the words on this page and ask learners to point to them.
- write the words on this page on separate pieces of paper. Show the words and ask learners to point to the correct picture.

Learners can:

- read the words on this page.
 - write these words on a separate paper.
 - cut up the words and the pictures and match them.
 - cut the words in half. Mix them up and put the words back together.
 - cut out the words and put them in alphabetical order.
 - cut out the pictures and put them in alphabetical order.
-

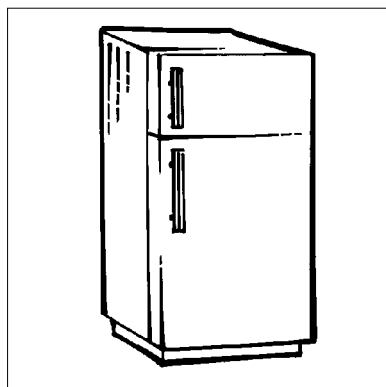

fridge

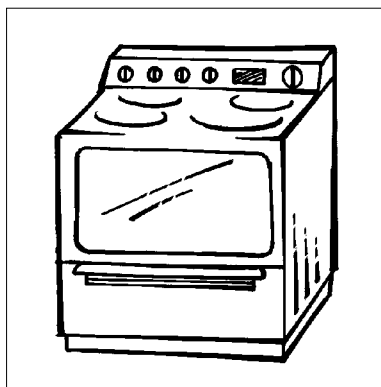

stove

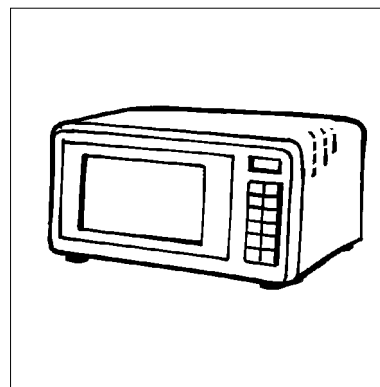

microwave

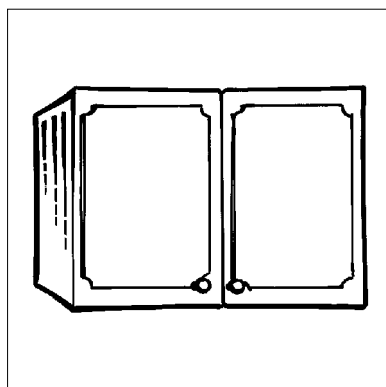

cupboard

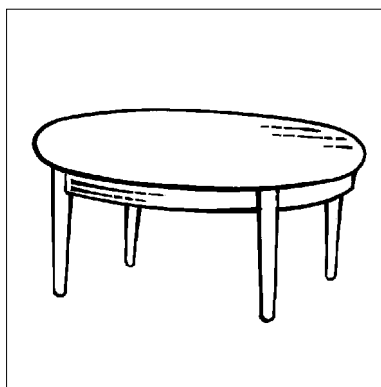

table

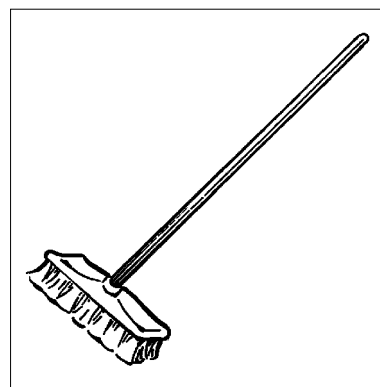

broom

Instructors can:

- say the words in the left column. Ask learners to repeat the words.

Learners can:

- read the words in the left column.
- circle the words on each line.

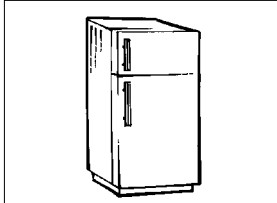

fridge

fripfridgespwfridgeeunbz

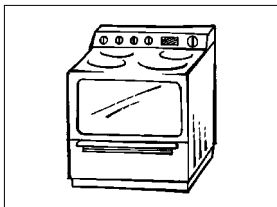

stove

evotsstoveequcfstststove

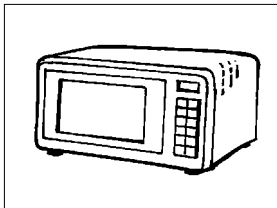

microwave

micromicrowavewavemvtu

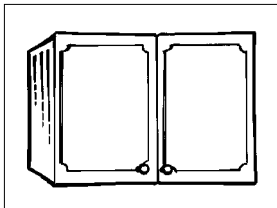

cupboard

cupboardwrtpcupboarddf

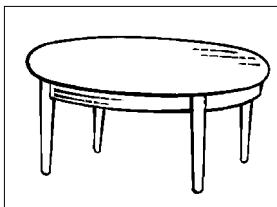

table

adxlmtableelbatwbbleeru

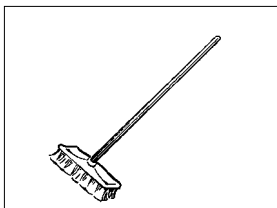

broom







prppoomrbroomsacbmdom

Instructors can:

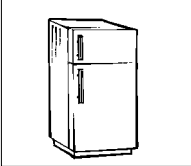
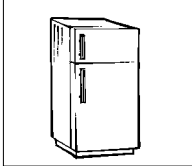
- say a word on this page and ask learners to point to it.
- say a word on this page and ask learners to write the word in the blank.
- write these words on separate pieces of paper. Show learners a word from this page and ask them to point to the same word.
- fill in some of the blanks to make the activity easier.

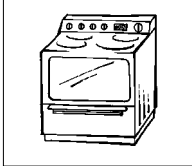
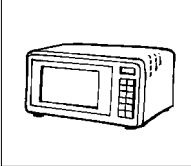
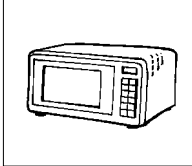
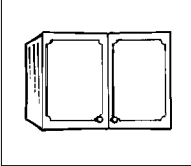
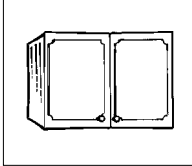
Learners can:

- look at the pictures and read the words beside the pictures.
- copy the words into the blanks.
- fold the paper so the words are hidden and write the words in the blanks.
- work in pairs. Cut the words off this paper. Cut the list of words in half. Ask her partner, "How do you spell ___?" Her partner spells the word and she writes it in the blank.

	fridge	_____	
	stove	_____	
	microwave	_____	
	cupboard	_____	
	table	_____	
	broom	_____	

✂

Instructors can:

- say the word and ask learners to circle the correct picture.
- say the word and ask learners to circle all the pictures of that word.

Learners can:

- read the word and circle the correct picture.
- write the words below the pictures.

fridge

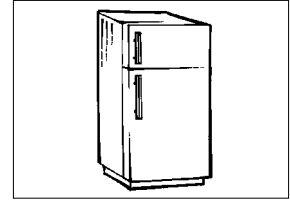
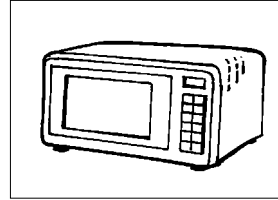
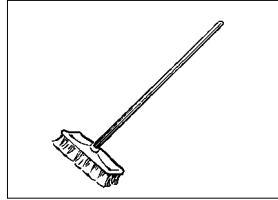

stove

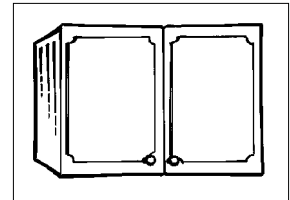
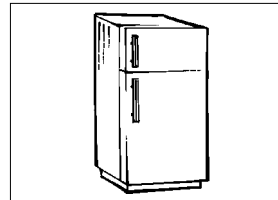
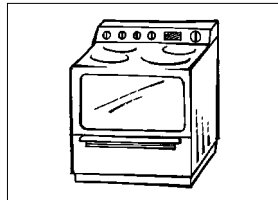

microwave

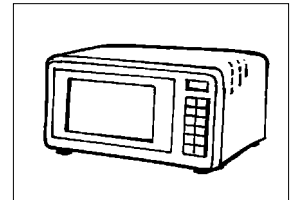
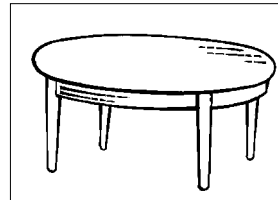
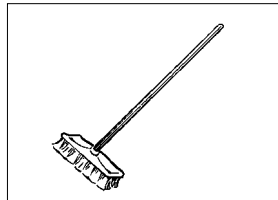

cupboard

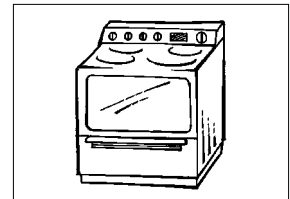
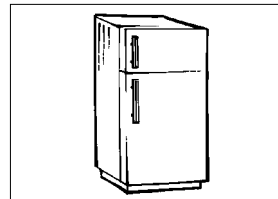
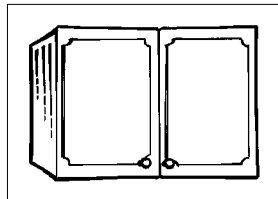

table

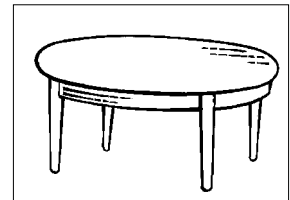
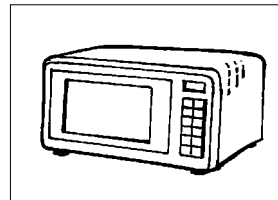
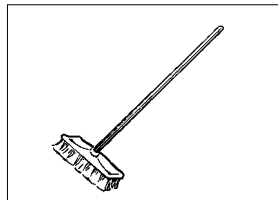

broom

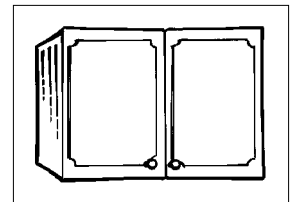
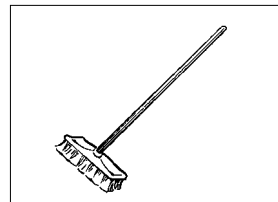
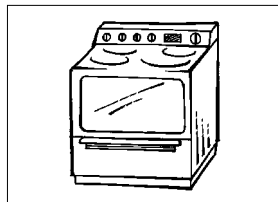

Kitchen

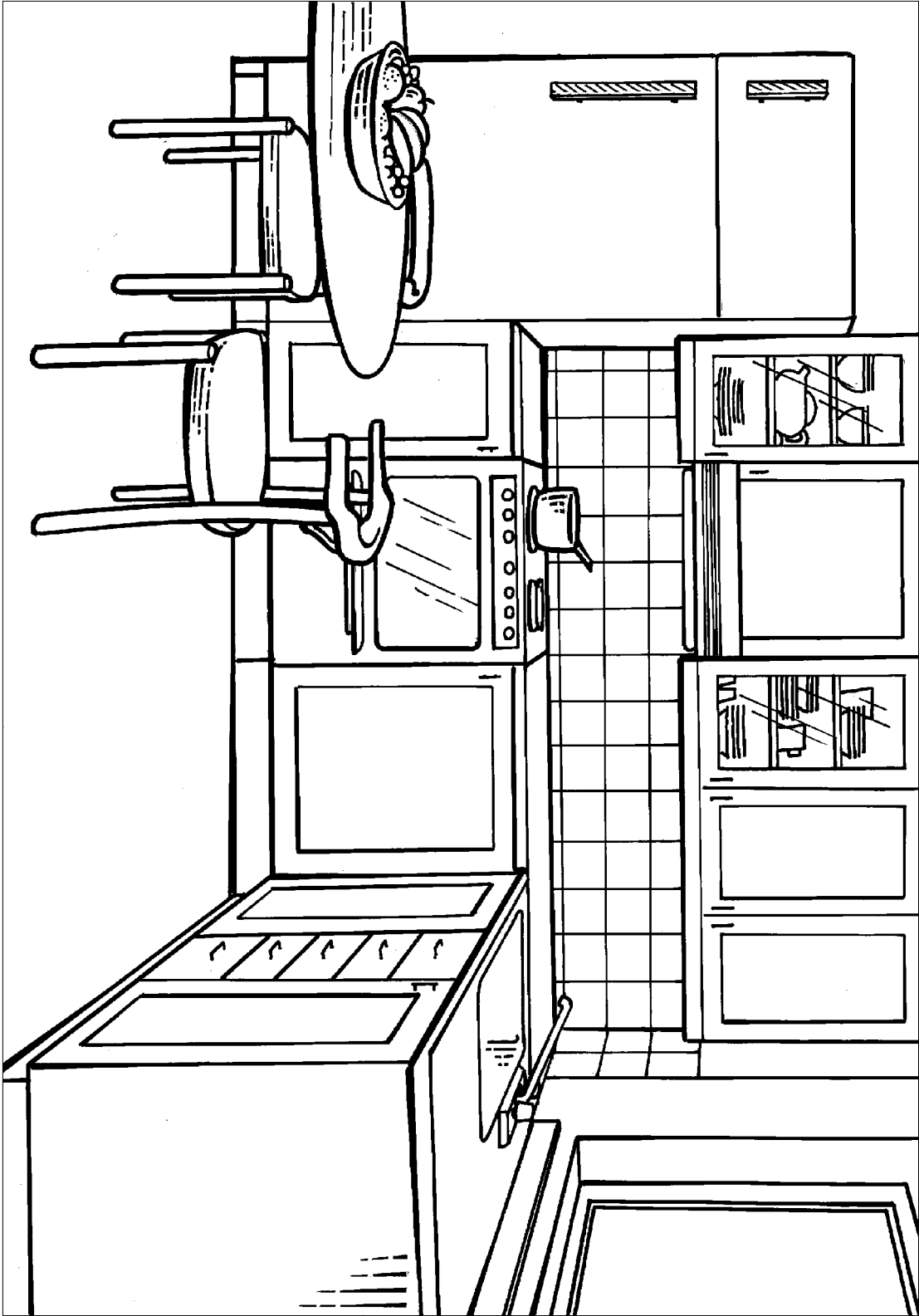

Instructors can:

- say the words on this page and ask learners to point to them.
- write the words on this page on separate pieces of paper. Show the words and ask learners to point to the correct picture.

Learners can:

- read the words on this page.
- write these words on a separate paper.
- cut up the words and the pictures and match them.
- cut the words in half. Mix them up and put the words back together.
- cut out the words and put them in alphabetical order.
- cut out the pictures and put them in alphabetical order.

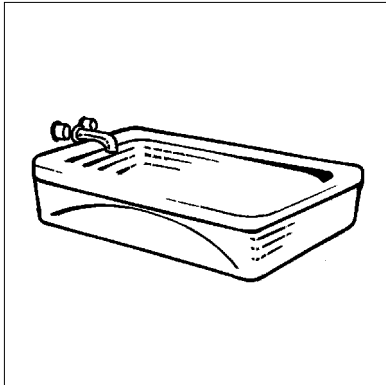

bathtub

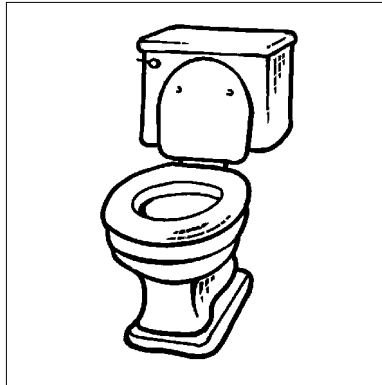

toilet

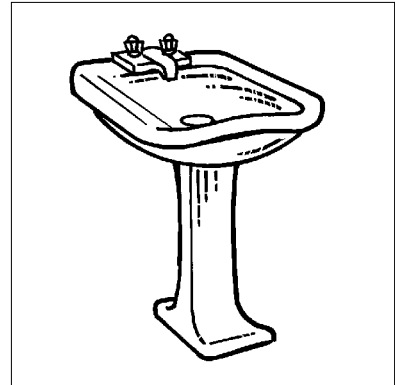

sink

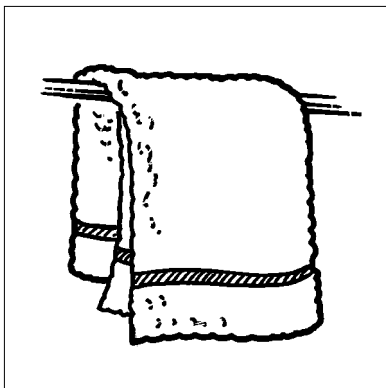

towel

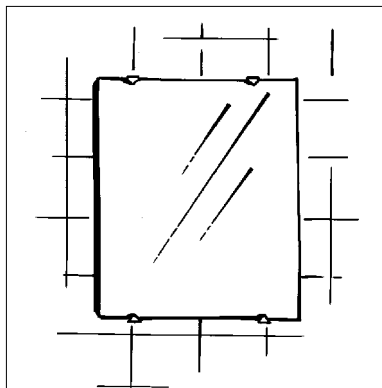

mirror

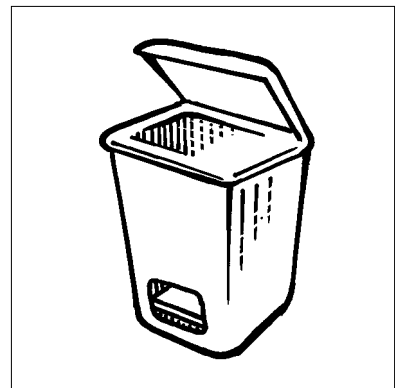

garbage can

Instructors can:

- review the question, "How do you spell ___?"
- say the words on this page and ask learners to circle them.
- say the words on this page and ask learners to spell them.

Learners can:

- read the words on this page.
- copy the words in the blanks.
- work in pairs. Fold the paper and ask, "How do you spell ___?" The partner spells the word.

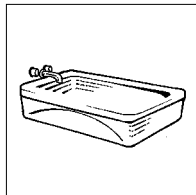

bathtub

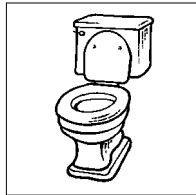

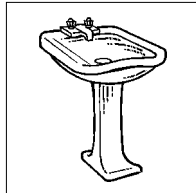

sink

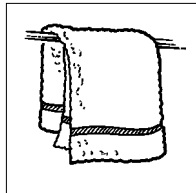

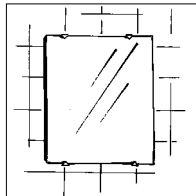

mirror

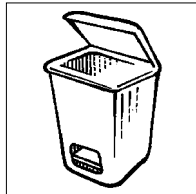

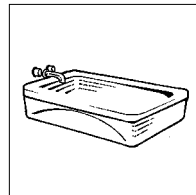

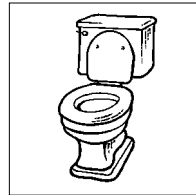

toilet

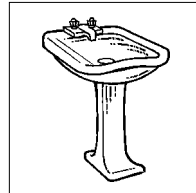

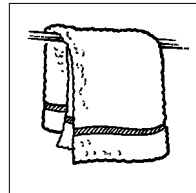

towel

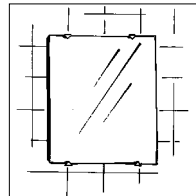

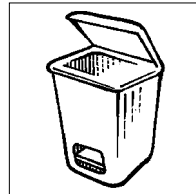

garbage
can

Instructors can:

- say a word and ask learners to circle it.
- write the words on this page on separate pieces of paper. Show the words and ask learners to count how many are on the page.
- write the words on this page on separate pieces of paper. Show a word and ask learners to circle that word on the page.
- say the first word in each line and ask learners to repeat the word.

Learners can:

- read the first word on each line and circle the word that is the same.
- cut up the words and group the same words together.
- copy the words on to a separate paper.

bathtub	mirror	toilet	bathtub
toilet	toilet	towel	sink
sink	towel	sink	garbage can
towel	towel	mirror	bathtub
mirror	sink	bathtub	mirror
garbage can	toilet	bathtub	garbage can

Instructors can:

- say the words in the left column. Ask learners to repeat the words.
- say a word on this page and ask learners to point to it.

Learners can:

- read the words in the left column.
 - circle the correct spelling.
-

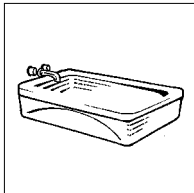

bathtub

pathtub

bathtub

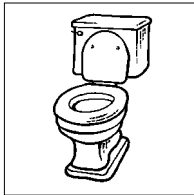

toilet

toile

toilet

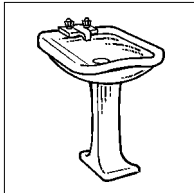

sink

sinc

sink

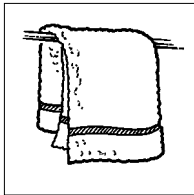

towel

towel

tewol

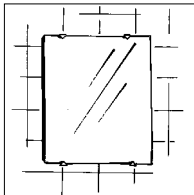

mirror

miror

mirror

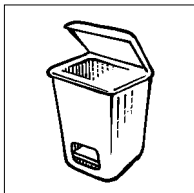

garbage can

darbage can

garbage can

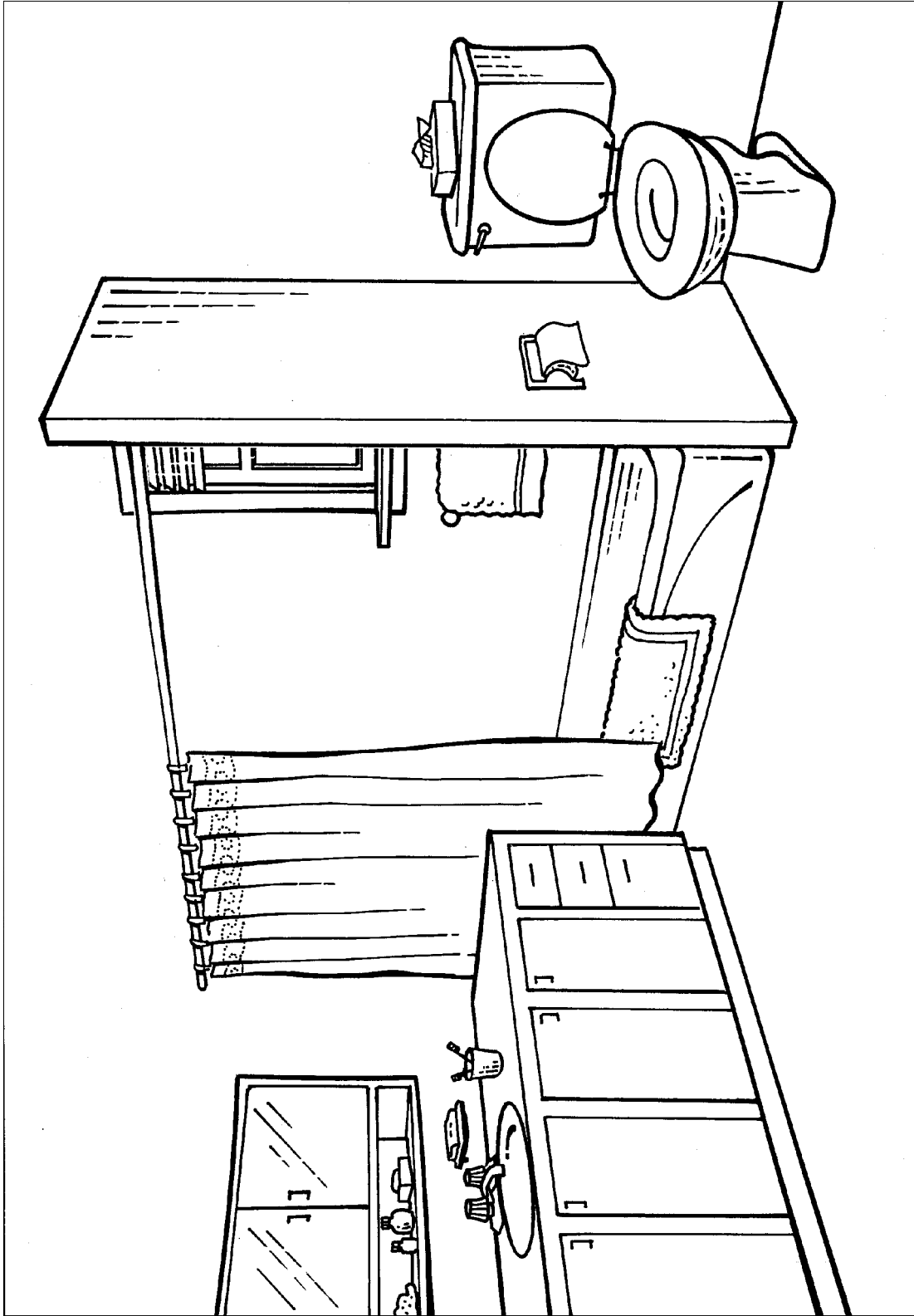

bathroom

Instructors can:

- say the words on this page and ask learners to point to them.
- write the words on this page on separate pieces of paper. Show the words and ask learners to point to the correct picture.

Learners can:

- read the words on this page.
 - write these words on a separate paper.
 - cut up the words and the pictures and match them.
 - cut the words in half. Mix them up and put the words back together.
 - cut out the words and put them in alphabetical order.
 - cut out the pictures and put them in alphabetical order.
-

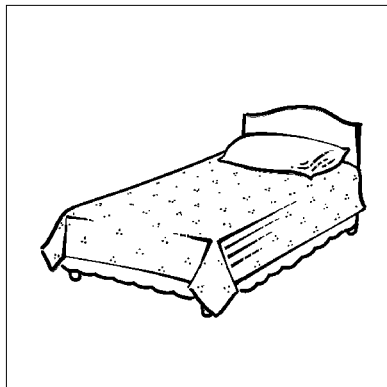

bed

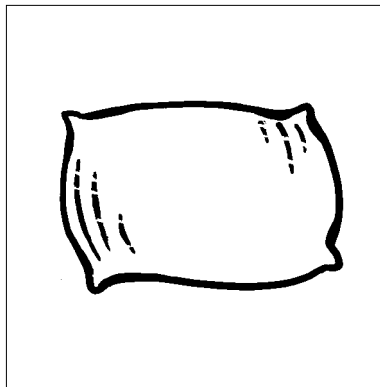

pillow

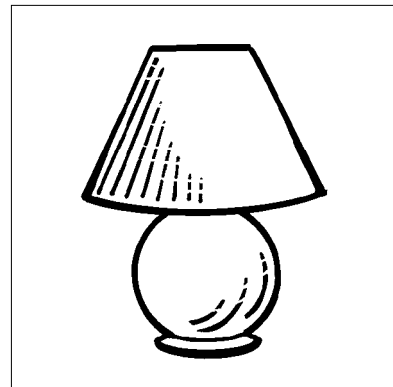

lamp

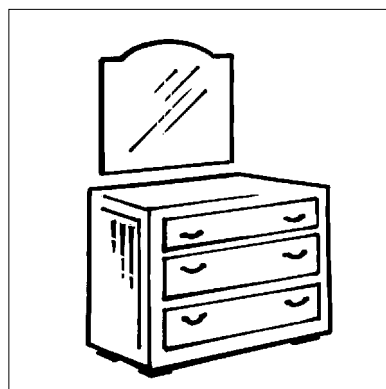

dresser



crib

Instructors can:

- review the question, "How do you spell ___?"
- ask learners, "How do you spell ___?" Learners respond by spelling the words.
- say a word and ask learners to point to it.
- write the words on this page on separate pieces of paper. Show learners a word and ask them to point to the same word on their page.

Learners can:

- fill in the blanks with the correct letter.
- work in pairs. Fold the paper so one learner has the completed word and the other has the words with blanks. The learner with the picture and the complete words says the name of the household item. The other learner asks, "How do you spell that?" The learner with the completed words spells the word as the other learner fills in the blanks.
- after filling in the blanks, learners can cut up the page and match the words with the pictures.

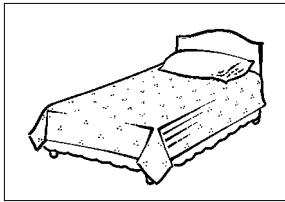

bed

__ed

be__

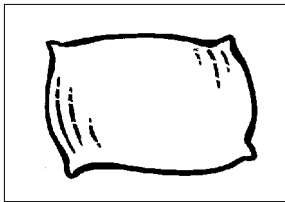

pillow

__illow

pill__w

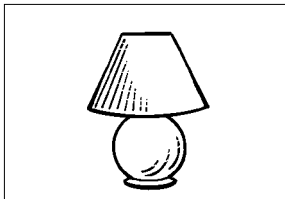

lamp

__amp

lam__

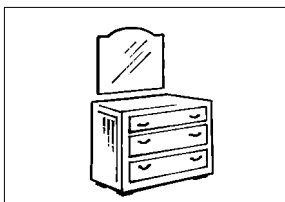

dresser

__resser

dresse__

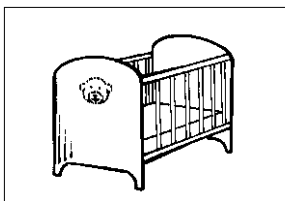

crib

__rib

cri__

Instructors can:

- say the word and ask learners to circle the correct picture.
- say the word and ask learners to circle all the pictures of that word.

Learners can:

- read the word and circle the correct picture.
- write the words below the pictures.

bed

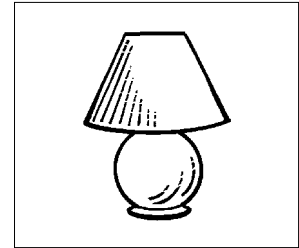
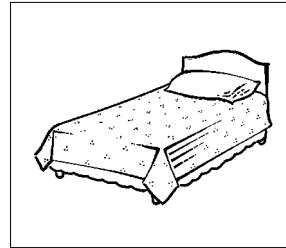
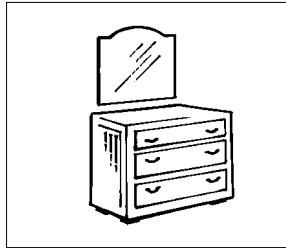

pillow

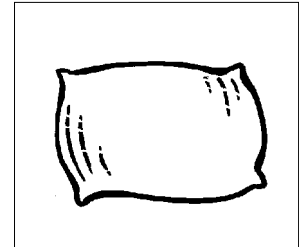
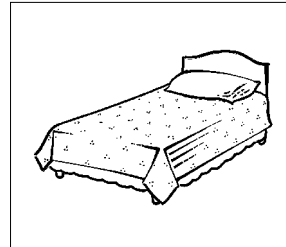
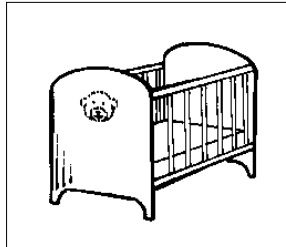

lamp

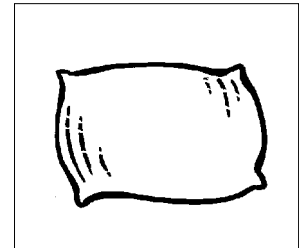
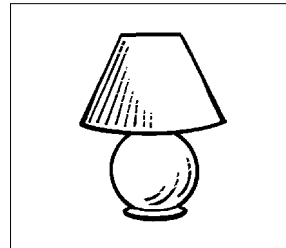
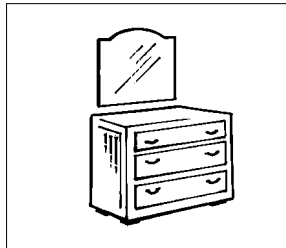

dresser

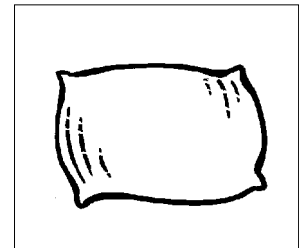
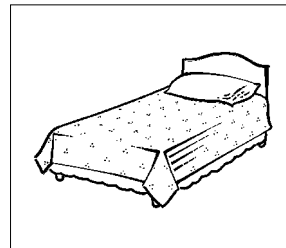
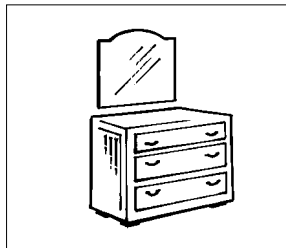

crib

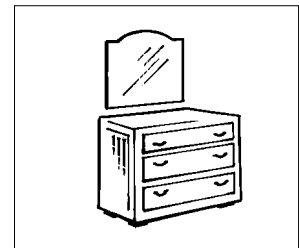
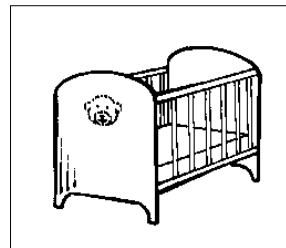
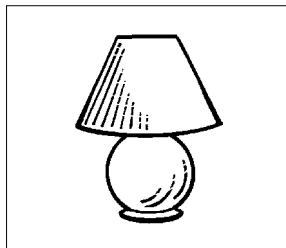

Instructors can:

- review the question, "How do you spell ___?"
- say the words on this page and ask learners to circle them.
- say the words on this page and ask learners to spell them.
- say the words on this page and ask learners to point to them.
- say the words on this page and ask learners to write them in the blanks.

Learners can:

- read the words on this page.
- copy the words in the blanks.
- work in pairs. Learner A covers the words and asks, "How do you spell ___?" Learner B spells the word. Learner A listens and writes the word in the blank.

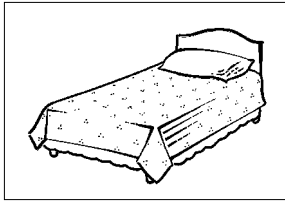

bed

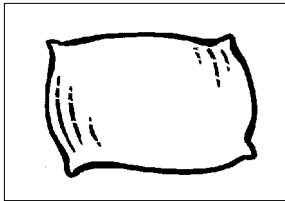

pillow

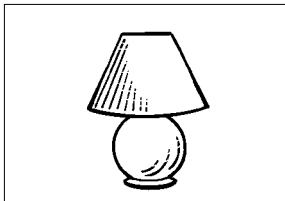

lamp

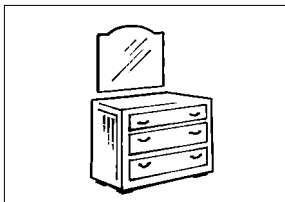

dresser

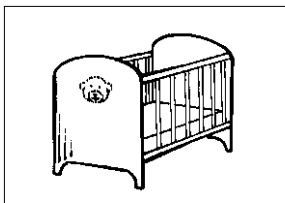

crib

bedroom

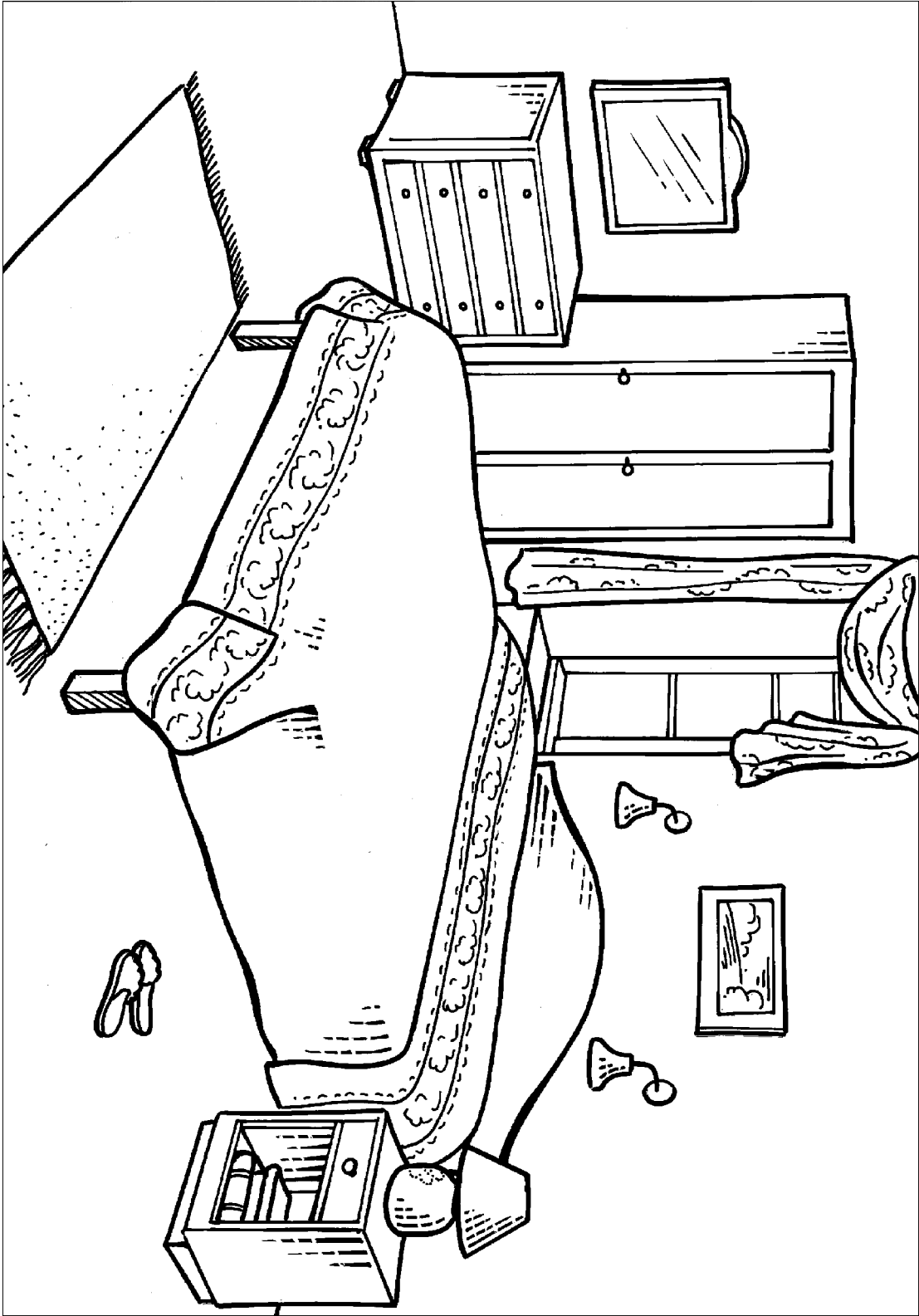

Find and Circle

a	b	c	d	b	o	o	k	c	a	s	e	e
l	h	t	p	m	i	r	r	o	r	d	p	g
a	b	o	i	m	t	a	c	f	v	r	s	c
m	r	i	l	z	a	s	o	w	c	e	h	u
p	o	l	l	p	b	i	u	c	r	s	m	p
a	o	e	o	l	l	n	c	t	v	s	i	b
o	m	t	w	j	e	k	h	w	e	e	c	o
g	a	r	b	a	g	e	c	a	n	r	r	a
b	e	d	i	b	a	t	h	t	u	b	o	r
c	o	f	f	e	e	t	a	b	l	e	w	d
c	r	i	b	i	y	c	h	a	i	r	a	a
s	t	o	v	e	t	o	w	e	l	s	v	b
q	f	r	i	d	g	e	r	x	p	n	e	n

fridge

stove

microwave

cupboard

table

broom

tv

couch

chair

bookcase

vcr

coffee table

bathtub

toilet

sink

mirror

garbage can

bed

pillow

lamp

dresser

crib

towel

bathtub

toilet

sink

towel

mirror

garbage can

bed

pillow

lamp

dresser

crib

TV

couch

chair

bookcase

VCR

coffee table

fridge

stove

microwave

cupboard

table

broom

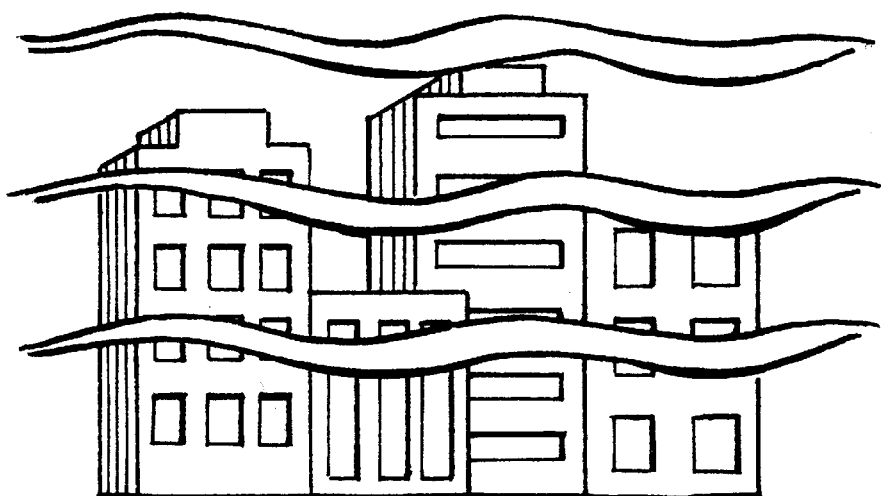
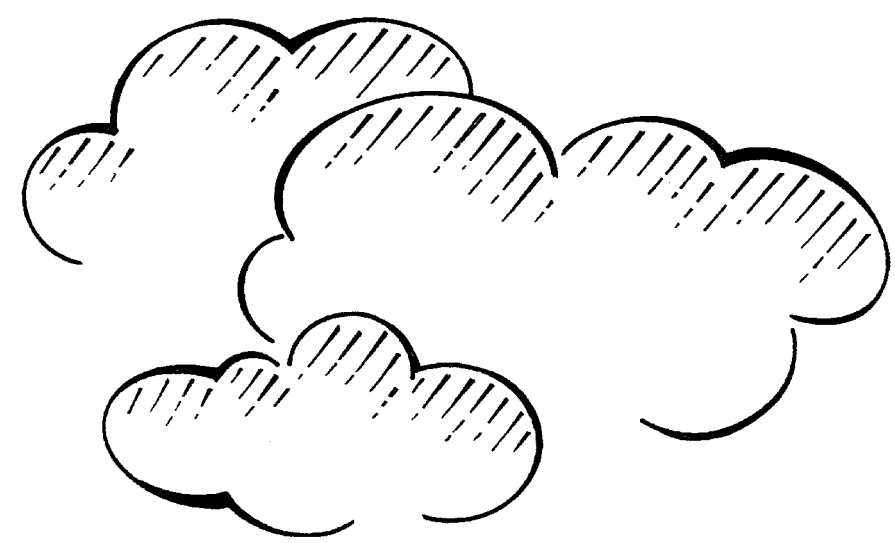
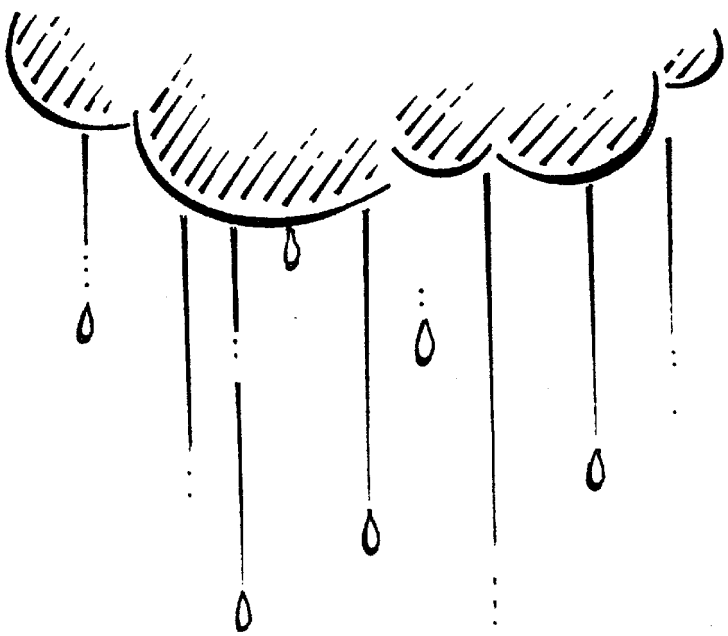
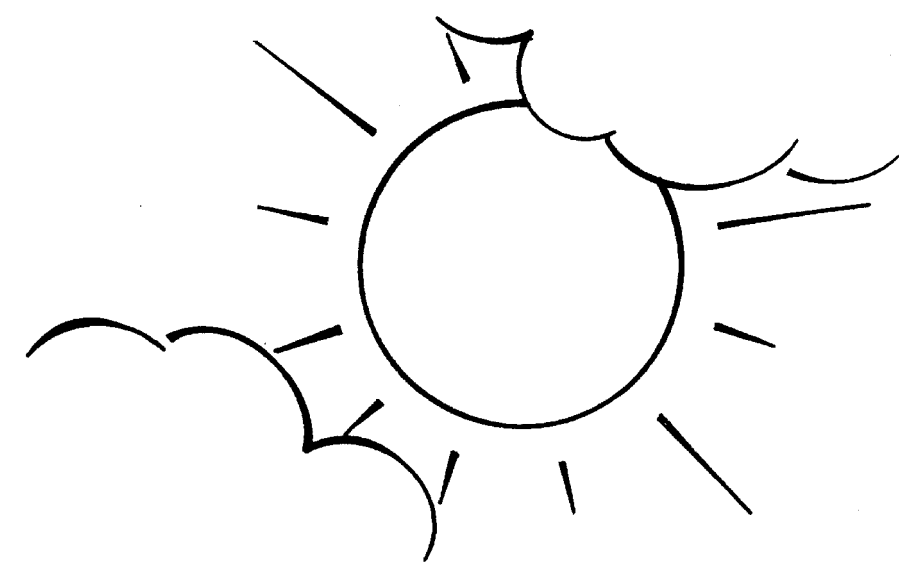
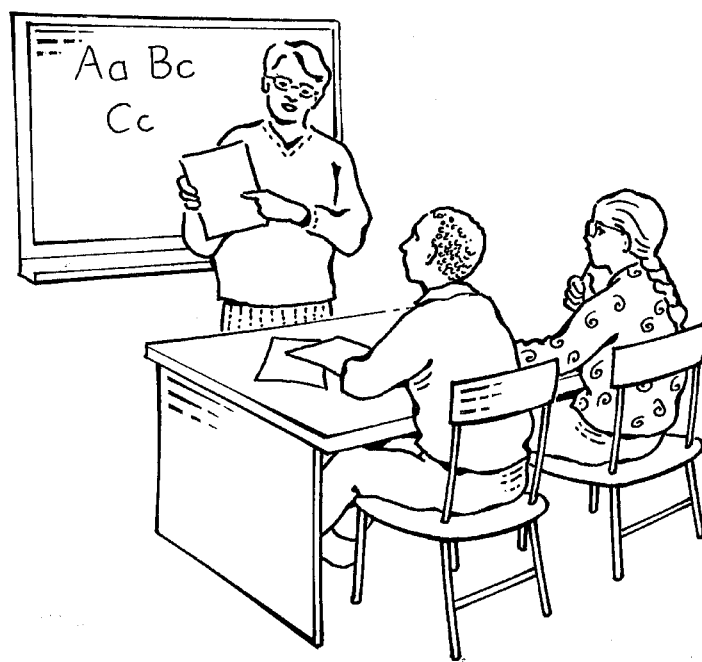
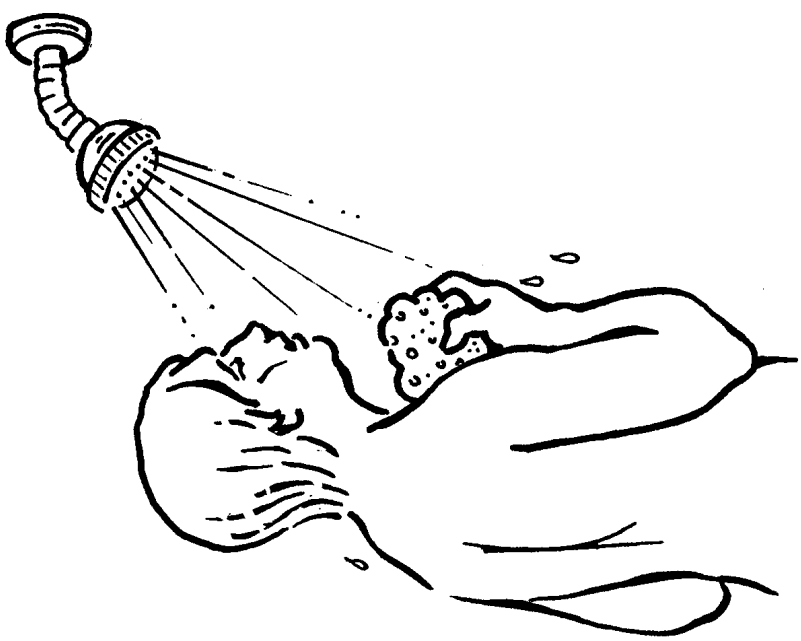
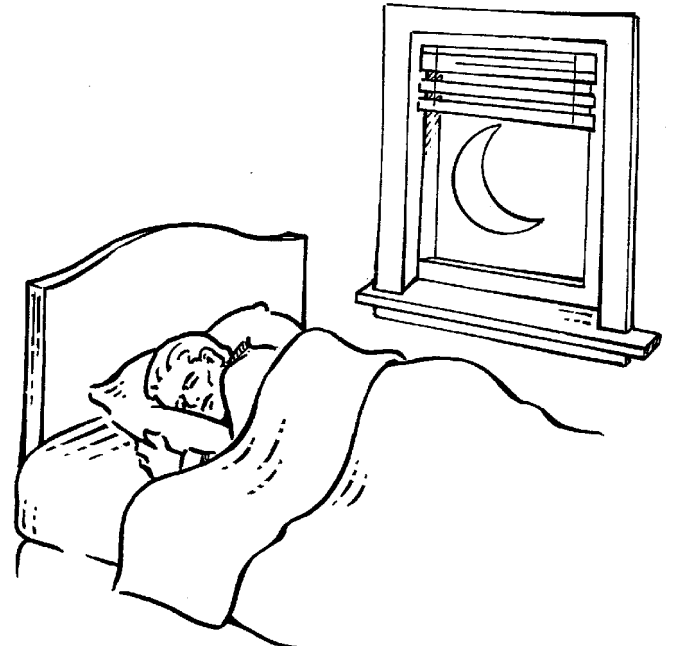
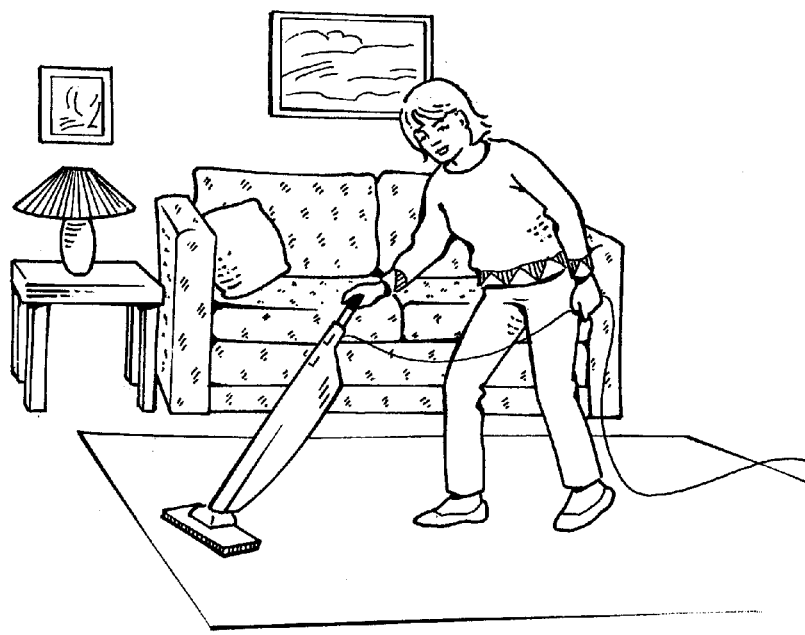
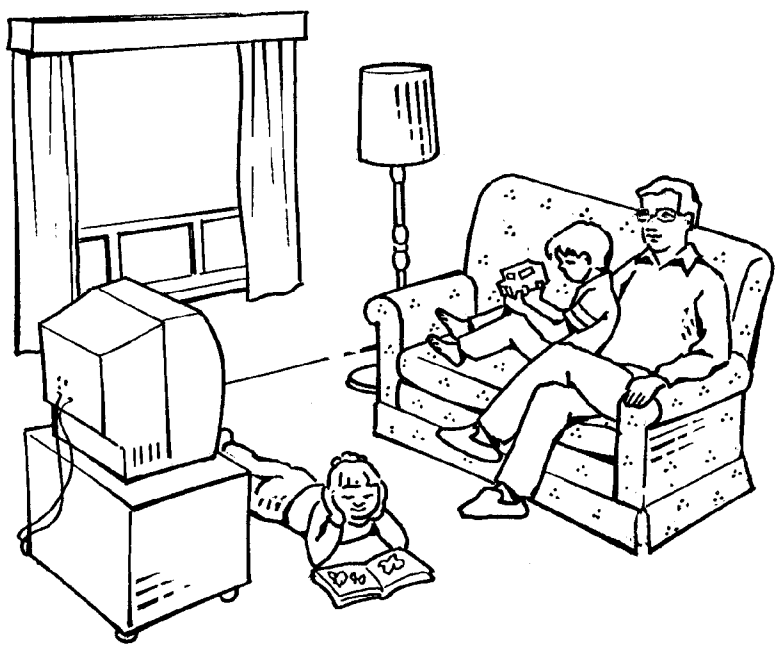
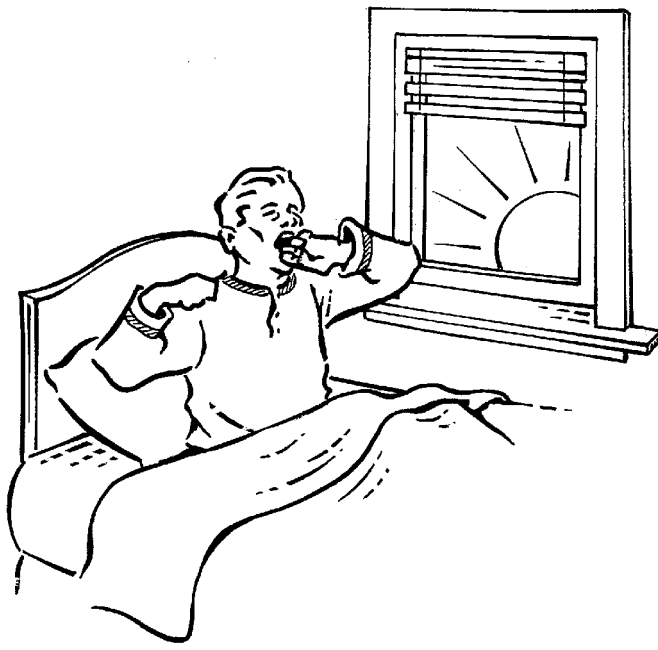
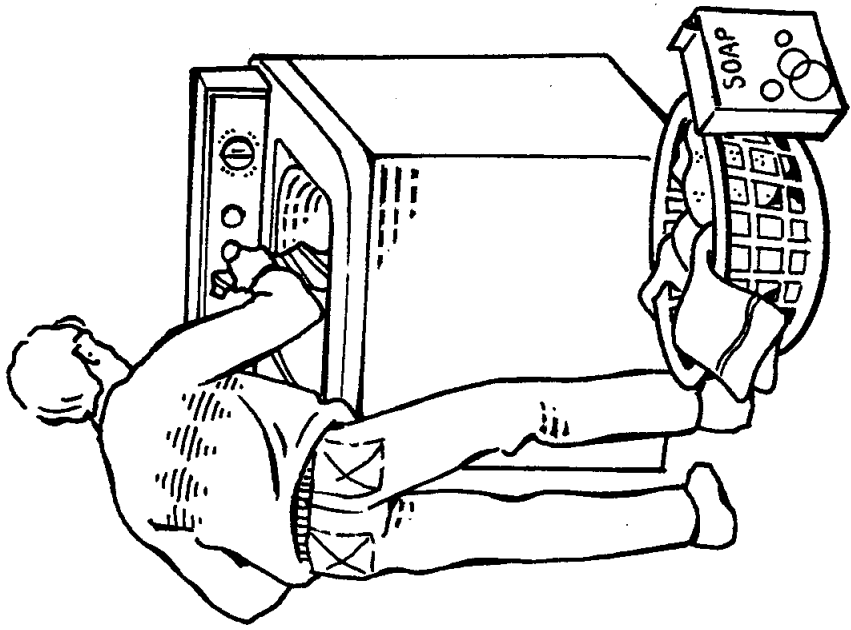
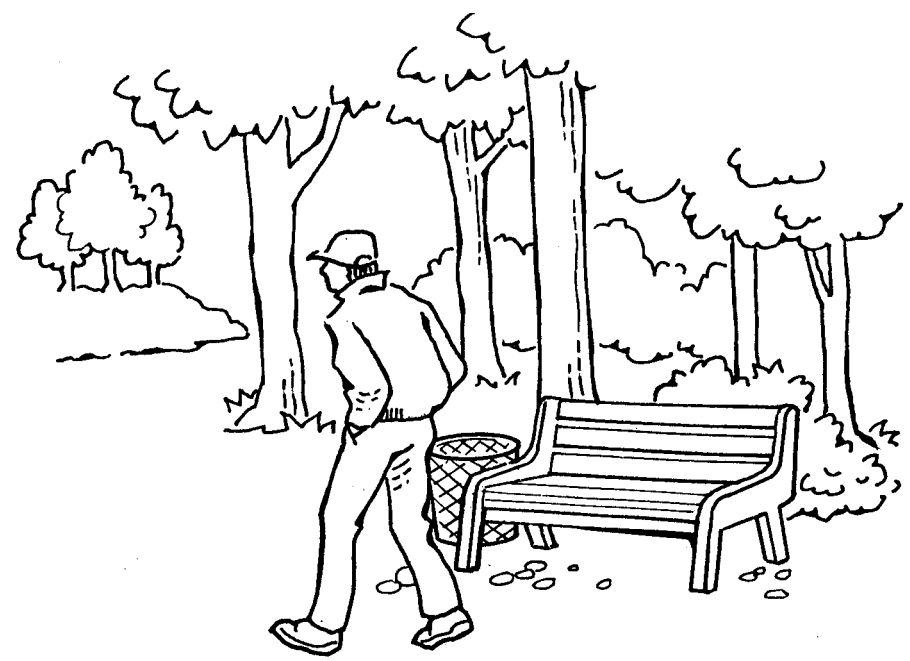
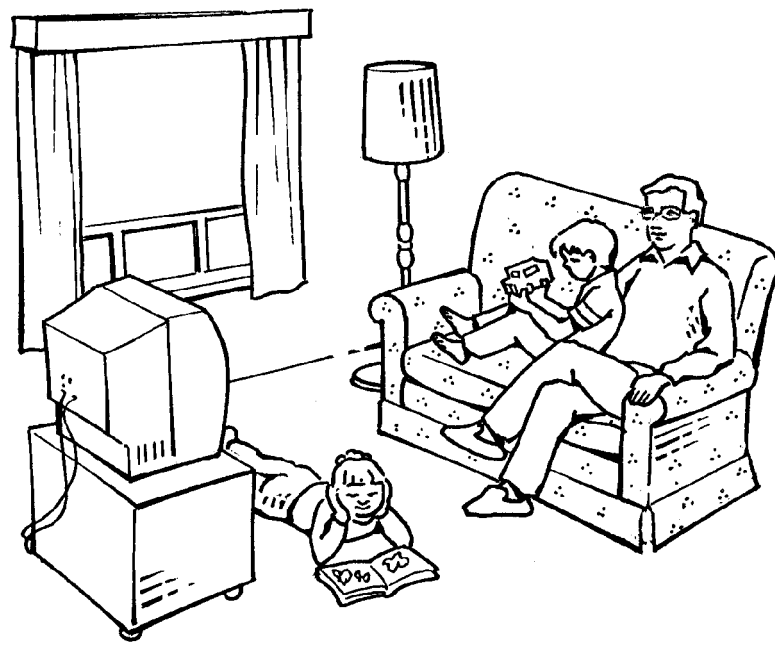
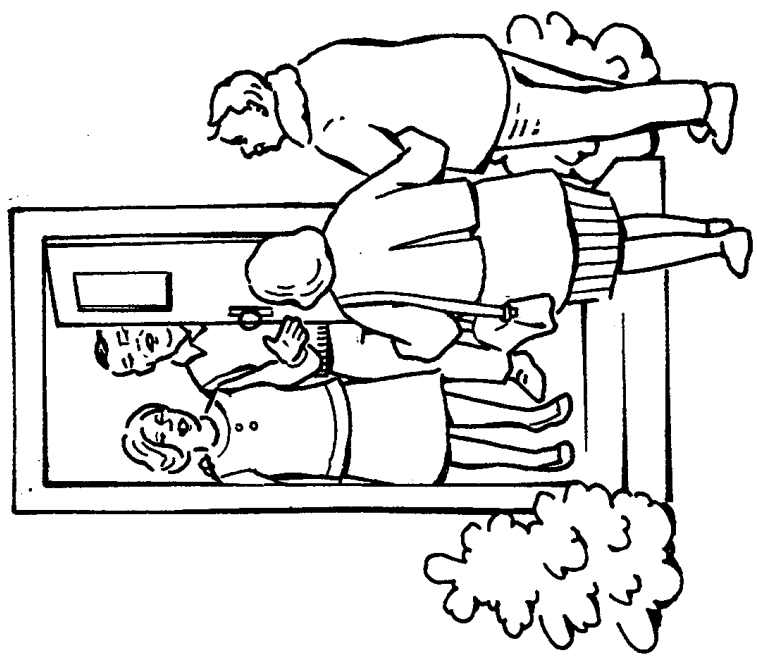
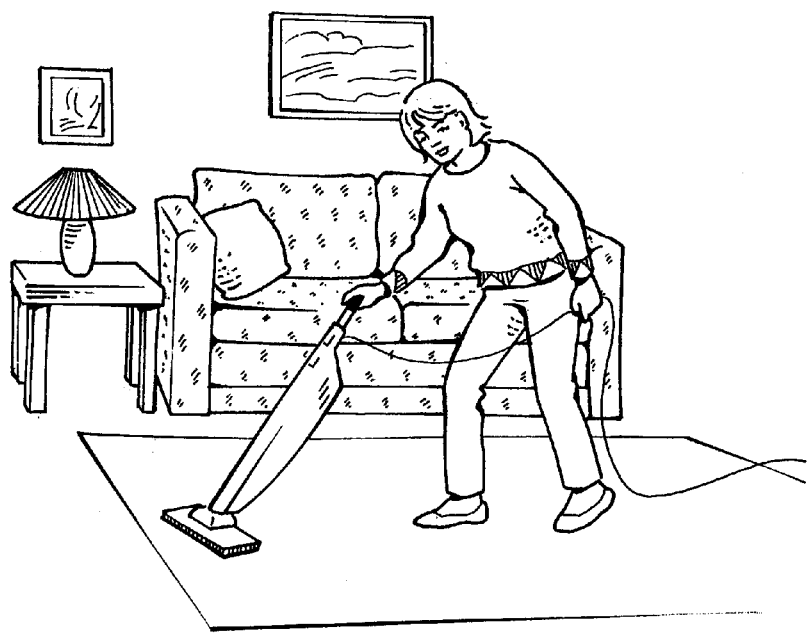
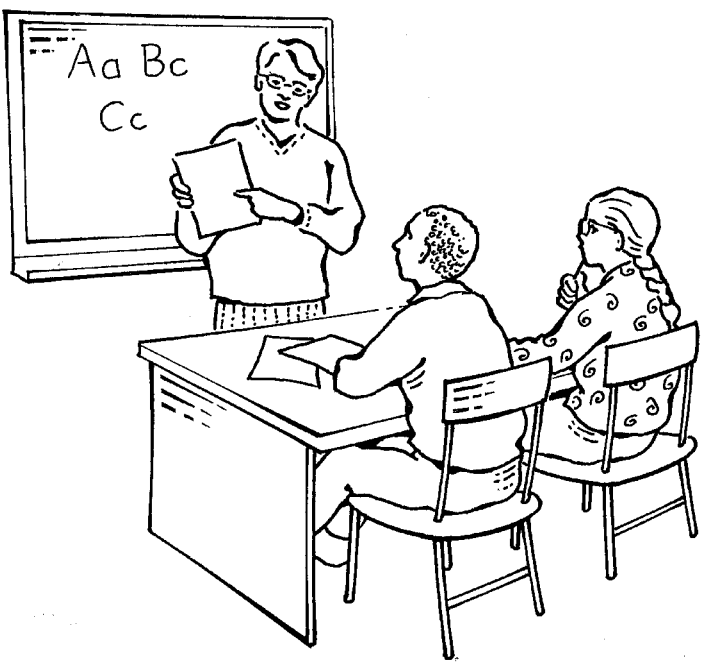

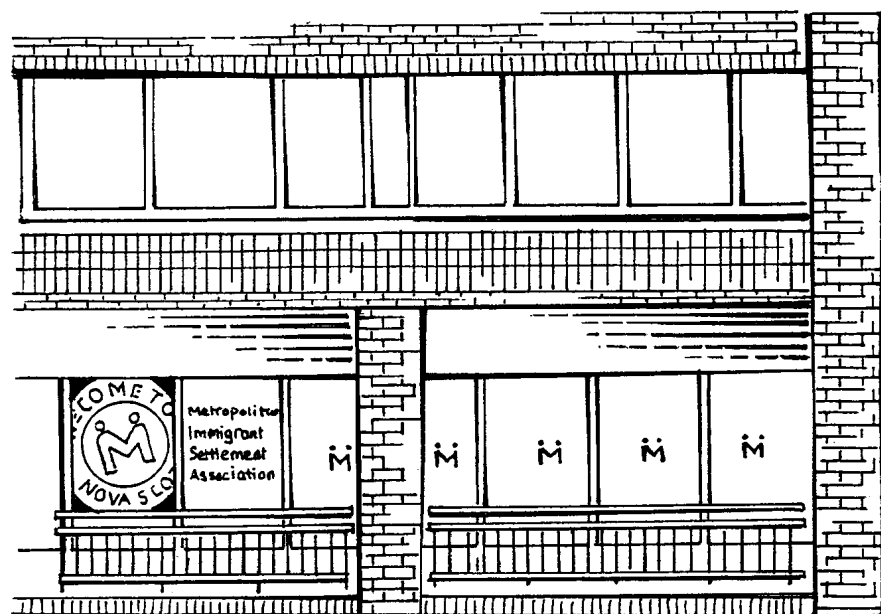
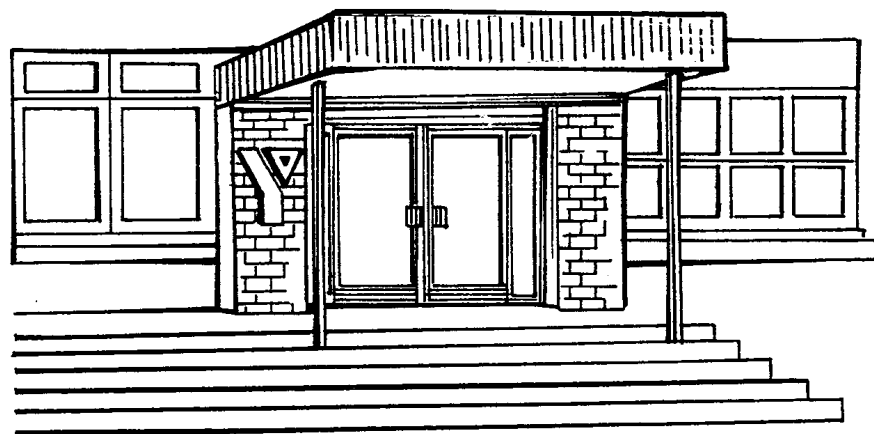
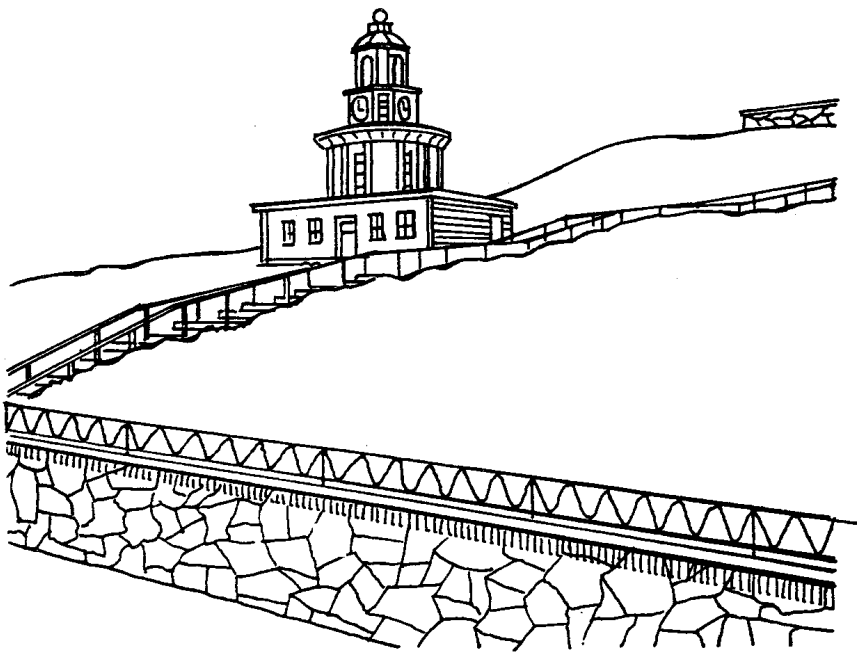
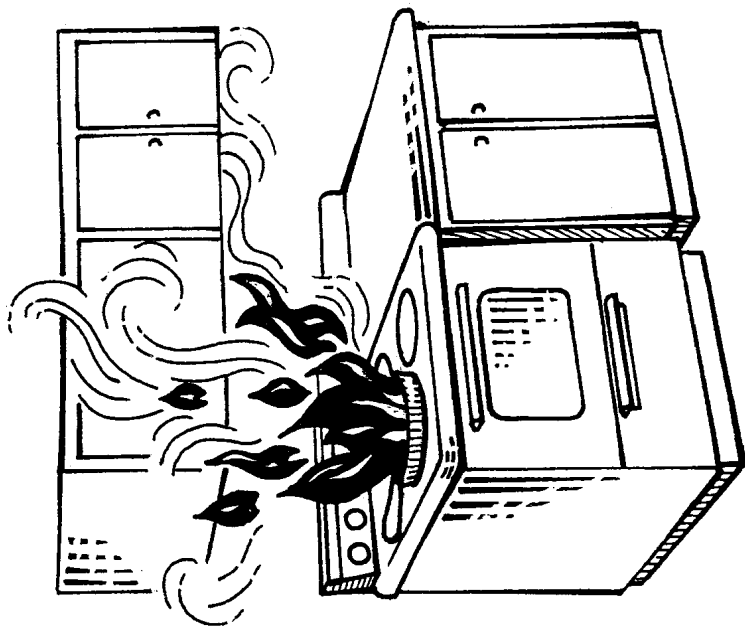
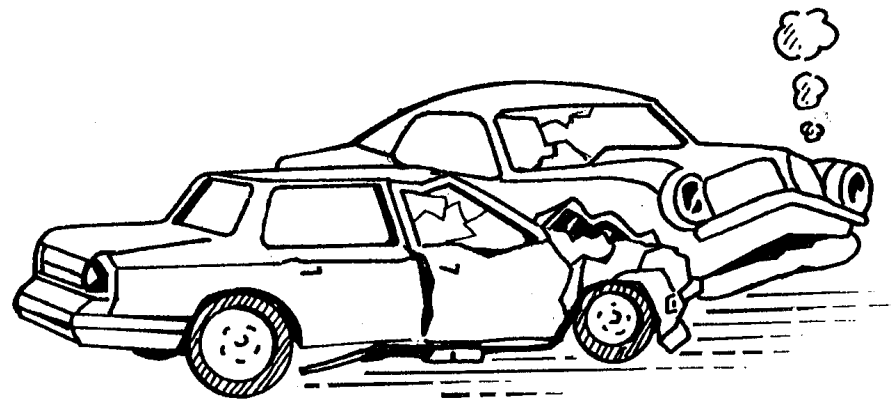
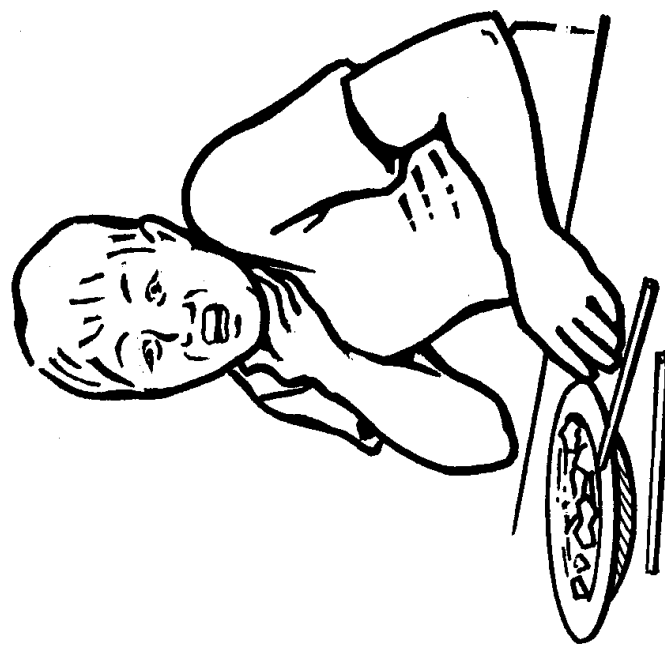
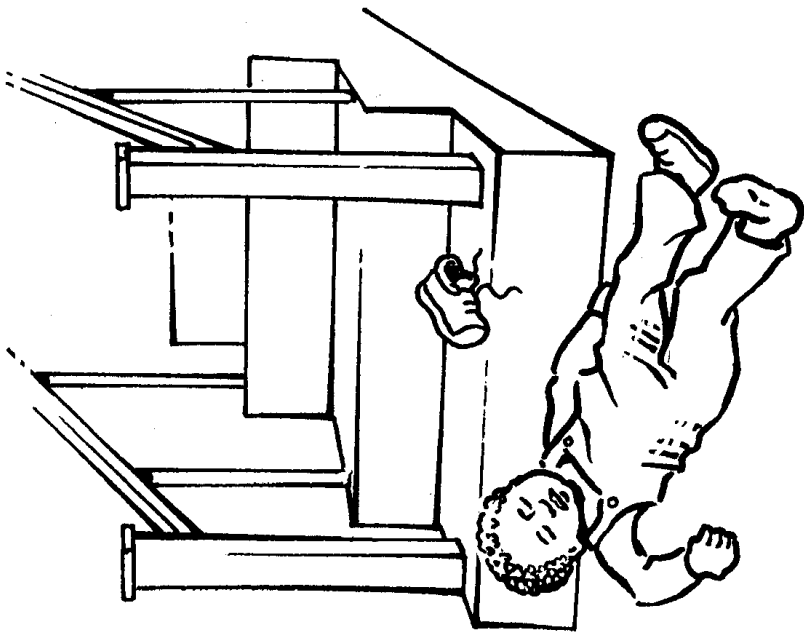
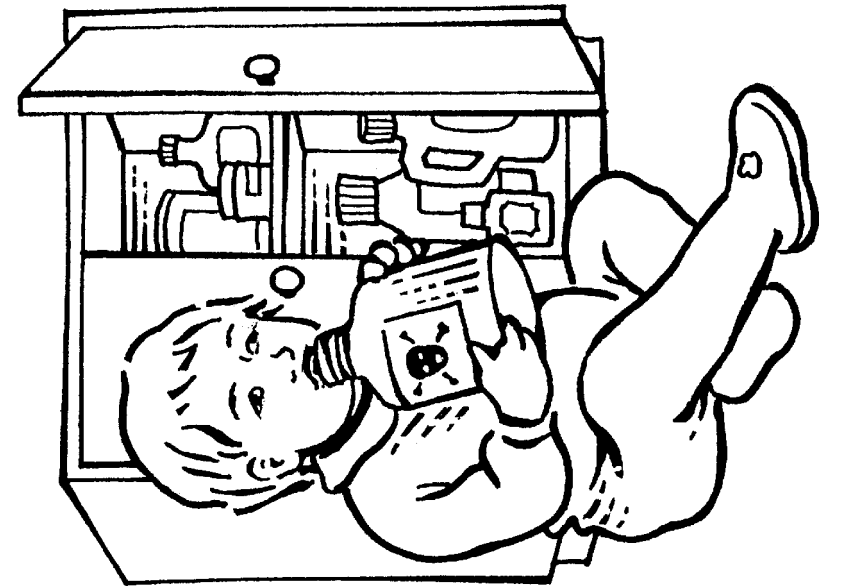
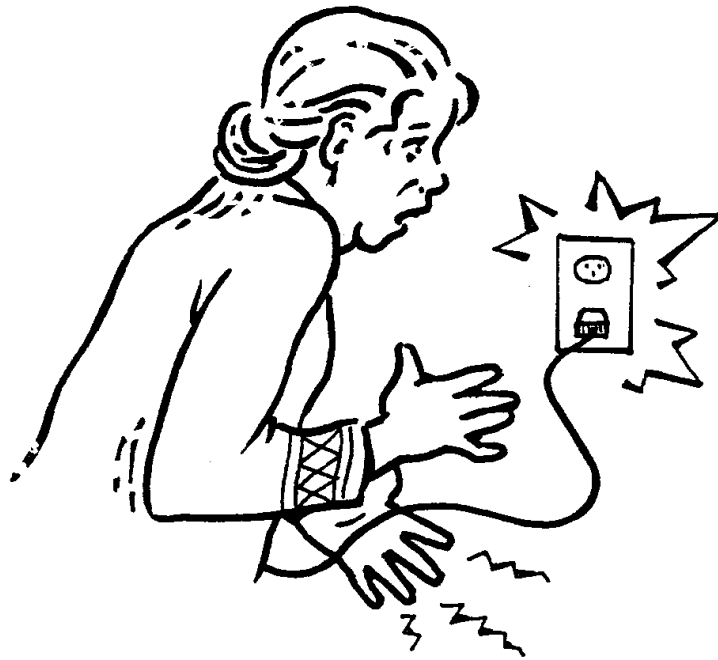
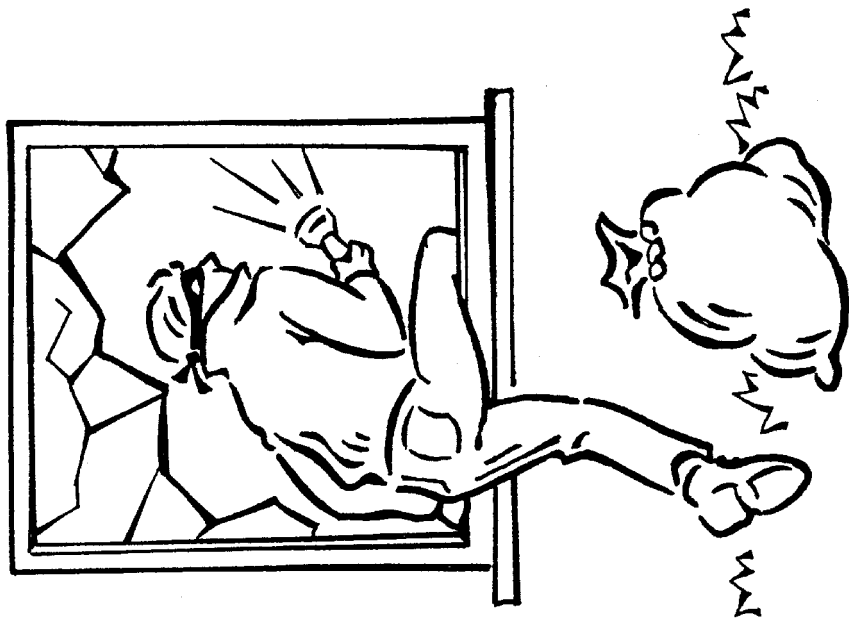
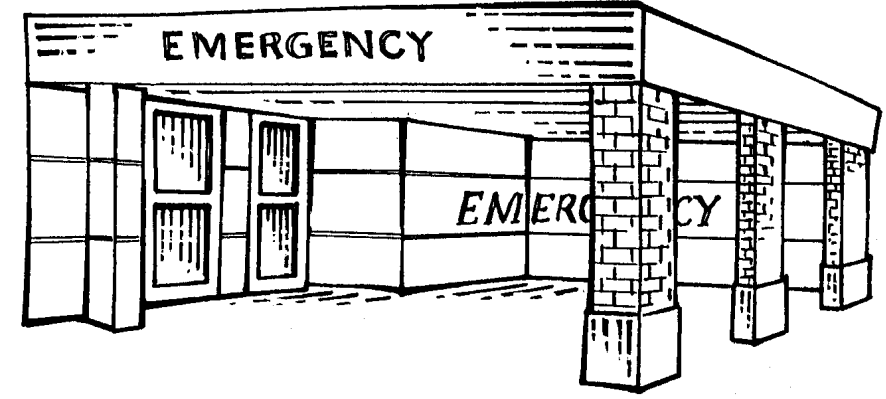
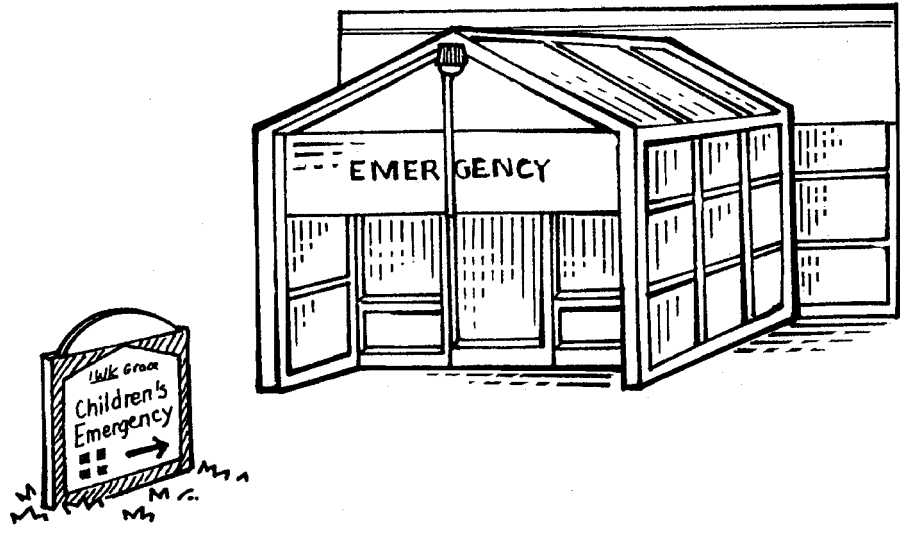
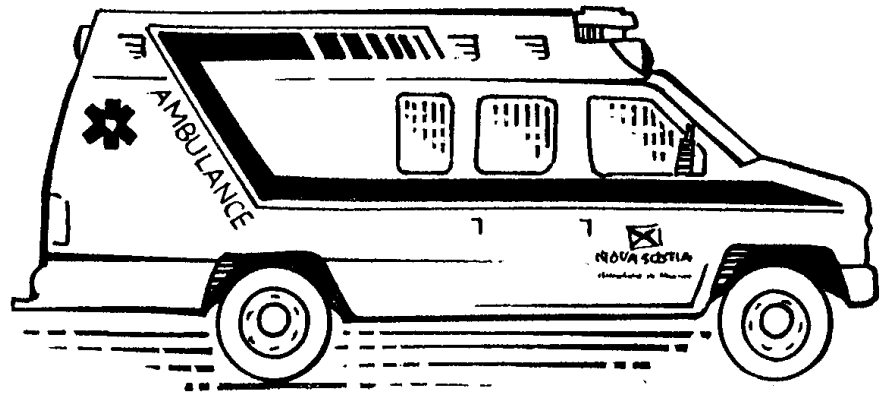
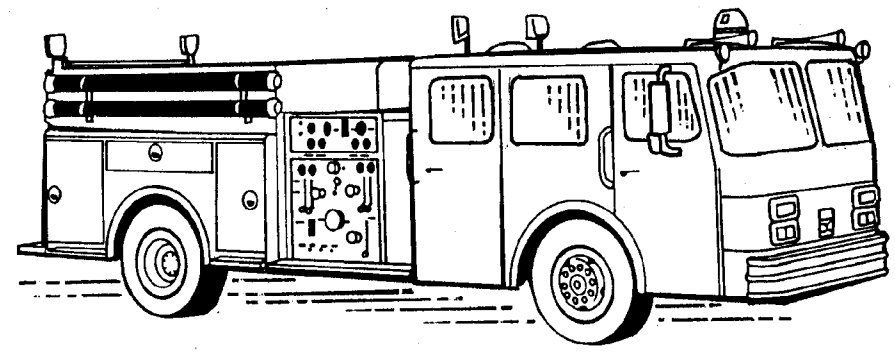
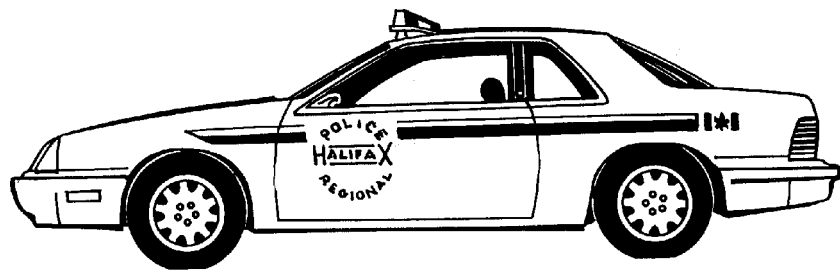

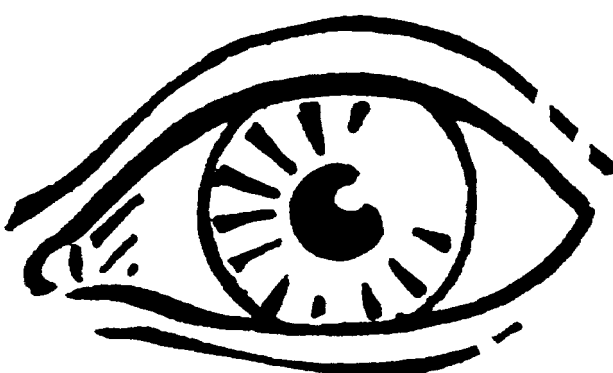
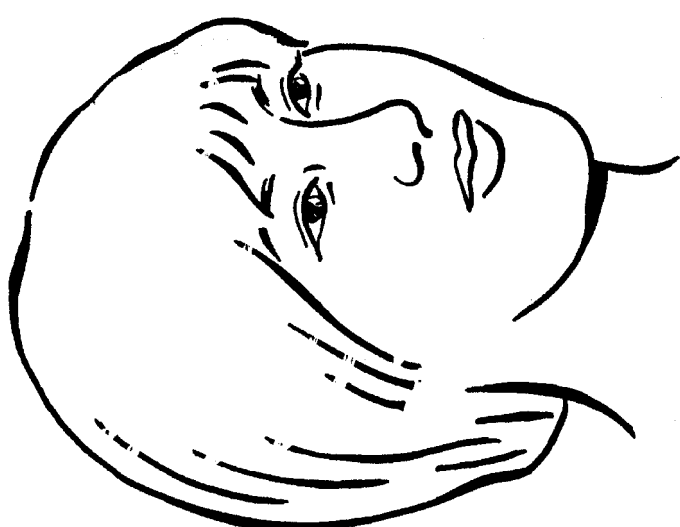
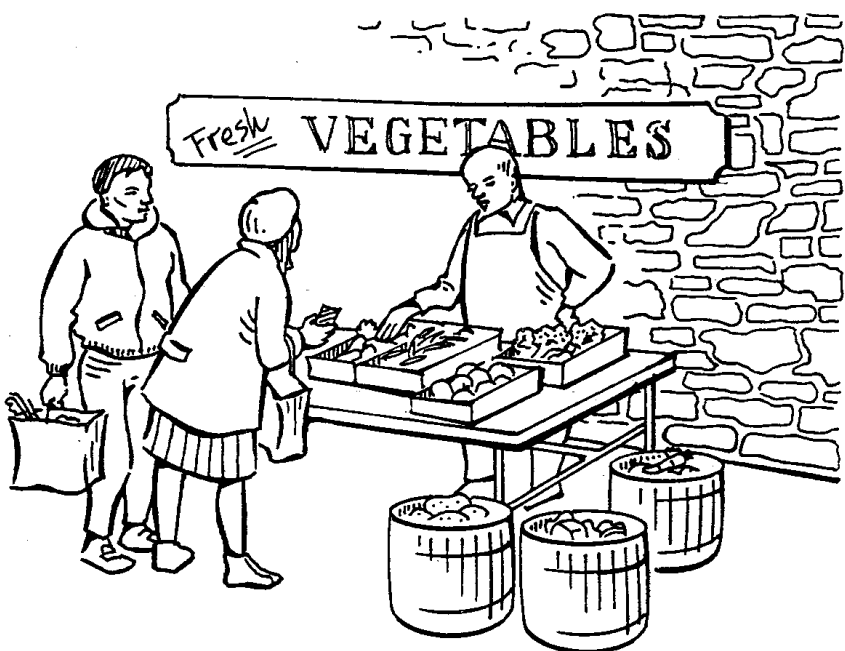
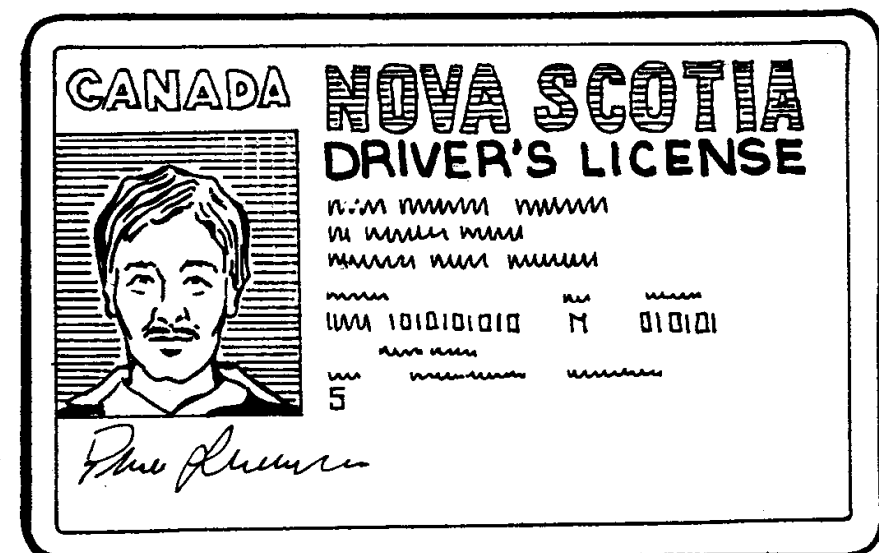
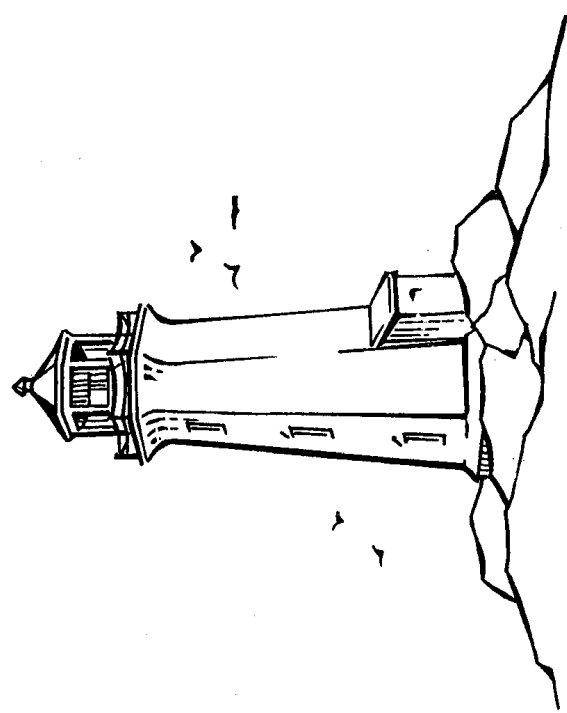
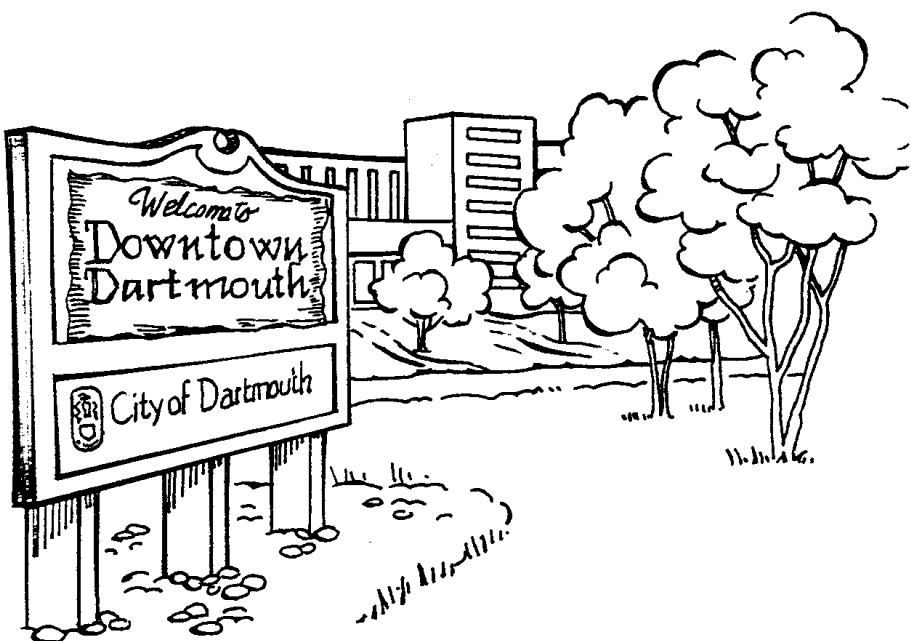
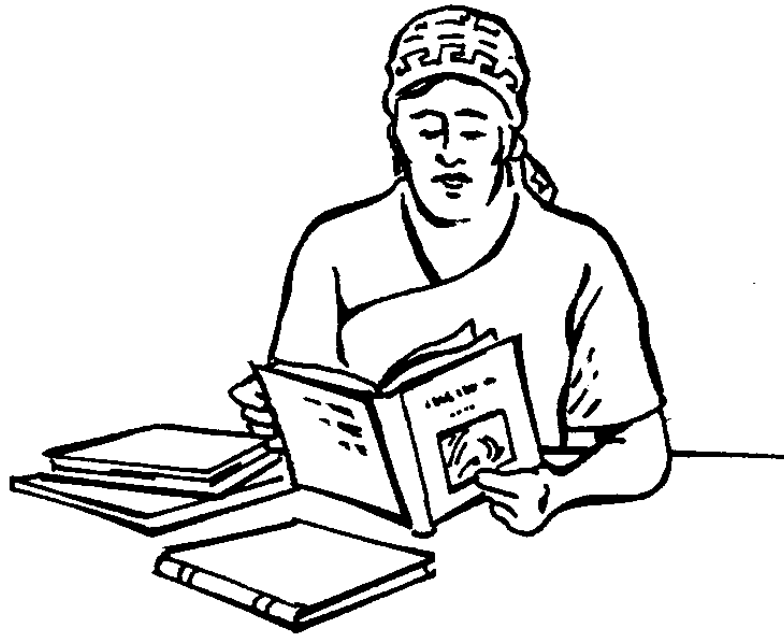
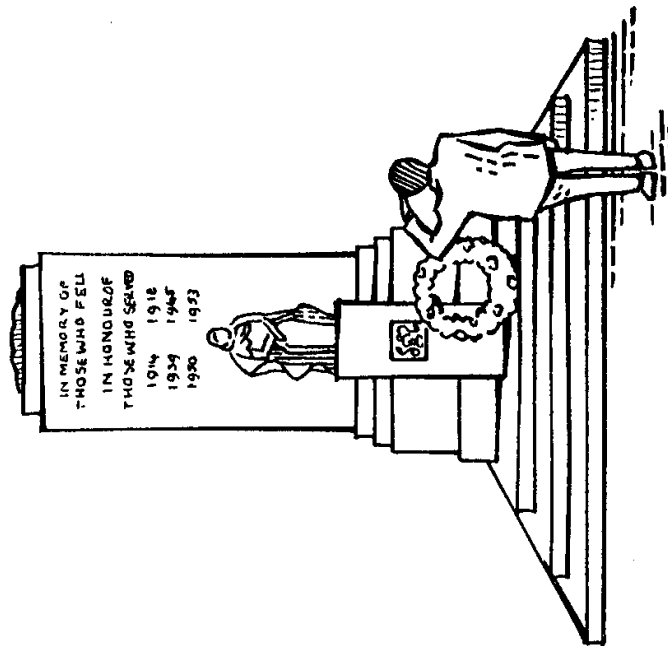
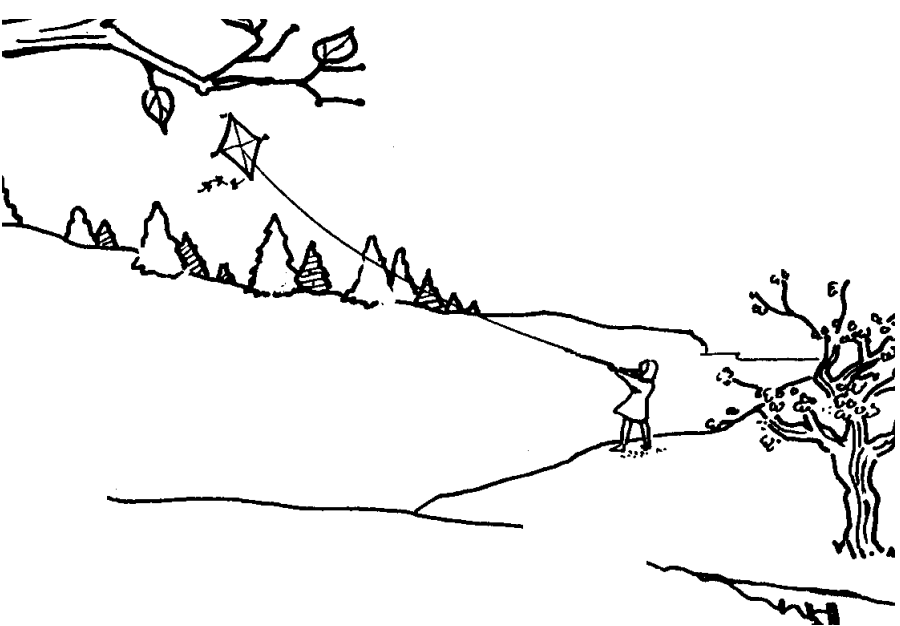
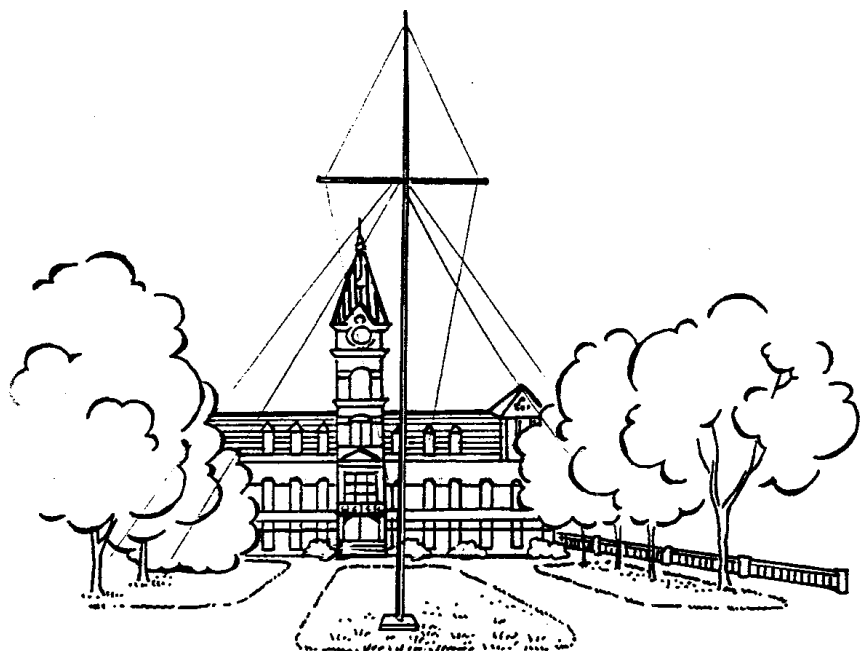
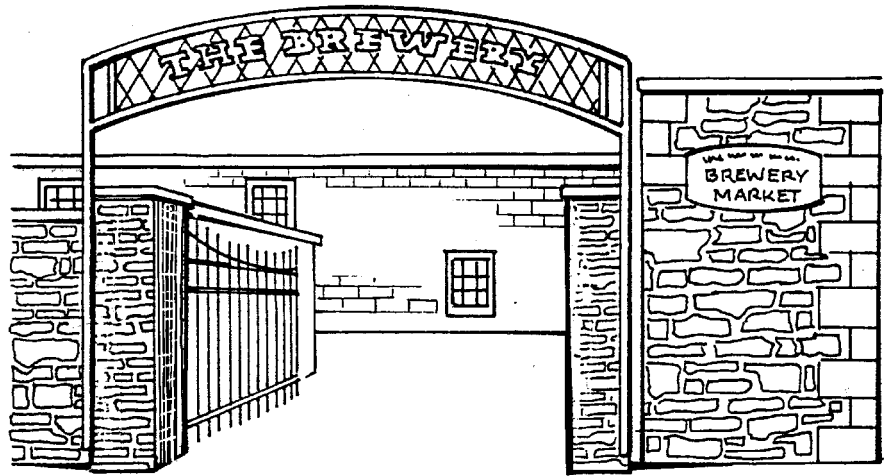
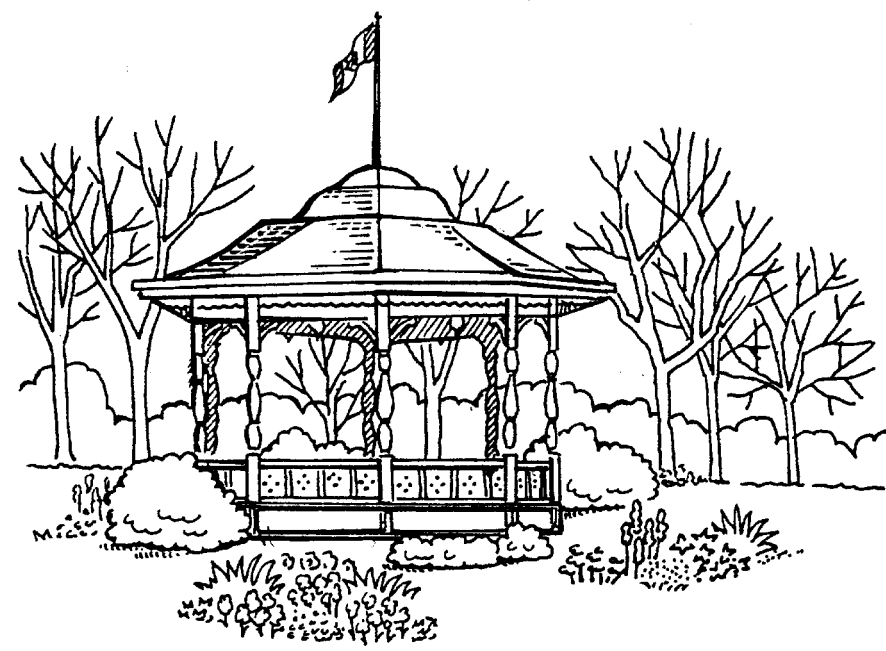
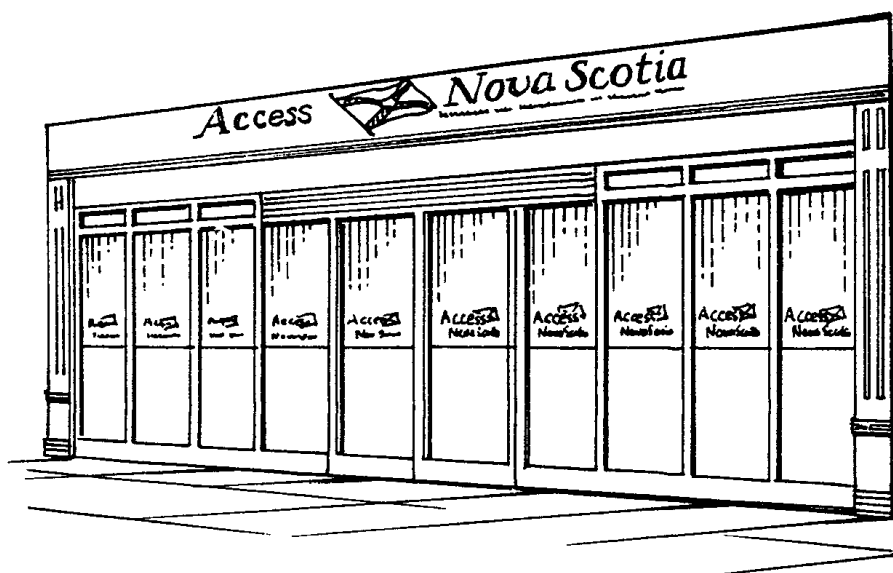
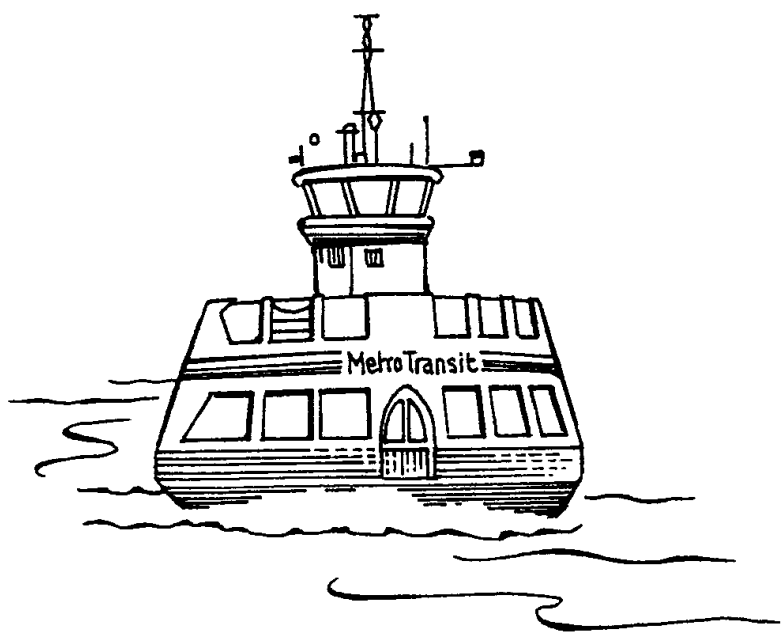

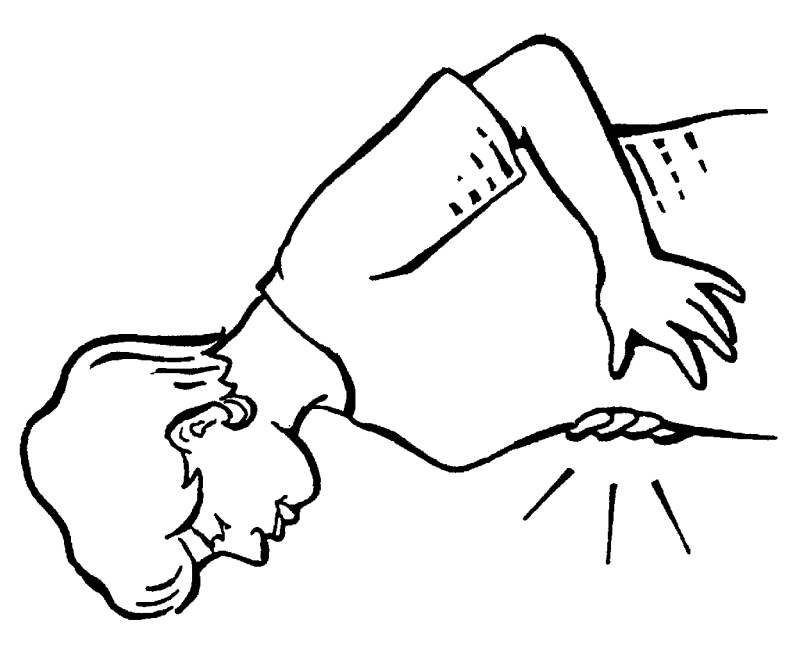
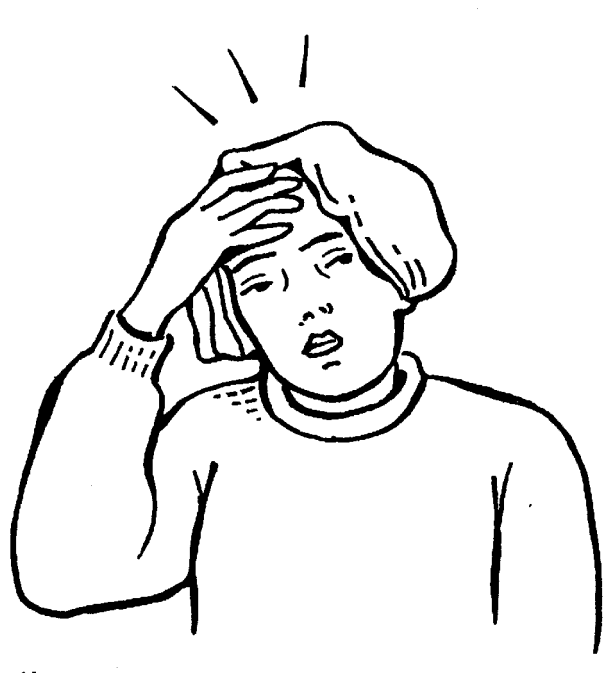
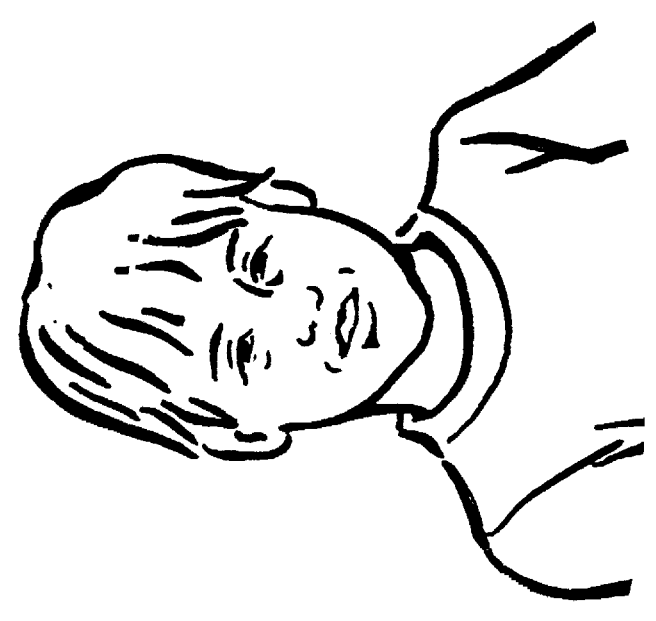
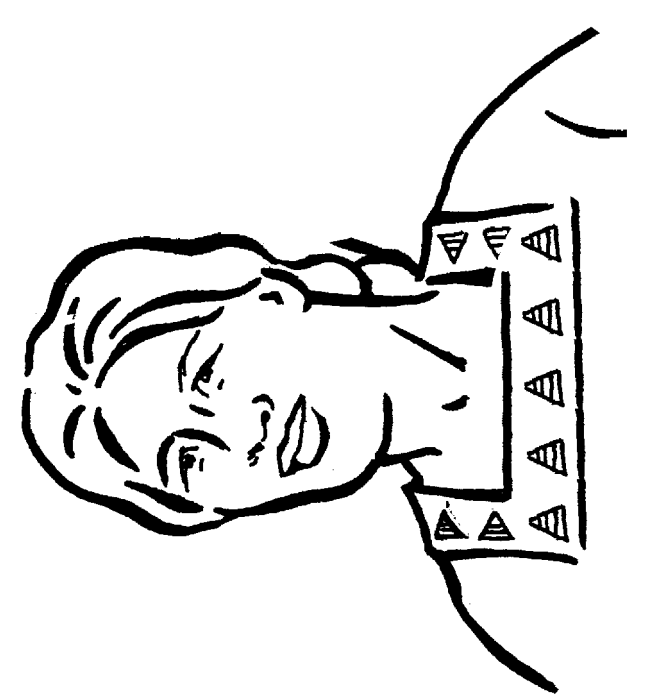
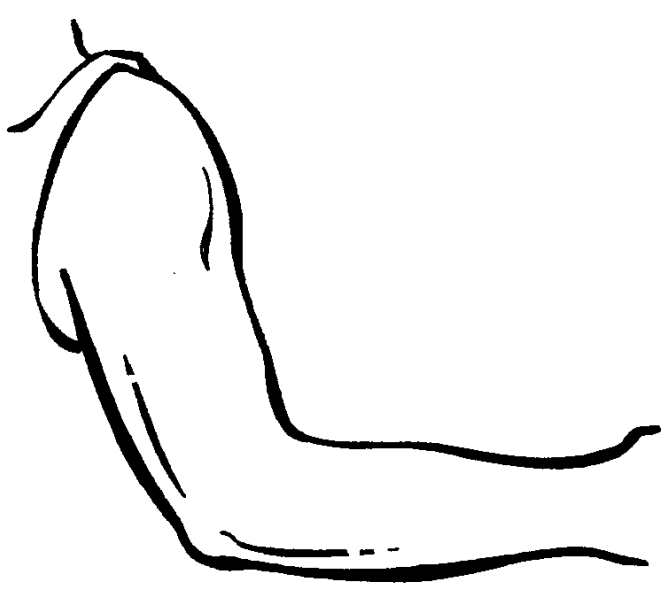
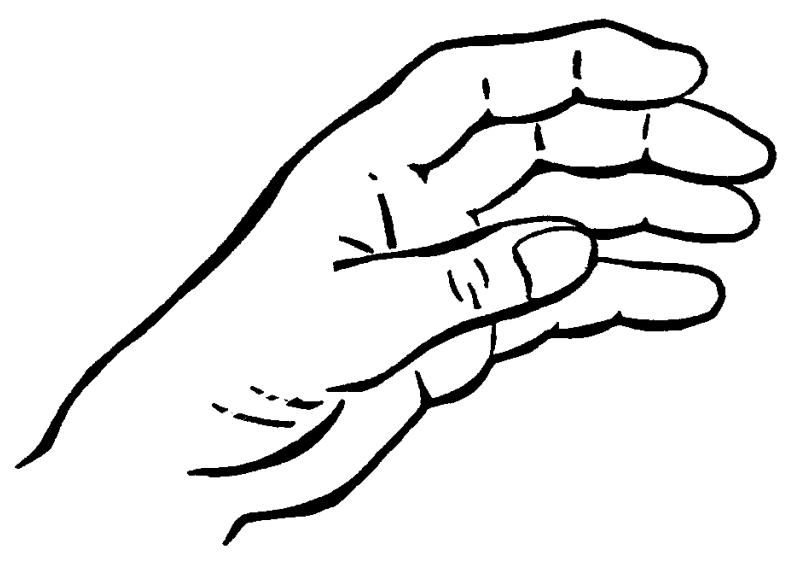
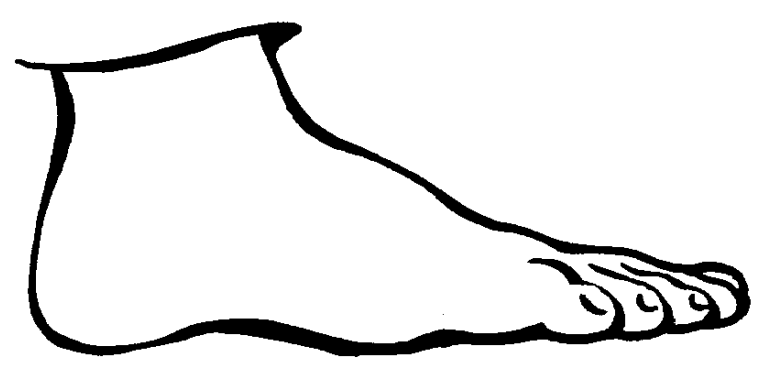
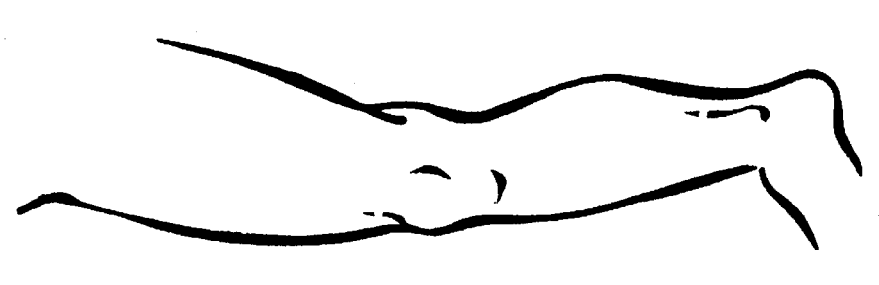
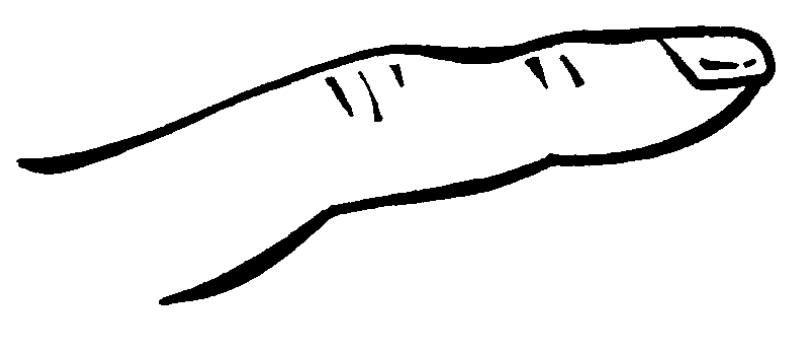
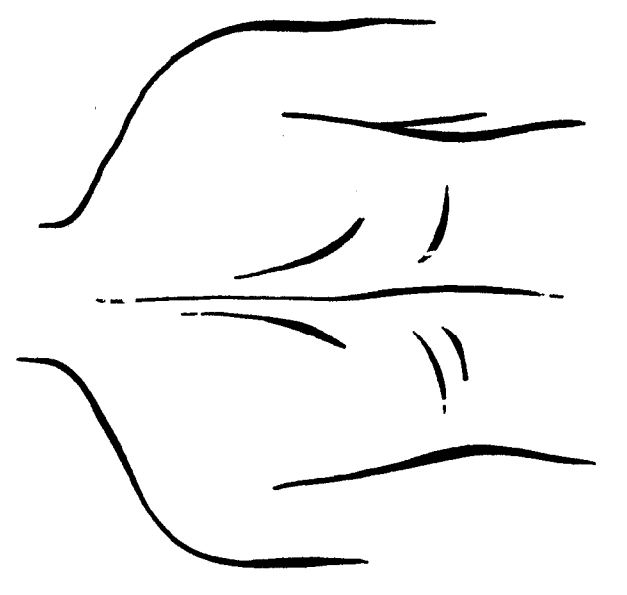
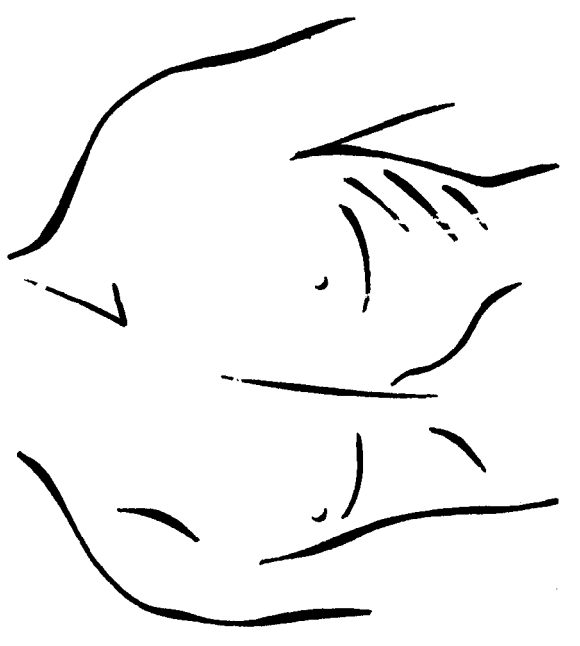
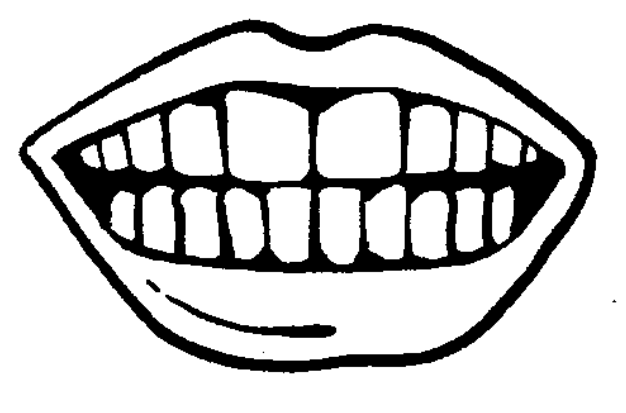

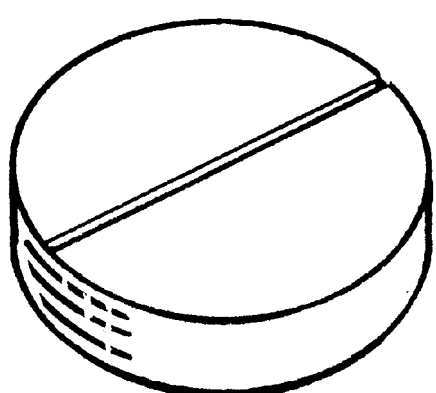
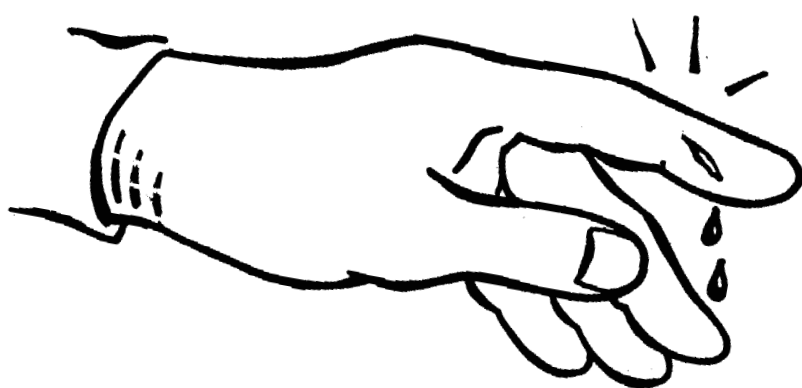
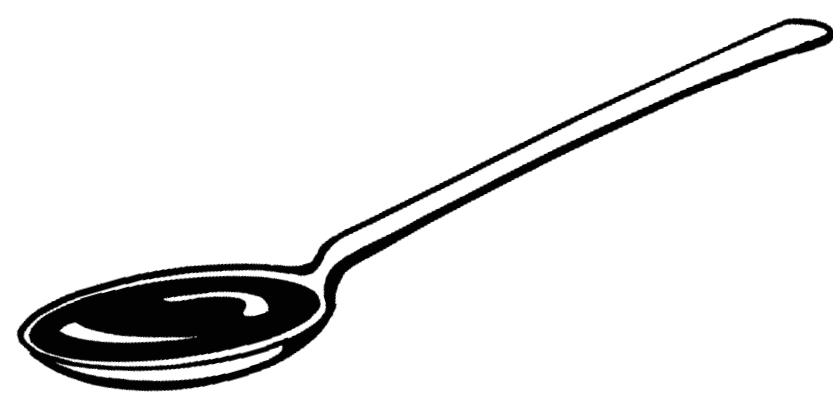
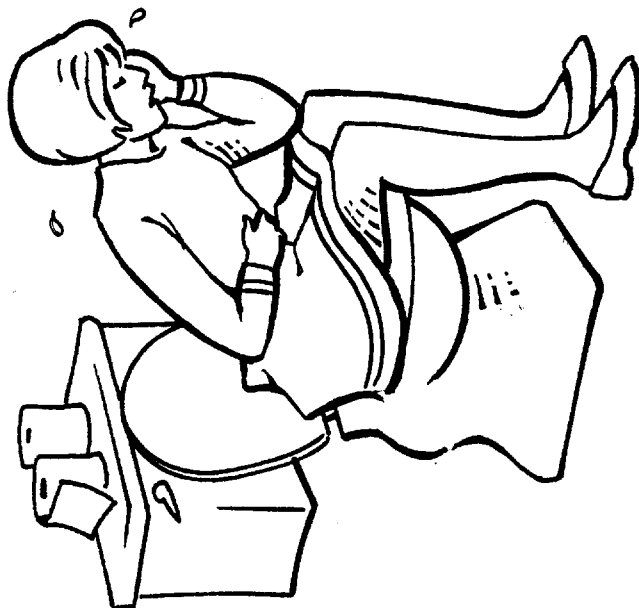
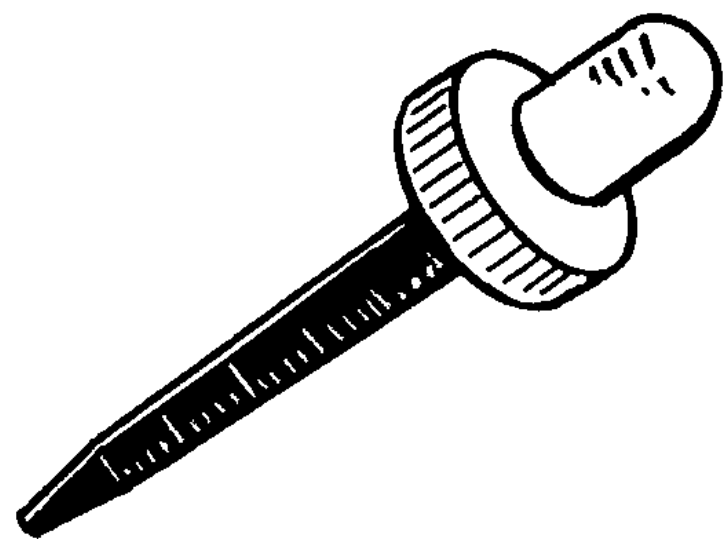
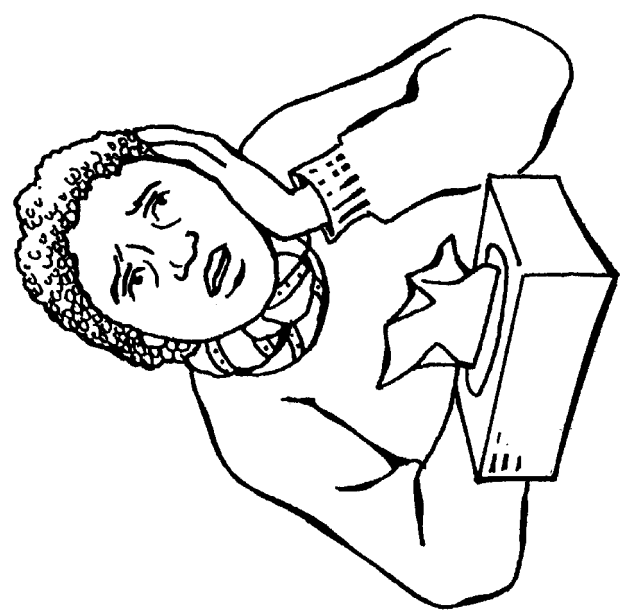
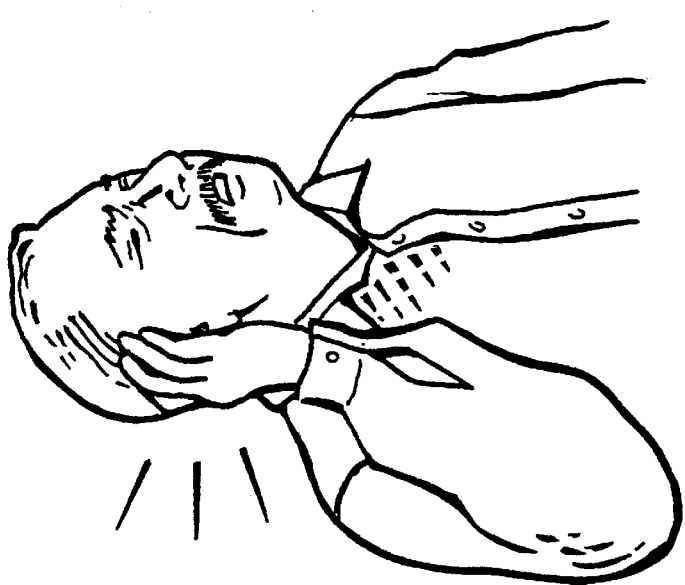
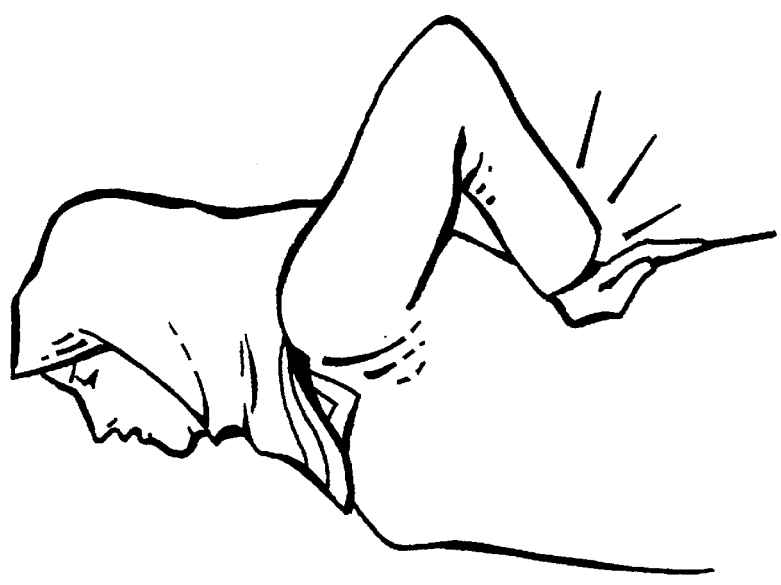

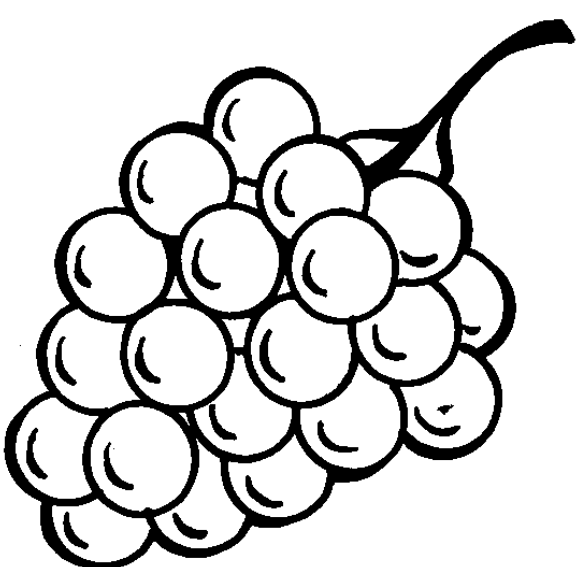
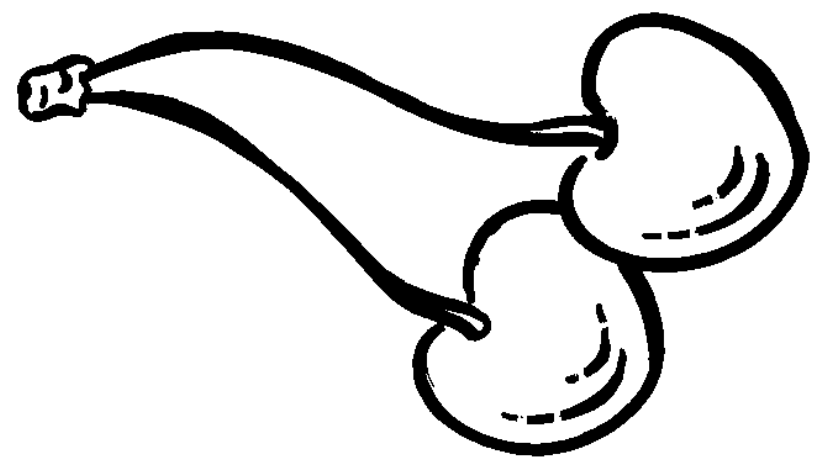
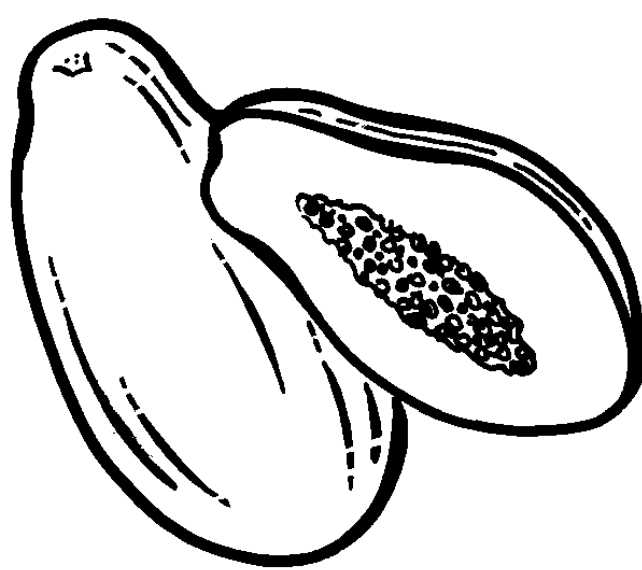
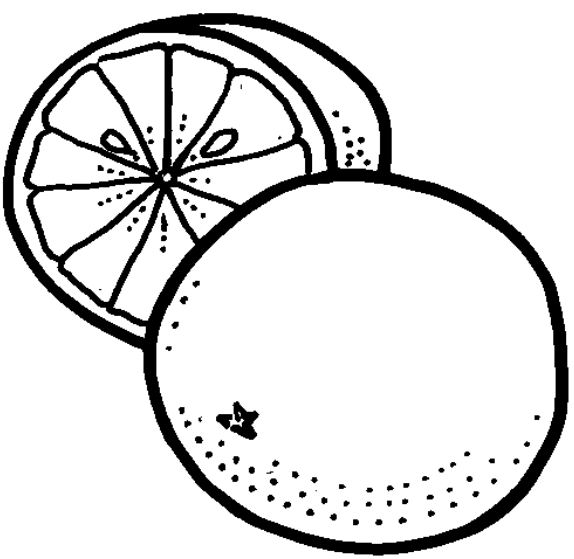
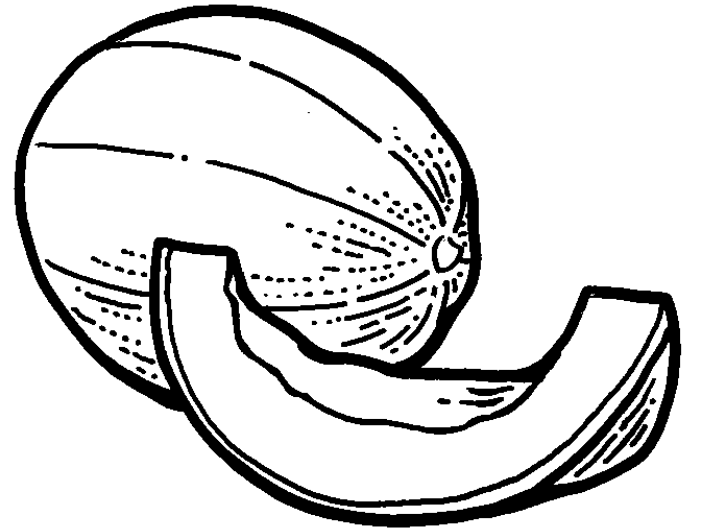
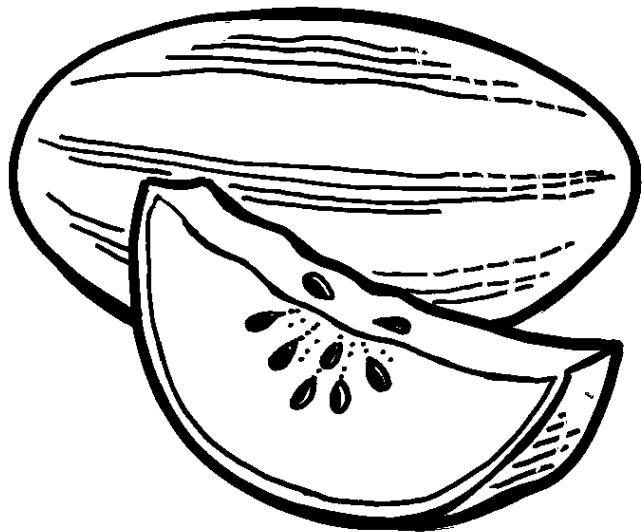
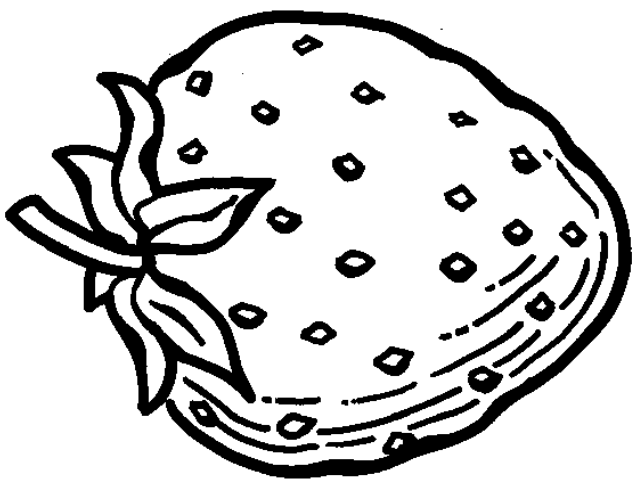
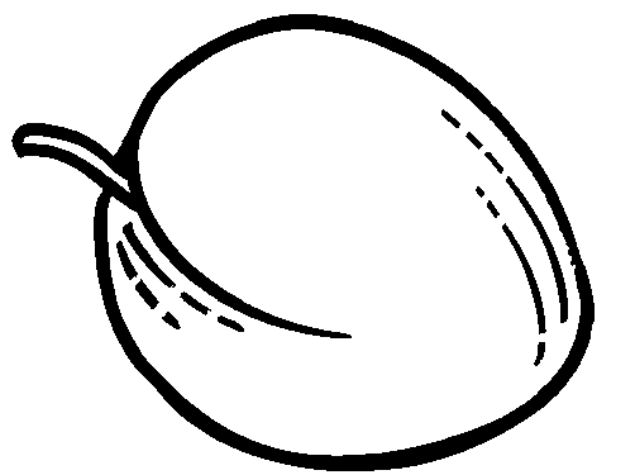
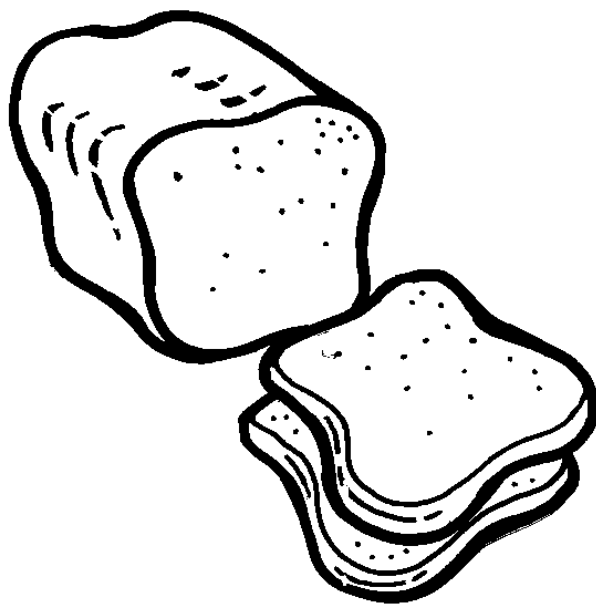
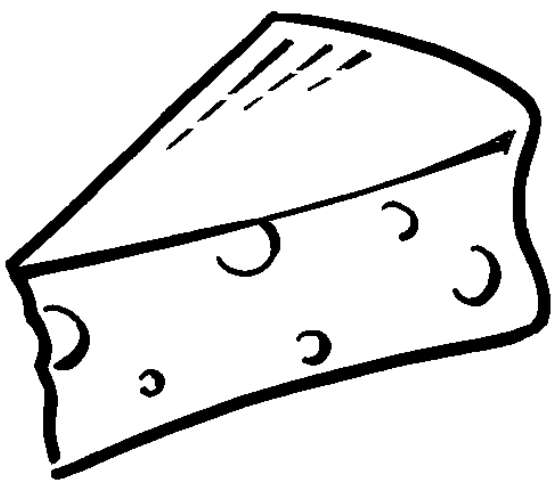
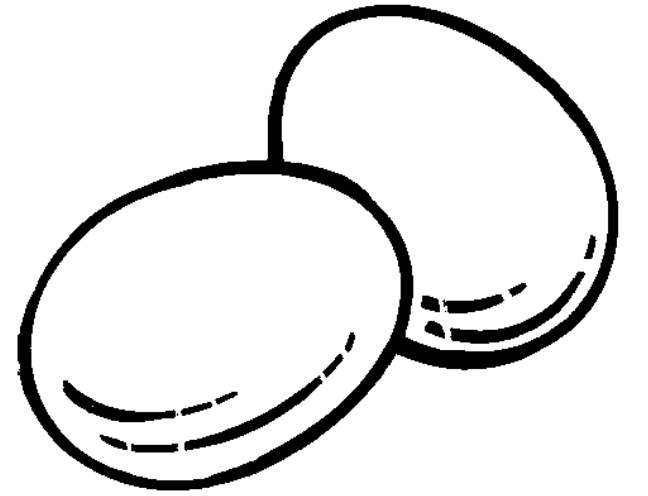
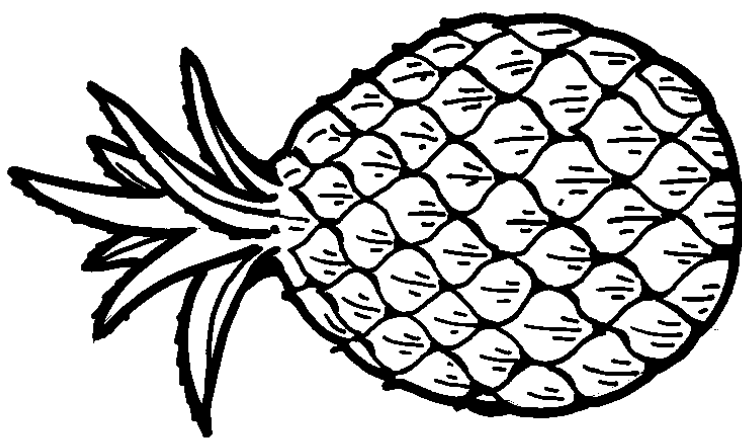
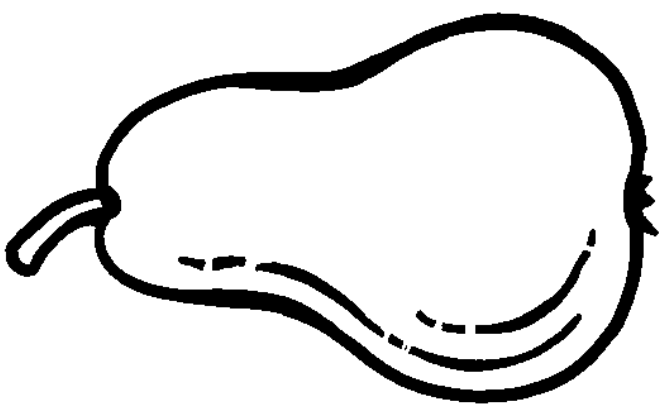
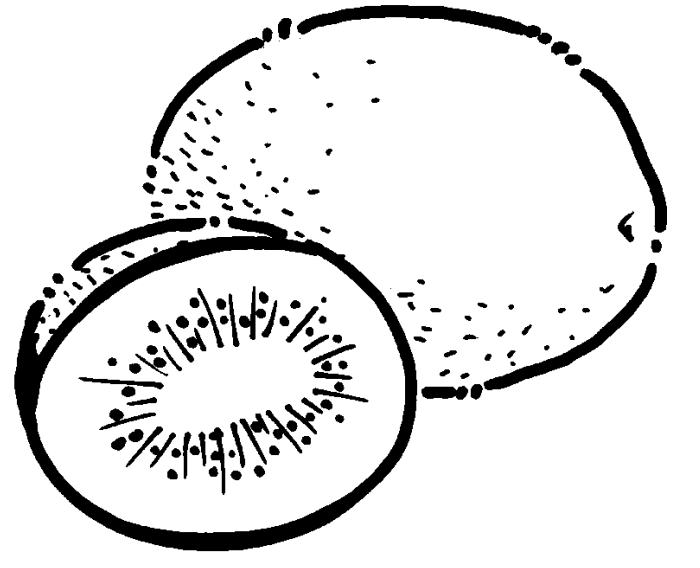
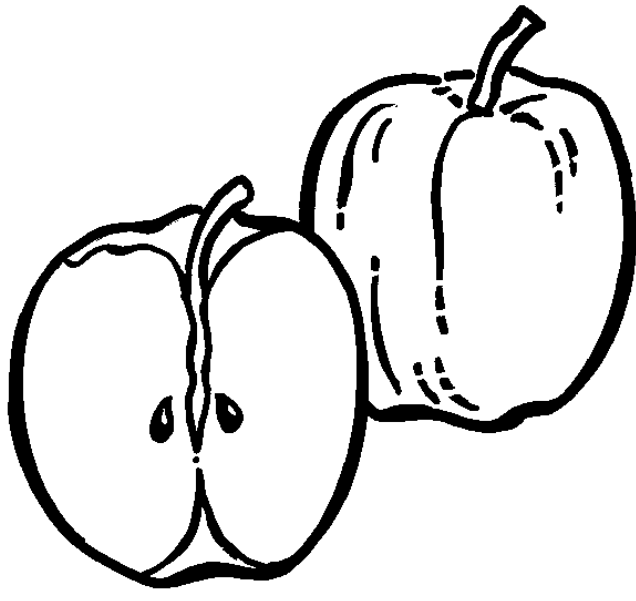
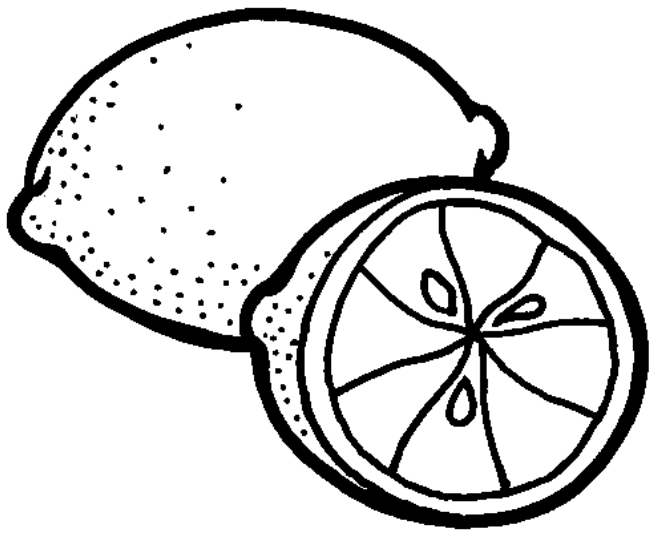
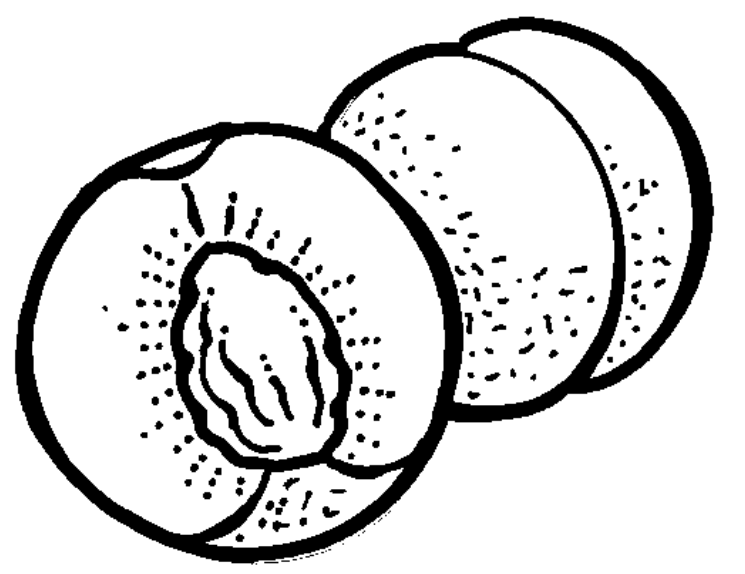
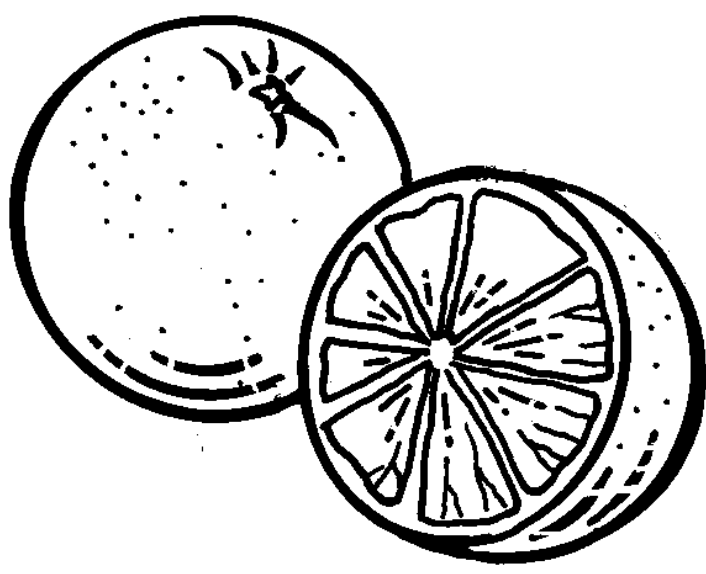
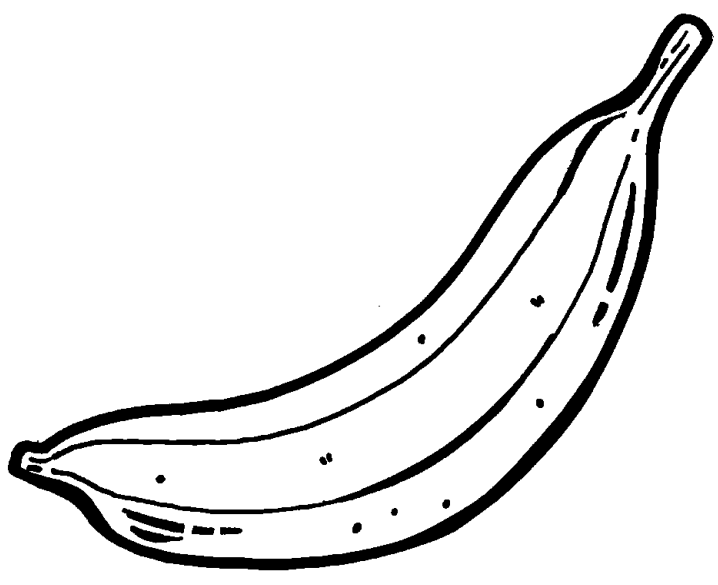

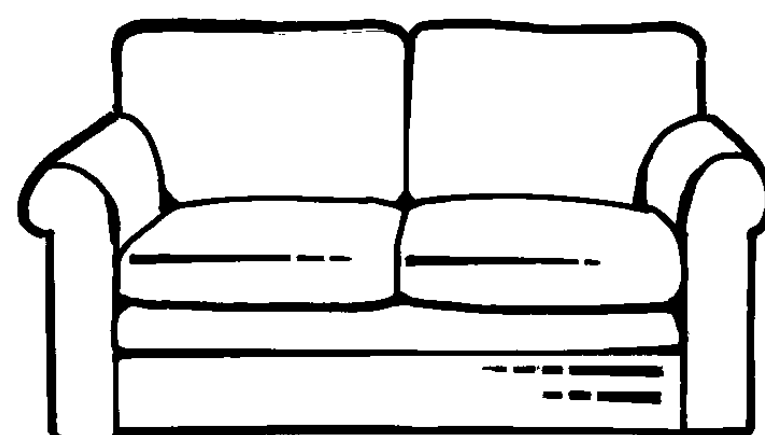
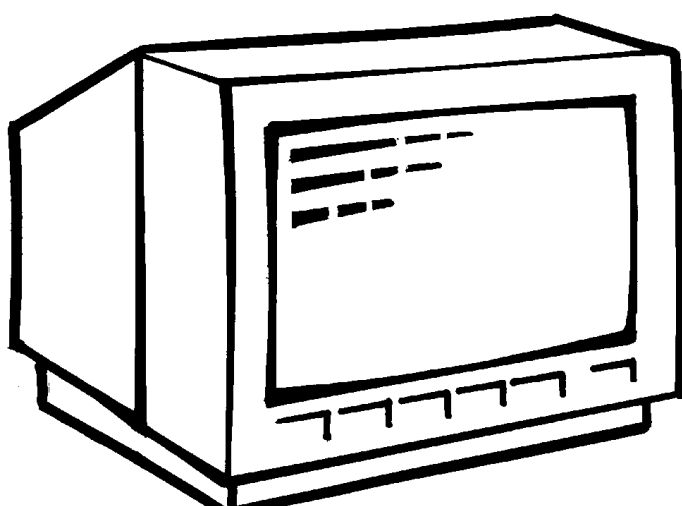
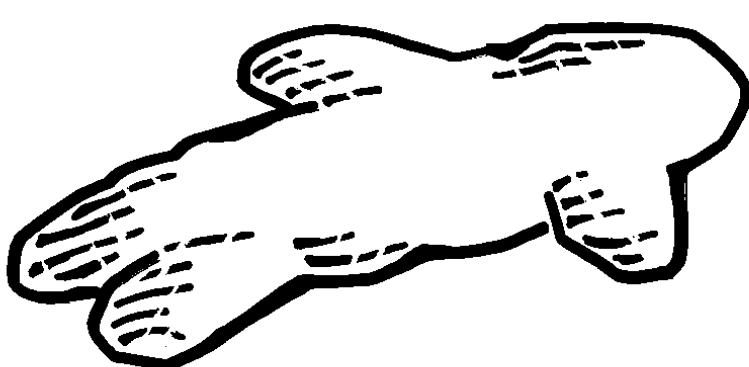
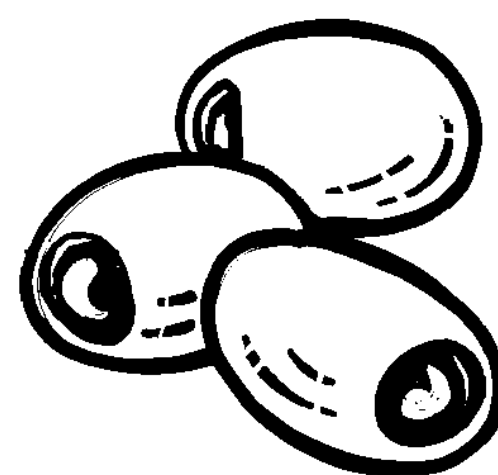
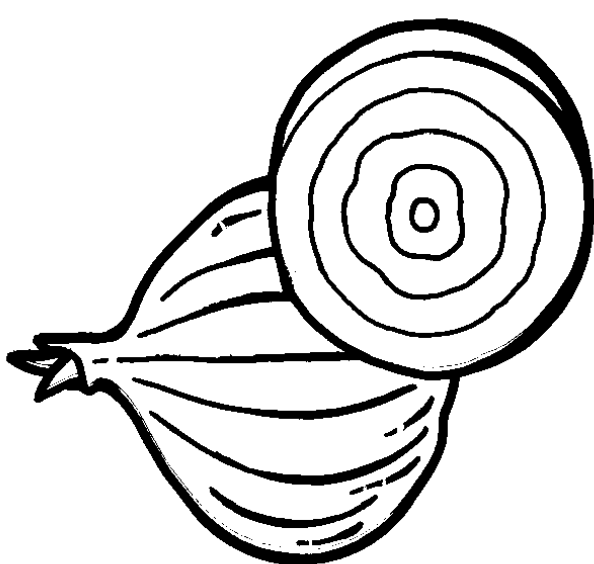
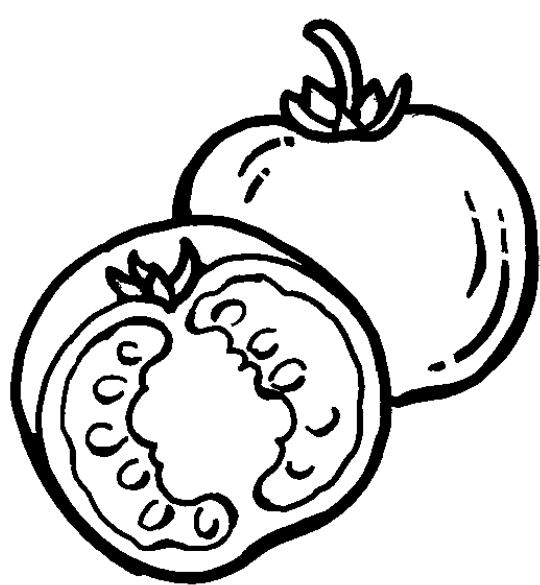
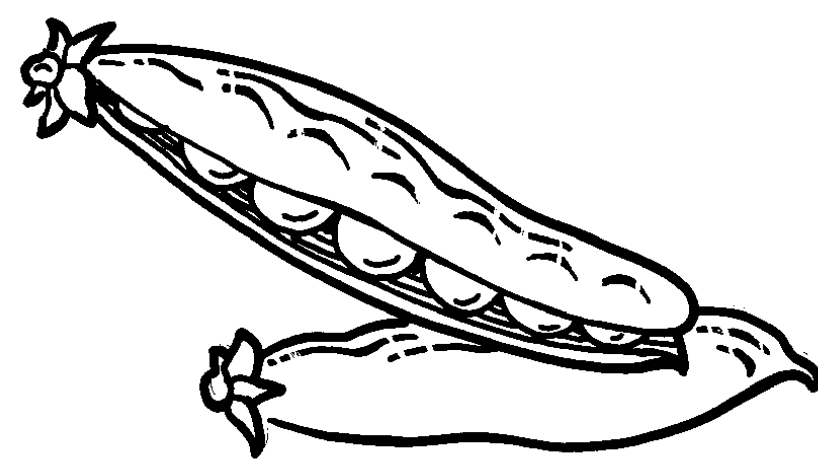
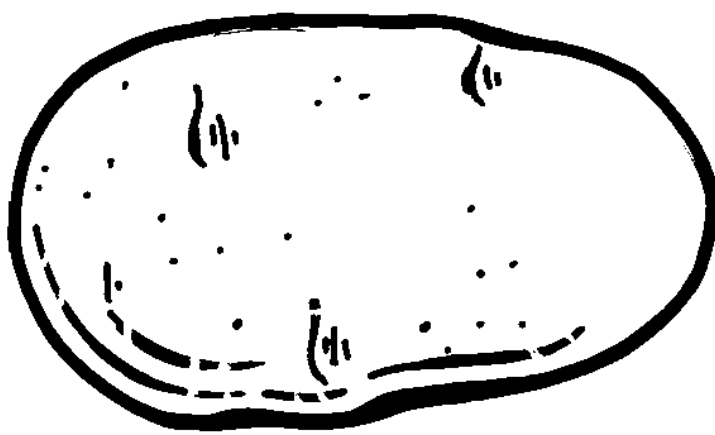
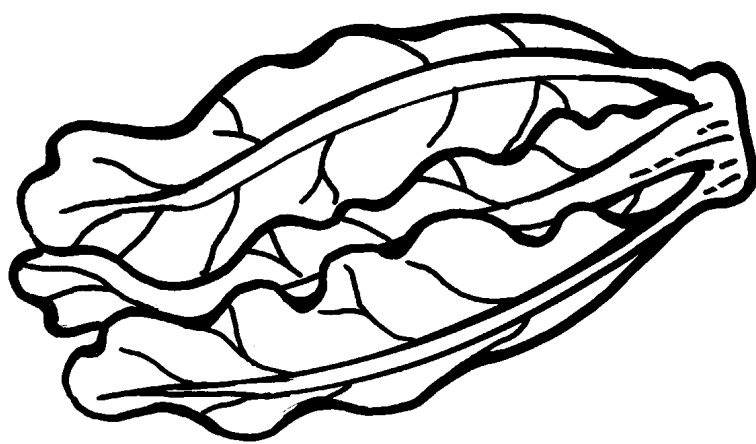
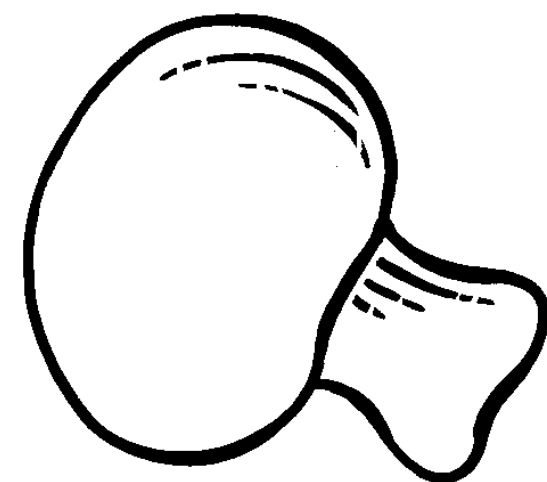
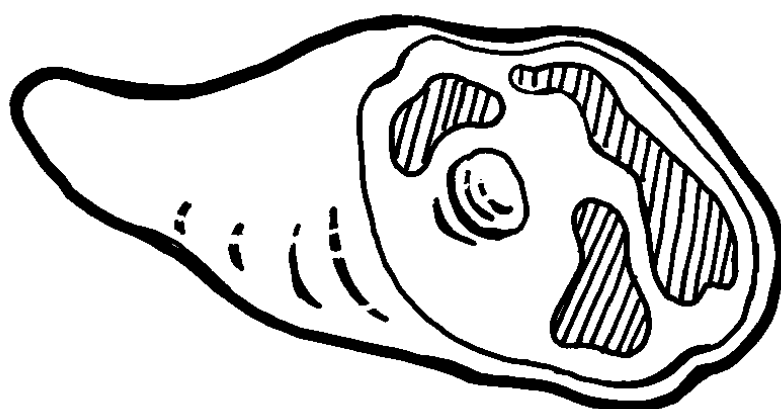
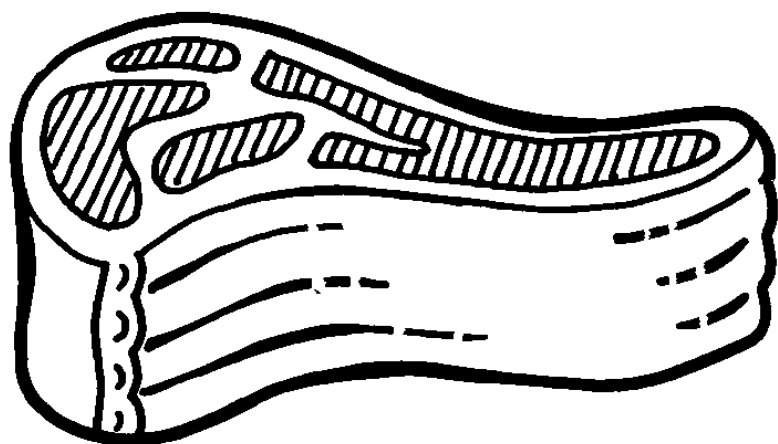
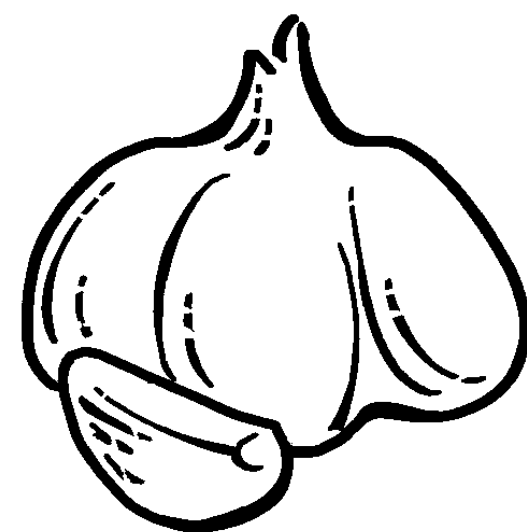
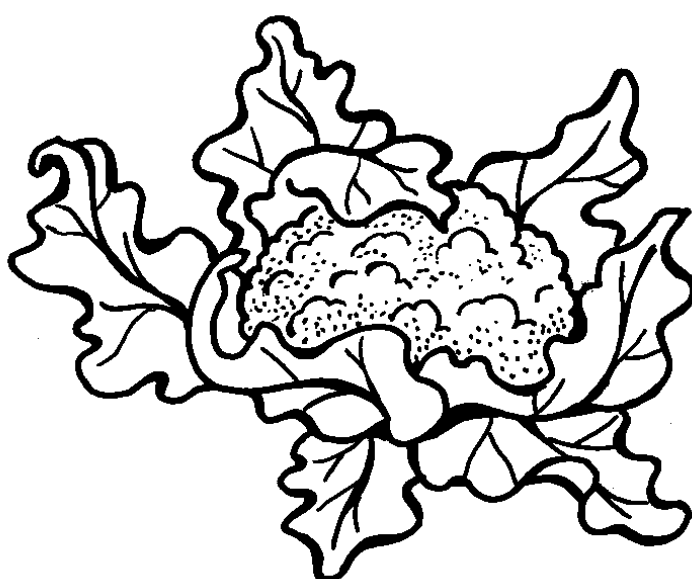
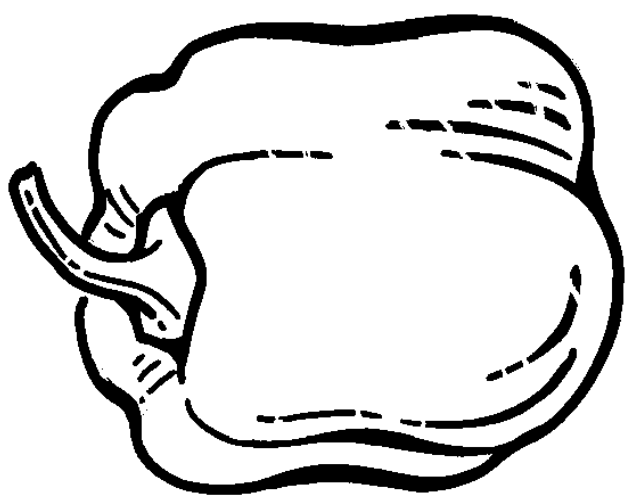
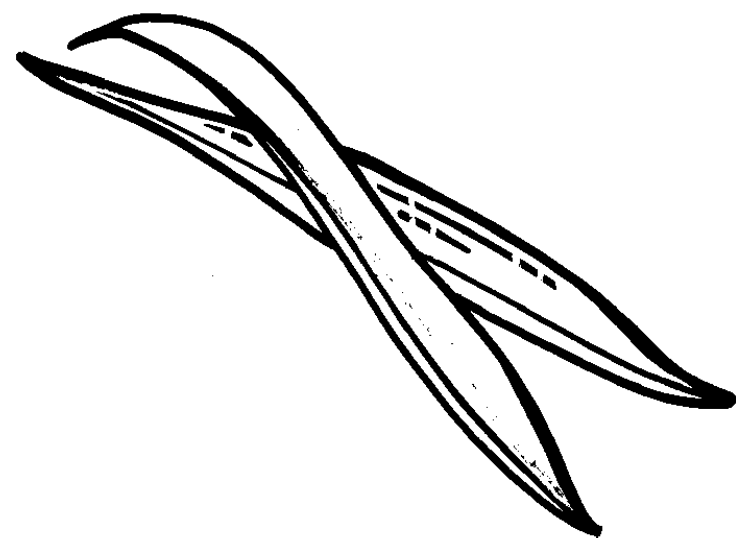
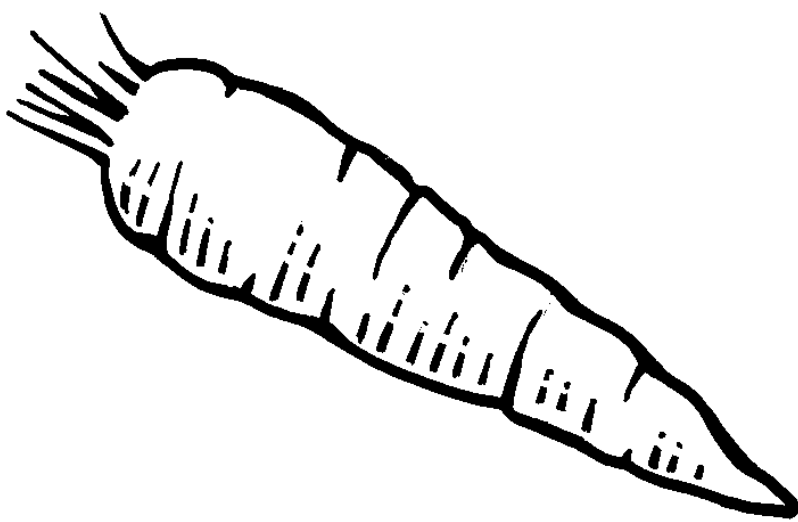
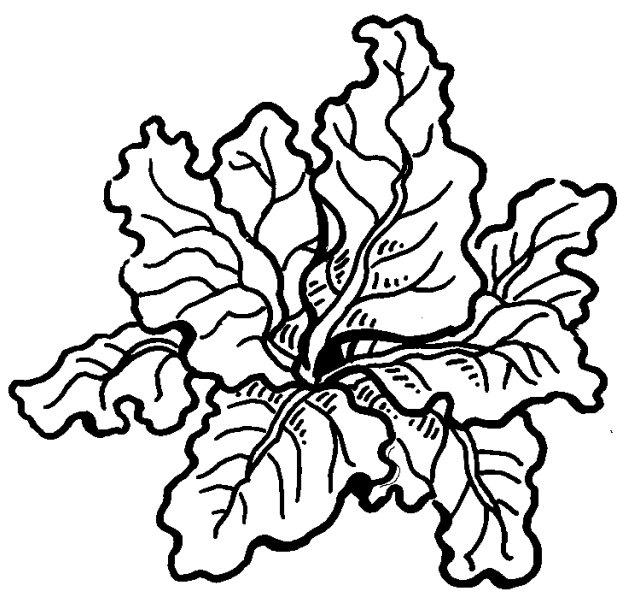
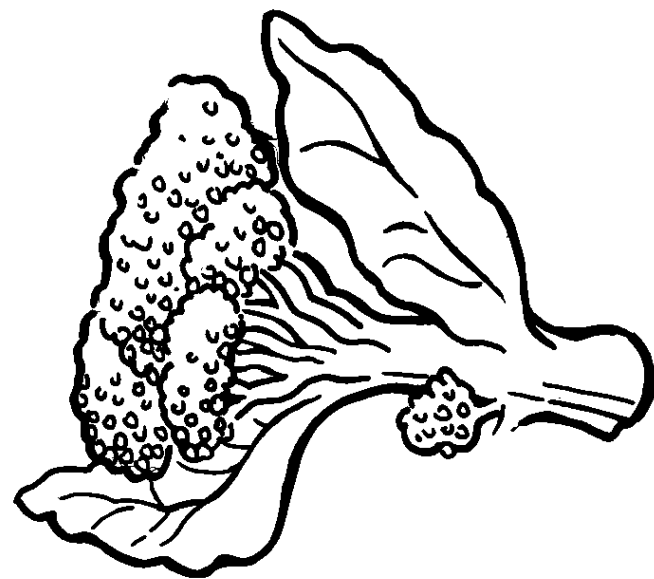
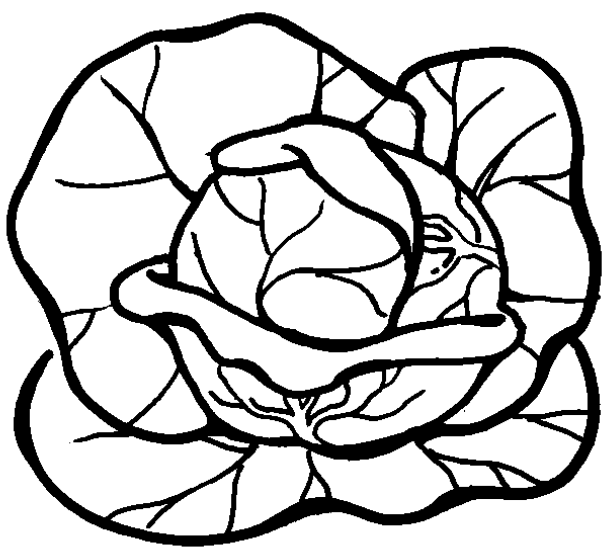
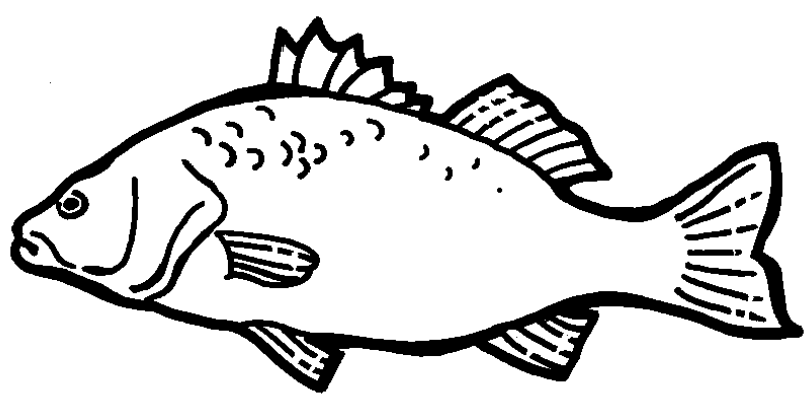

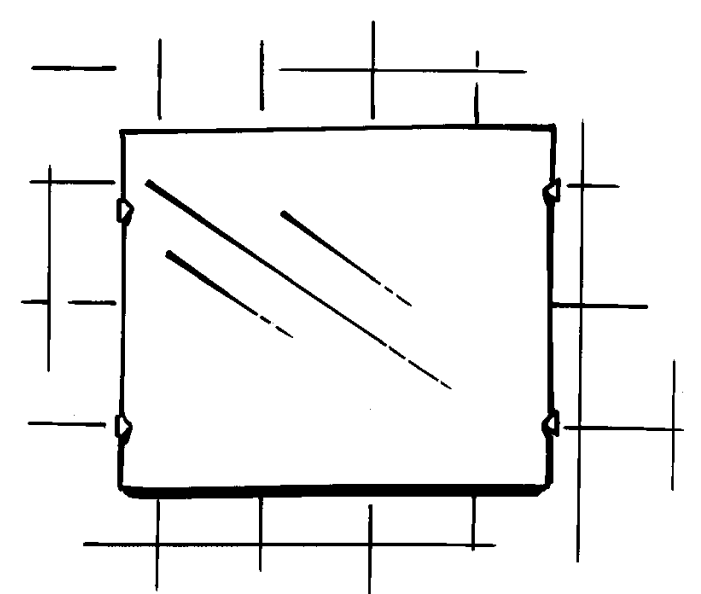
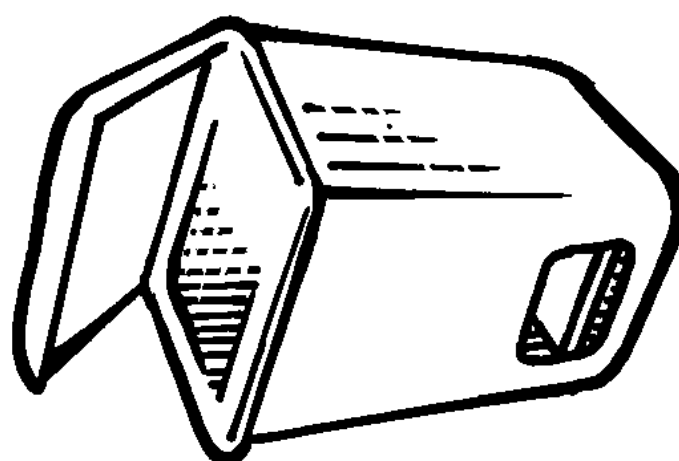
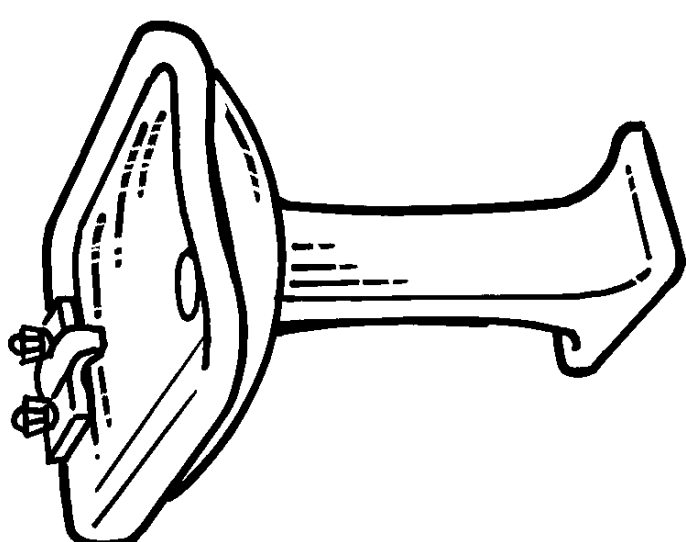
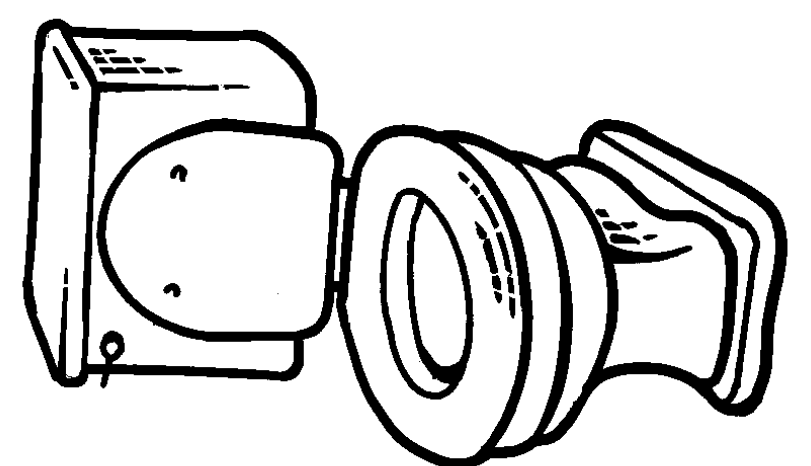
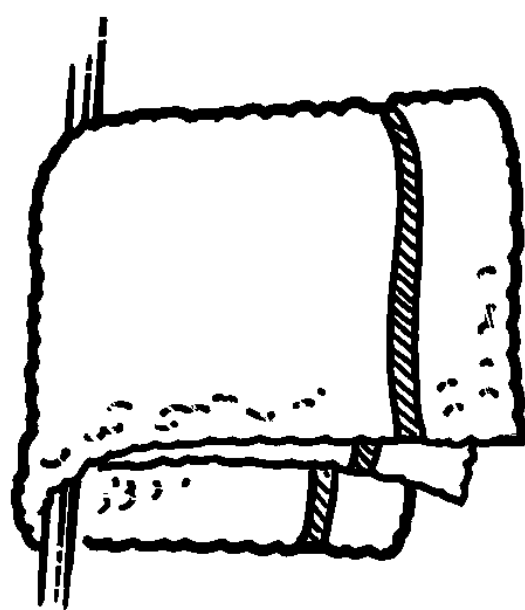
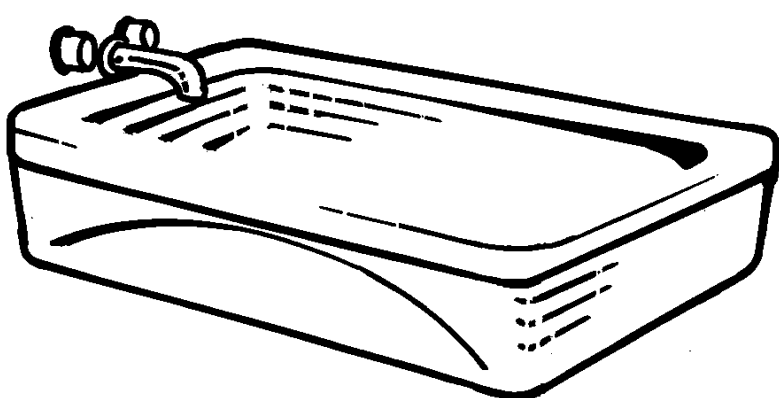
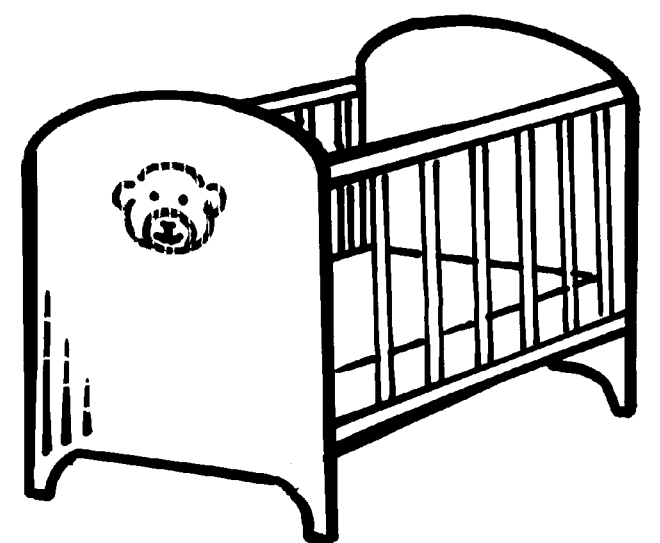
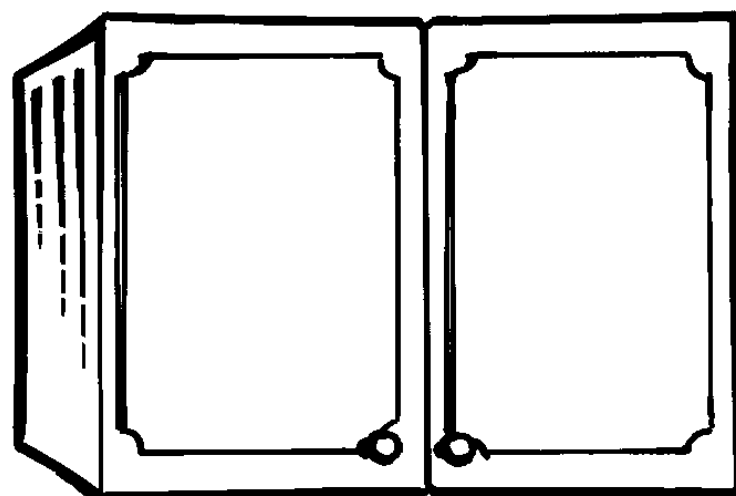
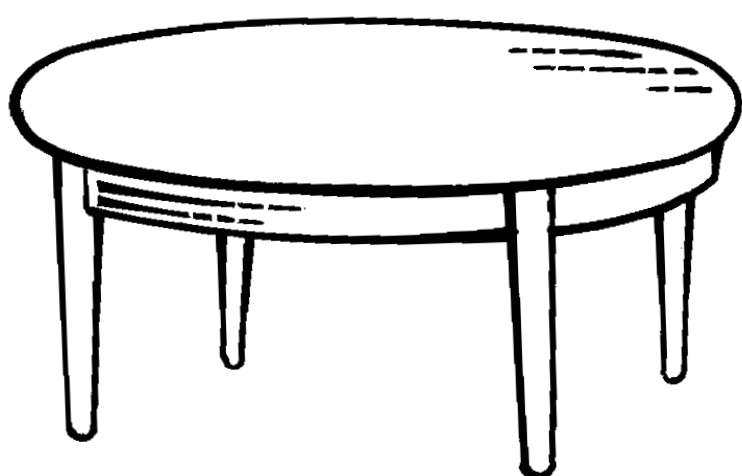
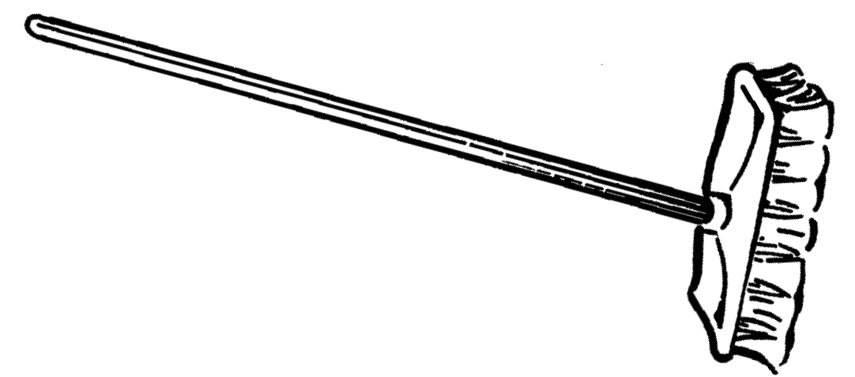
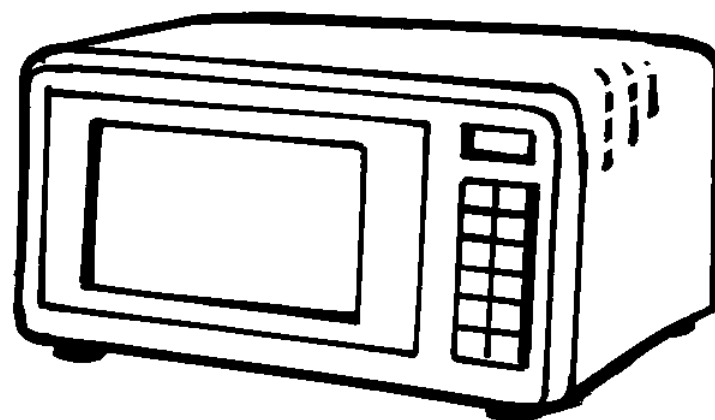
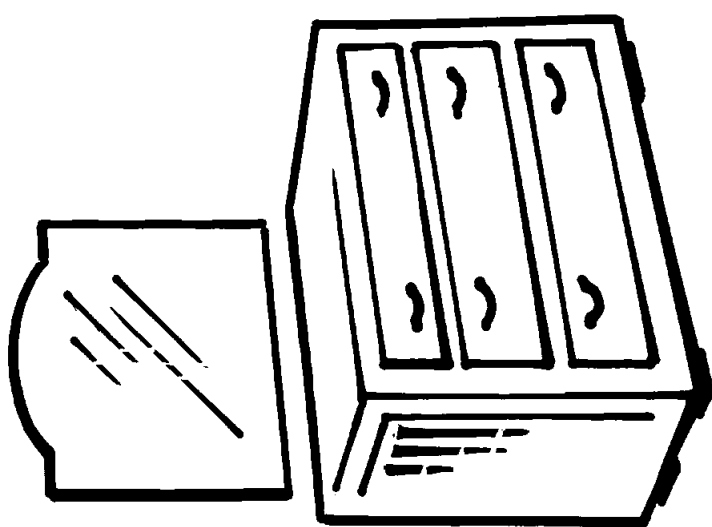
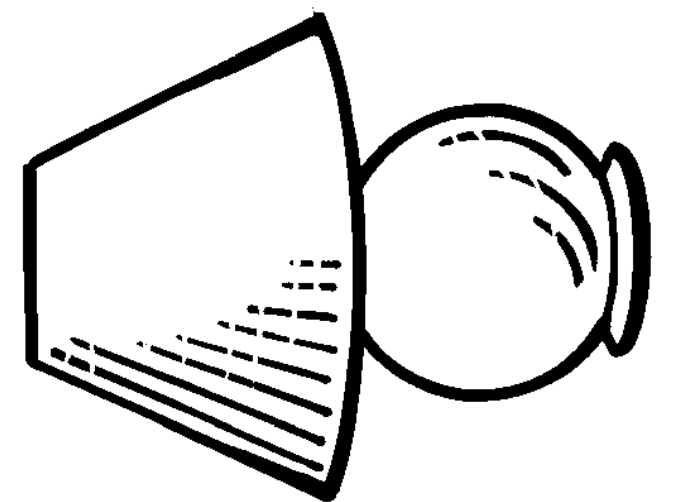
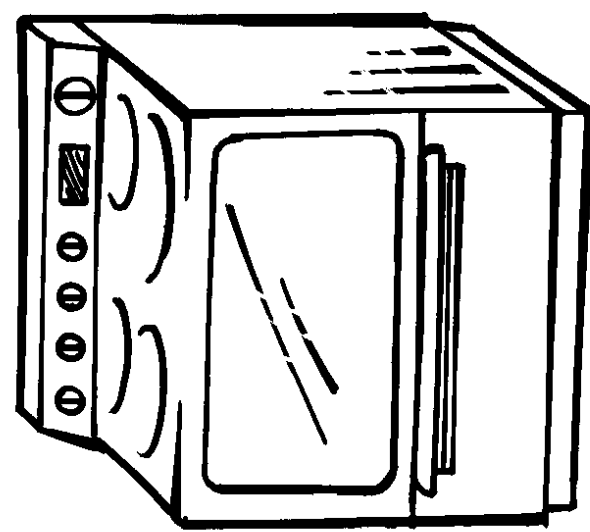
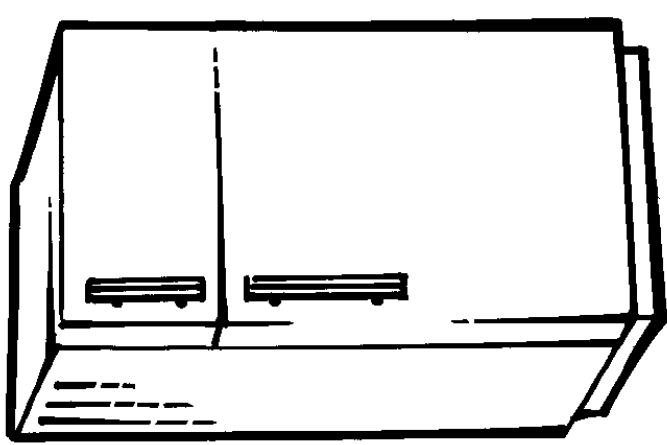
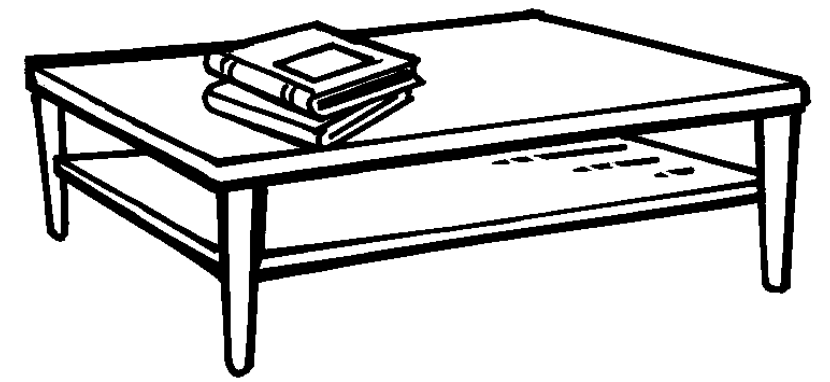
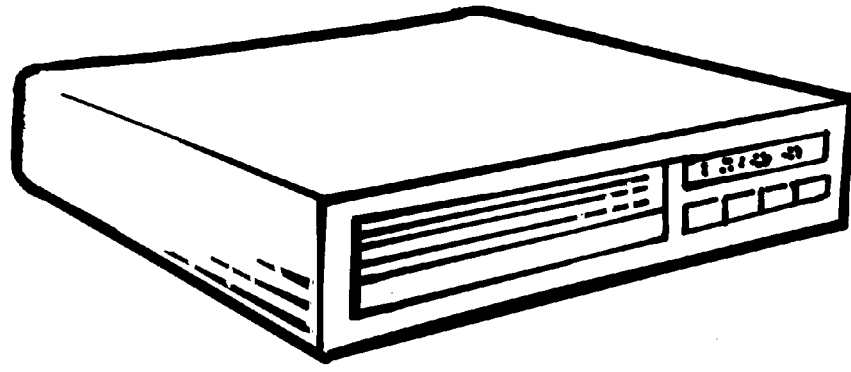
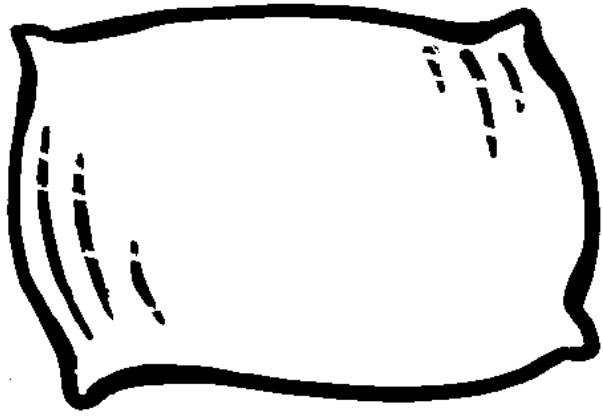
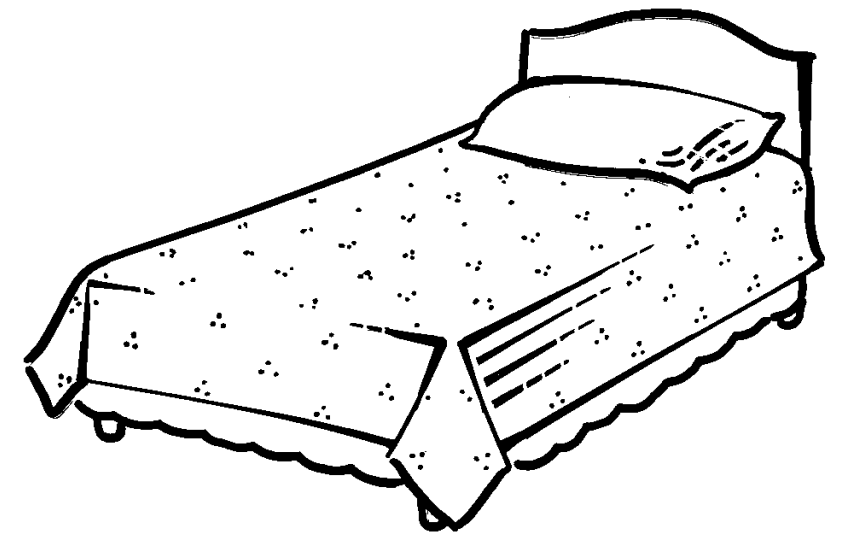
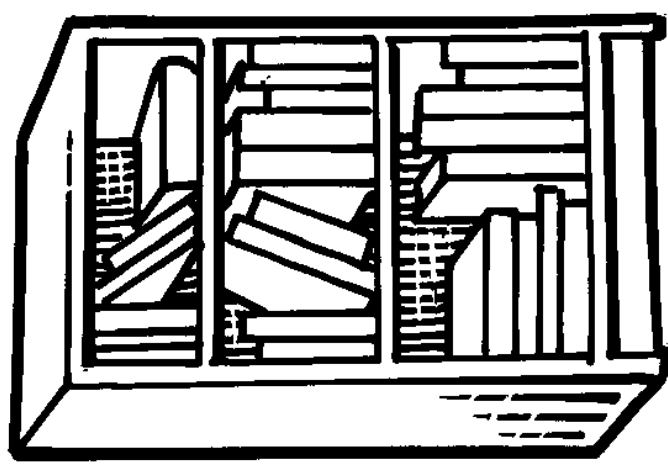
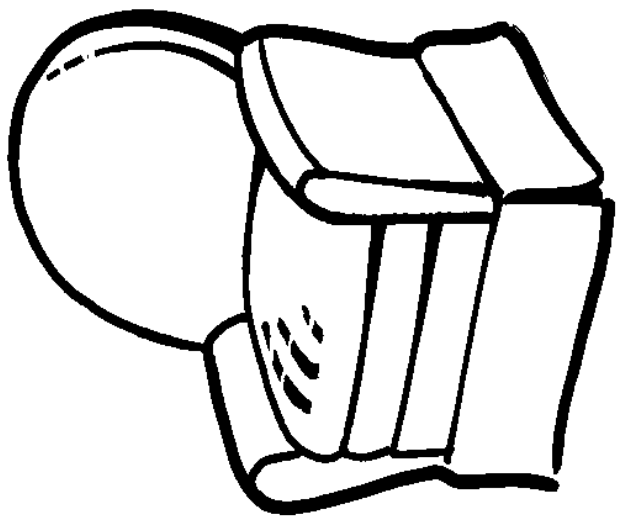



a b c d e f g h i j k l m n o p q r s t u v w x y z !

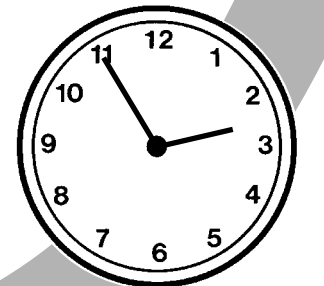
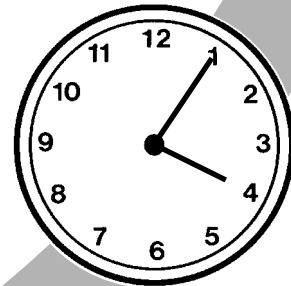
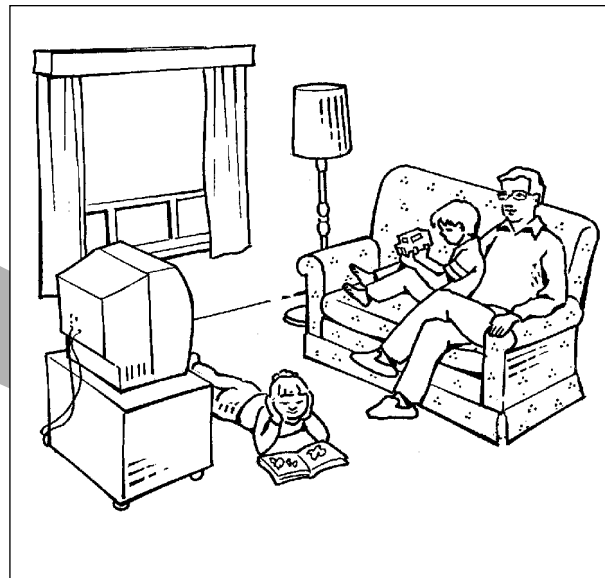
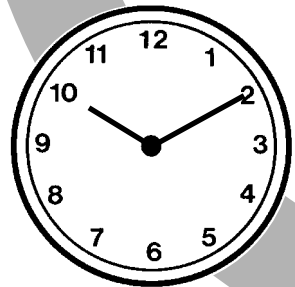
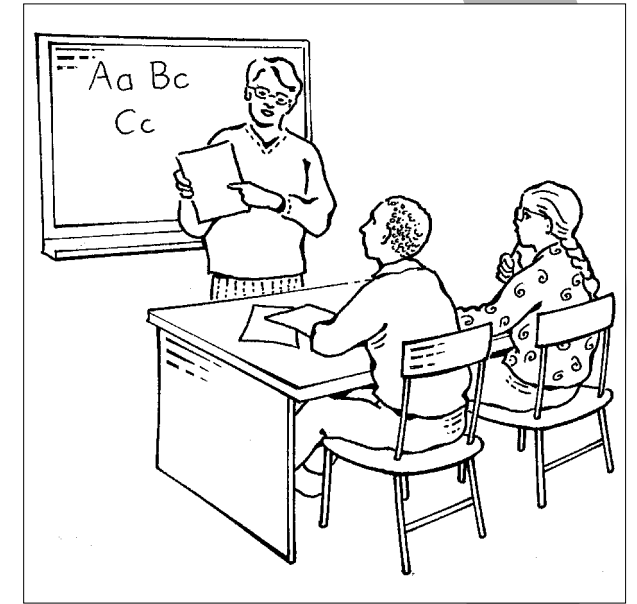
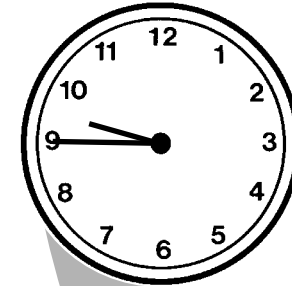
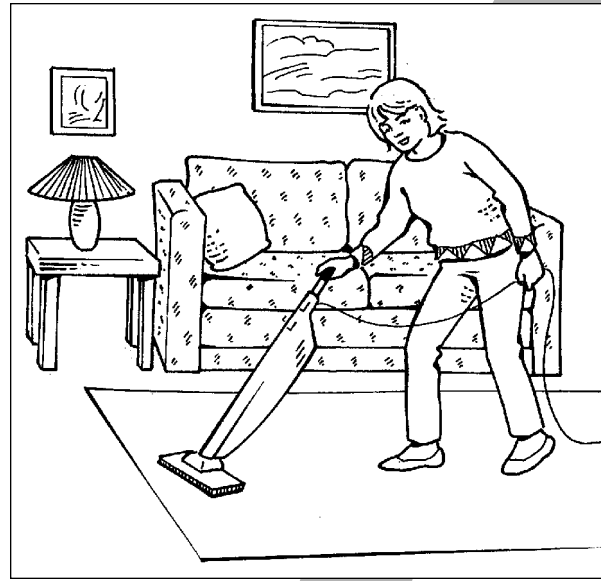
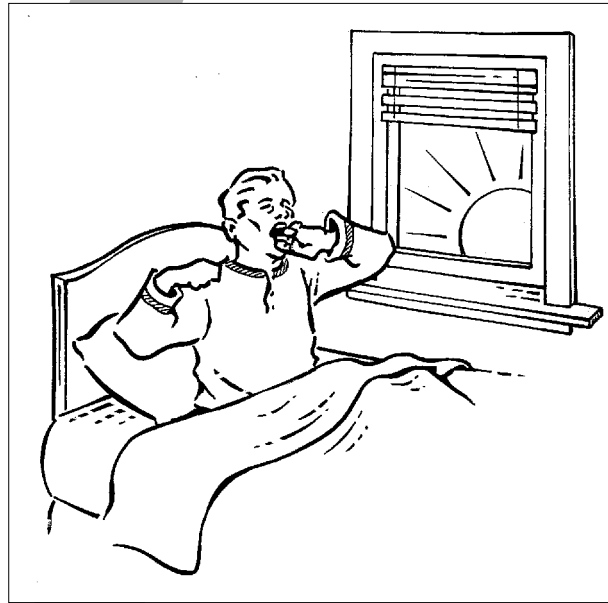
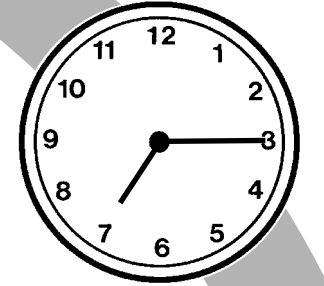
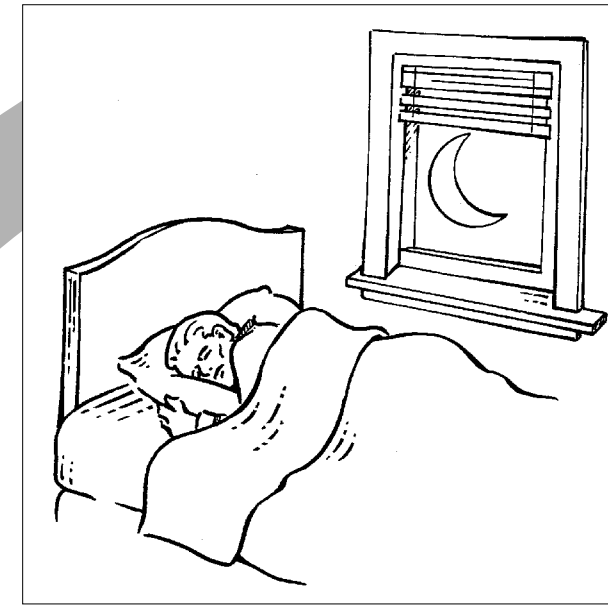
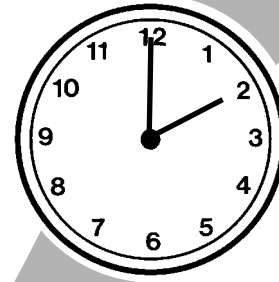
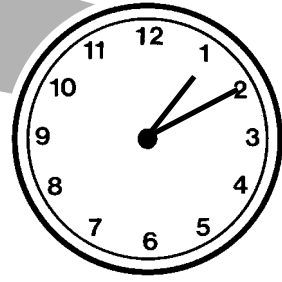
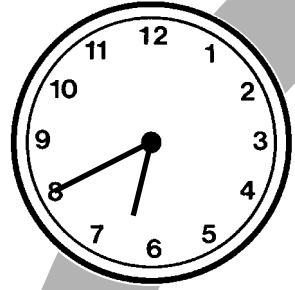

Selected ESL Literacy Resources

The following is a list of resources that have been helpful both in the development of these materials and in working with ESL literacy learners. This is in no way meant to be a complete list, but rather a list of accessible resources. Many of these resources were gathered for the research of this book and are available from the Halifax Immigrant Learning Centre.

ESL Literacy Books

Cunningham, Helen. (1986). *Having a Baby: An ESL Workbook*. Vancouver Community College English as a Second Language Division.

This illustrated workbook contains vocabulary, dialogues, and exercises to help pregnant women interact with health professionals. Available from Vancouver Community College, King Edward Campus Bookstore, 1155 East Broadway, Vancouver, B.C. V5T 1Y8 fax: (604)871-7311 phone: (604)871-7333 \$7.50 + GST.

House, Jennifer and Rabinowitz, Myrna. (1986). *The Post Office: An ESL Workbook*. Vancouver Community College English as a Second Language Division.

This illustrated workbook contains vocabulary, dialogues, and exercises to help newcomers use and understand the postal system. Available from Vancouver Community College, King Edward Campus Bookstore, 1155 East Broadway, Vancouver, B.C. V5T 1Y8 fax: (604)871-7311 phone: (604)871-7333 \$7.50 + GST.

Rabinowitz, Myrna. (1986). *Having an Operation: An ESL Workbook*. Vancouver Community College English as a Second Language Division.

This illustrated workbook contains vocabulary, dialogues, and exercises relevant to having an operation. Available from Vancouver Community College, King Edward Campus Bookstore, 1155 East Broadway, Vancouver, B.C. V5T 1Y8 fax: (604)871-7311 phone: (604)871-7333 \$7.50 + GST.

Wong Nishio, Yvonne. (1998). *Longman ESL Literacy, Second Edition*. Addison Wesley Longman Inc. New York.

This book was created specifically for true beginners. It provides a basic introduction to English for students who are not ready for Level 1. It features life-skill competencies and low-level grammar in ten topically organized units..

Wong Nishio, Yvonne. (1998). *Longman ESL Literacy Teacher's Resource Book, Second Edition*. New York.

Includes step-by-step lesson plans, reproducible flash cards, activities, readings, and tests.

Numeracy

Ciancone, Tom & Jay, Cellan. (1991). *Planning Numeracy Lessons for an ESL Literacy Classroom*. Toronto Board of Education Toronto, Ontario.

Available from the Toronto District School Board Bookstore: Curriculum Division, 155 College St. 6th floor, Toronto, Ontario M5T 1P6 phone: (416)397-3777 Or (416)393-9948. Fax: (416)393-9952. \$10.00

Dondertman, Betty & Ciancone, Tom. (1991). *Numbers in Our Lives: Numeracy Methods and Materials*. Toronto Board of Education Toronto, Ontario. Available from the Toronto District School Board Bookstore: Curriculum Division, 155 College St. 6th floor, Toronto, Ontario M5T 1P6 phone: (416)397-3777 Or (416)393-9948. Fax: (416)393-9952.

Greig, David. (1995) *Sequential Core Basics*. Toronto Board of Education Toronto, Ontario. A set of five books with exercises for spelling, grammar, reading and writing. Photocopiable. Available from the Toronto District School Board Bookstore: Curriculum Division, 155 College St. 6th floor, Toronto, Ontario M5T 1P6 phone: (416)397-3777 Or (416)393-9948. Fax: (416)393-9952. \$90.00

Lucas, Kathleen, Dondertman, Betty & Ciancone, Tom. (1991). *A Sequencing Guide for Numeracy: Whole Numbers*. Toronto Board of Education Toronto, Ontario. Available from the Toronto District School Board Bookstore: Curriculum Division, 155 College St. 6th floor, Toronto, Ontario M5T 1P6 phone: (416)397-3777 Or (416)393-9948. Fax: (416)393-9952. \$10.00

Reference

Andreini, Lorilee. (1992). *Adult ESL Literacy in the United States: Developing a Learner-Centered Approach*. Master's Thesis, University of Northern Iowa.

Auerbach, Elsa Roberts. (1992). *Making Meaning Making Change: Participatory Curriculum Development for Adult ESL Literacy*. McHenry, IL and Washington, DC: Delta Systems and Center for Applied Linguistics.

Bell, Jill & Burnaby, Barbara. (1990). *A Handbook for ESL Literacy*. Markham, Ontario: OISE Press.

Colman, Judy & Schiffmann, Jill. (1993). *Teaching ESL Literacy to Adults: A Guide for Adult Literacy Teachers*. Language training Centre University of New England Armidale NSW 2351.

Dartmouth and Area Literacy Association. (1997). *Handbook for Lifelong Learners*. Available from The Dartmouth and Area Literacy Association, P.O. Box 1004, Dartmouth, NS, B2Y 3Z9. \$12.00

English as a Second Language Tutor Survival Kit (1994). A collection of collaborative activities that can provide fun and adventure during the journey involved in acquiring English as a Second Language. Available from Literacy Volunteers of America. 1-800-582-8812. \$6.95 US. #91036

Gaber-Katz, Elaine & Zettel, Kathryn. (1990). *Guide to Resources for ESL Literacy Facilitators*. Toronto Board of Education, Continuing Education Department.

Huntly, Helen. (1992). *The New Illiteracy: A Study of Pedagogic Principles of teaching English as a Second Language to Non-Literate Adults*. Ohio Program of Intensive English, Ohio University.

Literacy Works Vol. 6, No. 1, Mother Tongue Literacy, A Quarterly Publication of the Saskatchewan Literacy Network. Winter 1995-95. Individual issues of Literacy Works may be purchased for \$5.00 (includes tax). Subscriptions are \$30. Saskatchewan Literacy Network. P.O. Box 1520, Saskatoon, Saskatchewan, S4T 2R3.

Mikulecky, Larry, Lloyd, Paul & Huang, Shenghui. *Adult ESL Literacy Learning Self-Efficacy Questionnaire*. Language Education Department, Indiana University at Bloomington.

Articles

Alpha Ontario. (March 1998) ESL Literacy Quick List #29. A list of recent and older ESL literacy materials available from Alpha Ontario.

Ciancone, Tom (1996). Numeracy in the Adult ESL Classroom. ERIC Digest .

Huerta-Macias, Ana. (1993). Current Terms in Adult ESL Literacy. ERIC Digest.

Kessler, Carolyn, Cohen, Barbara & Walsh, Rachel. (1996). Classroom Interaction for Adult Literacy. Report from the 2nd International Conference on Teacher Education, Teacher Education: Stability, Evolution & Revolution. Netanya, Israel.

Klassen, Cecil & Burnaby, Barbara. (1993). "Those Who Know": View on Literacy Among Adult Immigrants in Canada. TESOL Quarterly Vol. 27.

Massey Holt, Grace (1995). Teaching Low-Level Adult ESL Learners. ERIC Digest.

McGroarty, Mary. (1993). Cross-Cultural Issues in the Adult ESL Literacy Classroom. ERIC Digest.

Peyton, Joy & Crandall, JoAnn. (1995). Philosophies and Approaches in Adult ESL Literacy Instruction. ERIC Digest.

Rousos, Linda. (1991). Individual ESL Literacy Instruction for Refugees: report on MPAEA Innovative Grant Project Pima County Adult Education. Tucson, Arizona.

Weinstein, Gail. (1998). Q & A Family and intergenerational Literacy in Multilingual Communities. ERIC

Digest.

Wiley, Terrance. (1997). Myths about Language Diversity and Literacy in the United States. ERIC Digest.

Website Addresses

National Clearinghouse on Literacy Education
http://www.ed.gov/databases/ERIC_Digests/index/

National Clearinghouse for ESL Literacy Education (NCLE)
<http://www.cal.org/ncle/>

National Adult Literacy Database (NALD)
<http://www.nald.ca>

Alpha Ontario: The Literacy and Language Training Resource Centre
<http://alphaont.ca>

Other Resources:

Alphabet panel (Scholars Choice \$16.99)
Alphabet desk cards (Scholars Choice \$4.50)
100 number board activities (Scholars Choice \$19.99)
Clock face stamp (Kool & Galt \$6.90)
Canadian coin stamps (Kool & Galt 11.76)
Canadian money bingo (Scholars Choice \$14.99)
Tactile numbers (Scholars Choice \$9.95)

The above prices are 1998 prices. Tax is not included.

Kool & Galt
180 Middlefield Rd., Scarborough, Ontario M1S 4M6
phone: (416)293-0312

Scholars Choice
MicMac Mall, Dartmouth, Nova Scotia
phone: 1-800-249-8888